



Liebert[®] Touchscreen Control Panel

User Manual

For EXM, EXM2, APM160, APM300-600, EPM300-600

The information contained in this document is subject to change without notice and may not be suitable for all applications. While every precaution has been taken to ensure the accuracy and completeness of this document, Vertiv assumes no responsibility and disclaims all liability for damages resulting from use of this information or for any errors or omissions. Refer to other local practices or building codes as applicable for the correct methods, tools, and materials to be used in performing procedures not specifically described in this document.

The products covered by this instruction manual are manufactured and/or sold by Vertiv. This document is the property of Vertiv and contains confidential and proprietary information owned by Vertiv. Any copying, use or disclosure of it without the written permission of Vertiv is strictly prohibited.

Names of companies and products are trademarks or registered trademarks of the respective companies. Any questions regarding usage of trademark names should be directed to the original manufacturer.

Technical Support Site

If you encounter any installation or operational issues with your product, check the pertinent section of this manual to see if the issue can be resolved by following outlined procedures.

Visit <https://www.vertiv.com/en-us/support/> for additional assistance.

TABLE OF CONTENTS

1 Introduction	1
2 Navigating Through The Touchscreen Control Panel	3
2.1 Access Level Log-In	3
2.2 Default PIN's and Authority to Change PIN's	4
2.3 Touchscreen Control Panel Components	4
2.3.1 Context Menus	6
2.4 SYSTEM PANE—Mimic Display Components	10
2.4.1 UNIT STATUS Pane Components	13
2.5 Customizing the Display	17
2.5.1 Remove a Layout	21
2.5.2 Using the Edit Icon to Customize Layout	21
2.5.3 Edit the UNIT STATUS Panel with the Edit Icon	24
2.5.4 Setting DISPLAY PROPERTIES	25
2.5.5 Setting Date, Time and Time Zone	25
2.6 Changing Date, Time and Measurement Formats	30
2.6.1 Change the Date Format	30
2.6.2 Change the Time Format	30
2.6.3 Change the Measurement System	30
2.7 Create or Modify Custom Labels	31
3 Operation	35
3.1 Log In to the Touchscreen Control Panel	35
3.2 Operator Controls	35
3.2.1 LIFE™ Services	36
3.3 OPERATE Menu Commands	36
3.3.1 Silence an Alarm	37
3.3.2 Inverter On	37
3.3.3 Inverter Off	39
3.3.4 Reset Fault	40
3.3.5 Suspended Time Remaining	40
3.3.6 Module Redundancy Status	40
3.3.7 Energy Saving Mode Activation	42
3.4 Audible Alarm Enabled or Disabled	44
3.5 LIFE™ Services—Context Menu and LIFE Services Function Menu	45
4 Viewing UPS Status	47
4.1 Viewing UPS Data with the Status Gauge	47
4.2 Viewing UPS Data with the Status Panel	50
4.3 Logs—Events and Log-In Times	55
4.3.1 Logs—Filtering and Sorting Events	57
4.3.2 Logs—Exporting Event and Audit Logs	58

5 Viewing UPS Component Status	61
6 Parallel System	65
6.1 Parallel System Mimic	65
7 Status Bar Composition	71
7.1 Status Bar Messages	71

1 Introduction

The Touchscreen Control Panel's integrated interface simplifies monitoring and managing single or multiple Liebert UPS modules. The control collects a profusion of information about the health of the modules and presents it in a standardized format. This simple, dynamic display speeds operator response to changing power input and demand.

Many of the settings will depend on the UPS type and features. Many other settings will be made during the UPS setup by Vertiv personnel.

The Touchscreen Control Panel's interface will display data either graphically or in text. The Status Scroll Bar at the top of the touchscreen display summarizes system conditions. The bar changes color to indicate status and includes an icon matched to the status. The Status Gauge displays such details as power demand from the connected load, input power quality, output and bypass on each phase and battery capacity.

The Touchscreen Control Panel's mimic display shows the comprehensive system information that the operator needs:

- Is input power connected?
- Are there any alarms?
- Which breakers are open and which are closed?
- Is the UPS on battery?
- How much battery run time is available?

Checking a particular component is as simple as touching it on the mimic display—Detailed data appears, allowing the operator to respond.

Visual and audible alarms alert personnel to faults and alarms requiring immediate attention.

Passcodes for each level of access—Operator, Administrator and Service—secure the UPS against unauthorized changes. Personnel without a passcode can view UPS status, but cannot change any functions or the appearance of the interface.

Figure 1.1 Touchscreen Control Panel Components

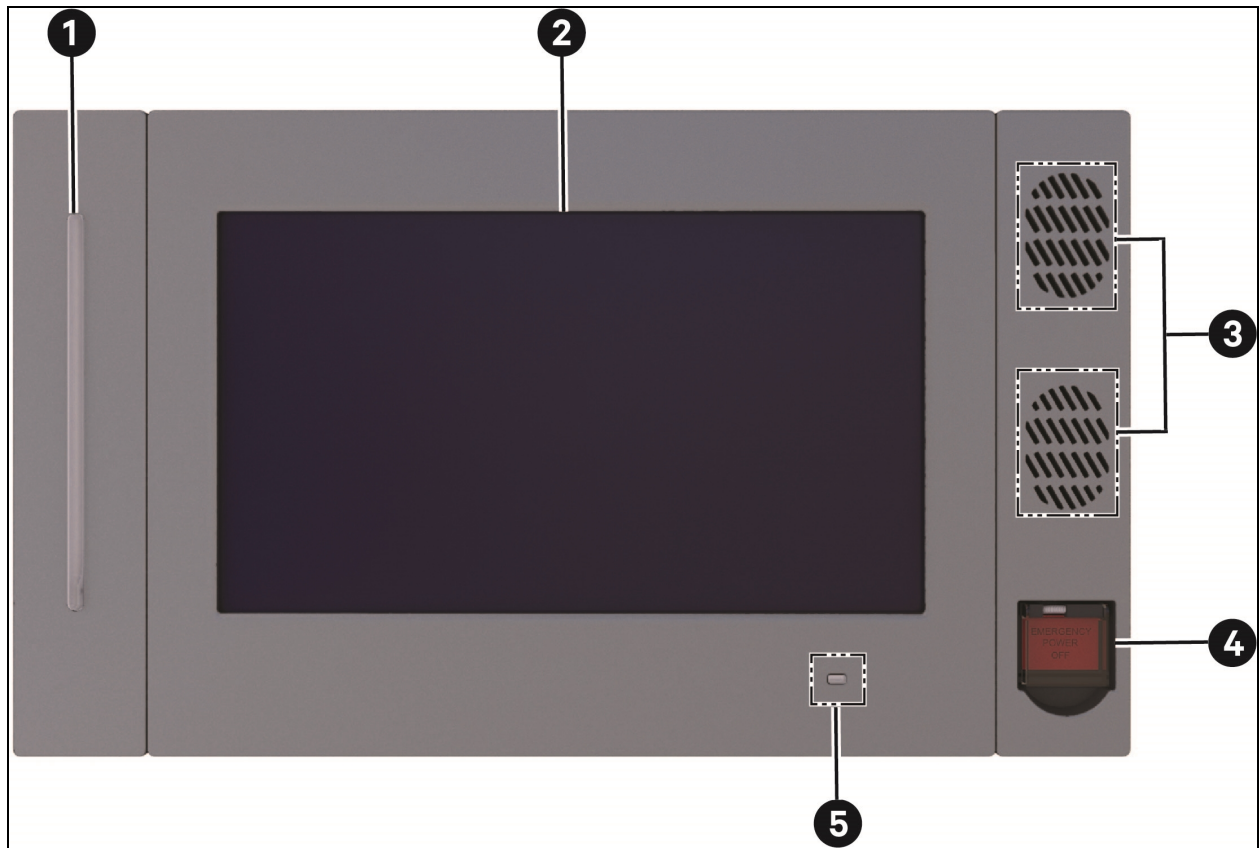

ITEM	DESCRIPTION
1	UPS Status LED
2	Touchscreen LCD
3	Speakers (not used)
4	EPO Switch
5	UPS Status

2 Navigating Through The Touchscreen Control Panel

The Touchscreen Control Panel is active whenever the UPS has input power. The touchscreen LCD on the front of the UPS permits:

- Logging in to the system— see [Log In to the Touchscreen Control Panel](#) on page 35
- Customizing the user interface— see [Customizing the Display](#) on page 17
- Checking the status of the UPS and its external batteries, including all measured parameters, events and alarms— see [Viewing UPS Status](#) on page 47 and [Viewing UPS Component Status](#) on page 61
- Determining when users logged in and out— see [Logs—Events and Log-In Times](#) on page 55
- Silencing alarms— see [Silence an Alarm](#) on page 37
- Turning the UPS On — see [Inverter On](#) on page 37
- Turning the UPS Off— see [Inverter Off](#) on page 39
- Resetting faults— see [Reset Fault](#) on page 40
- Enabling Energy Saving Mode— see [Module Redundancy Status](#) on page 40 and [Energy Saving Mode Activation](#) on page 42

The Touchscreen Control Panel's display default view is two panes: One-line animated mimic and UNIT STATUS. The appearance can be changed to multiple panes that show other data.

Customizing the appearance is detailed in [Customizing the Display](#) on page 17 .

2.1 Access Level Log-In

The Touchscreen Control Panel provides security by limiting the authority to change how the UPS operates. Each of the four access levels offers different authority:

- Observer — Viewing permission only, can choose graphic or text display, view logs and silence alarms; no PIN required
- Operator — Permission to start and shut down the UPS, edit the display layout, test the battery, reset faults, enable or disable Eco Mode operation, enable equalize battery charging and acknowledge alarms; PIN required
- Administrator — All functions of Operator plus permission to change PIN's for Operator and Administrator level, configure the Status Gauge, set energy saving mode and change network communication protocols; PIN required
- Service — All functions of Administrator plus permission to alter system configuration and change Service PIN; PIN required.

2.2 Default PIN's and Authority to Change PIN's

Vertiv sets PIN's when setting up the UPS. These default PIN's may be changed by those with Administrator or Service access (see above). Default PIN's are:

- **Operator:** 1234
- **Administrator:** 2345

NOTICE

Risk of unauthorized changes to operational settings. Can cause equipment damage.

The default PIN numbers should be changed immediately to prevent unauthorized personnel from changing UPS operation or even shutting down the UPS. The PIN's for Operator and Administrator may be changed by logging in with either Administrator or Service level access.

To change a PIN:

- Log into the system with Administrator or Service access.
- Touch the *SETUP Function Menu*.
- Touch the *User Level PIN* to be changed.
- Enter the new *PIN*.
- Touch the *Save* button to save the changes or touch *Cancel* to exit without saving.

NOTE: Vertiv recommends recording PIN's for Service and Administrator if they are changed and storing the new numbers where they are accessible if they are forgotten. A user with authority to change a PIN will be able to see PIN's of those with equal or lesser access.

2.3 Touchscreen Control Panel Components

The main areas of the Touchscreen Control Panel are shown in **Figure 2.1** on the facing page . The display arrangement and the information displayed can be changed.

At log-in for all access levels, the Touchscreen Control Panel opens to the STATUS screen in graphic display. The STATUS screen will show the animated mimic and system status readings at each log-in level. The appearance will differ only in the function menus displayed

(see **Figure 2.2** on page 6).

Figure 2.1 Interface Overview—STATUS Screen; Graphic Display

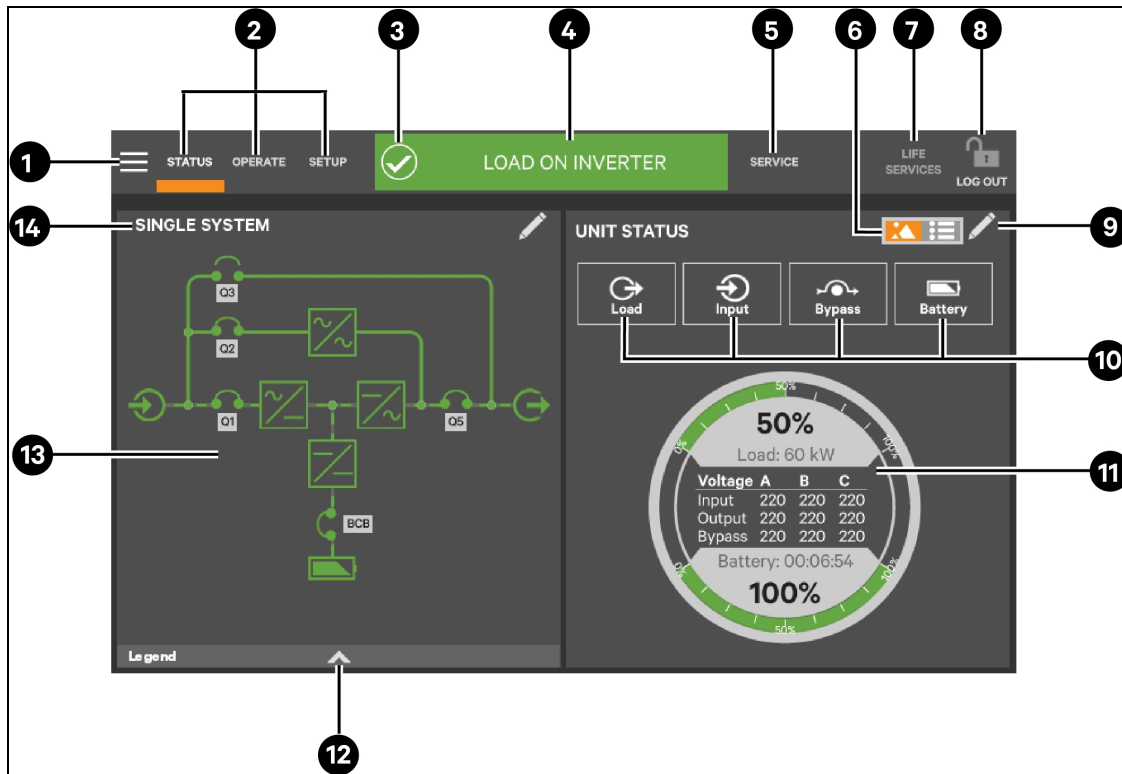

ITEM	DESCRIPTION	ITEM	DESCRIPTION
1	Context Menu Icon	8	Log In/Out Icon
2	Function Menu Icons (Varies by access level)	9	Edit Interface Icon
3	Status Bar Icon	10	Parameter Icons (Maximum of four if the Status Gauge is
4	UPS Status Bar (Scrolls through status information)	11	Status Gauge
5	Function Menu Icon	12	Legend Drawer (See Figure 2.4 on page 10)
6	Graphic or Text Interface Switch	13	Animated Mimic Display
7	LIFE Services Menu Icon	14	System link (When active, output shows system values)

Figure 2.2 Control Display by Access Level

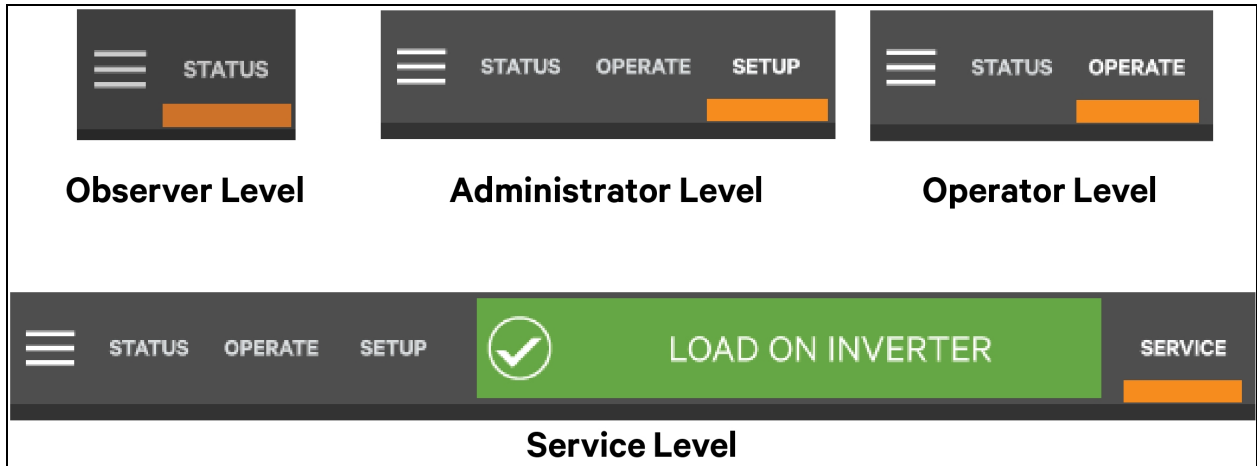

Each Function Menu offers different information and control choices. The Function Menu displayed is tied to the user’s access level. For example, logging in as an Operator will not show the SETUP or SERVICE function menus, while logging in as Administrator will show the STATUS, OPERATE, SETUP and LIFE Services function menus (see **Figure 2.2** above).

- **STATUS:** Condition of the UPS components and data affecting operation and performance; visible at all access levels.
- **OPERATE:** UPS operation controls, such as Inverter On, Inverter Off and Energy Saving Status; visible to Operator, Administrator and Service
- **SETUP:** Manage permissions through PIN’s; visible to Administrator and Service
- **SERVICE:** Input wiring and breaker configuration, protocol used and battery charging method; visible only to Service
- **LIFE Services:** Information for assistance to enable LIFE customer care. LIFE Services requires a maintenance contract. The service must be activated with assistance by calling the listed telephone number; visible to all, including Observers.



Function menu icons are white when selected, except the LIFE Services icon; it remains dark gray

2.3.1 Context Menus

The Context Menu, available by touching the Menu icon at the top left corner of the interface, display information about the UPS and permit changing various settings. The functions possible through the Context Menu are determined by the user’s access level and on the Function Menu that is active (see **Figure 2.3** on the facing page).

The items under Display Options on the STATUS Context Menu, for example, differ for each access level.

Some information that is available through the Context Menu, such as alarms and run hours, are also available through other areas of the Touchscreen Control Panel.



NOTE: The LIFE Services Function Menu icon has no associated Context Menu. Commands and operations related to LIFE Services are found on the OPERATE Context Menu.

Figure 2.3 Context Menus

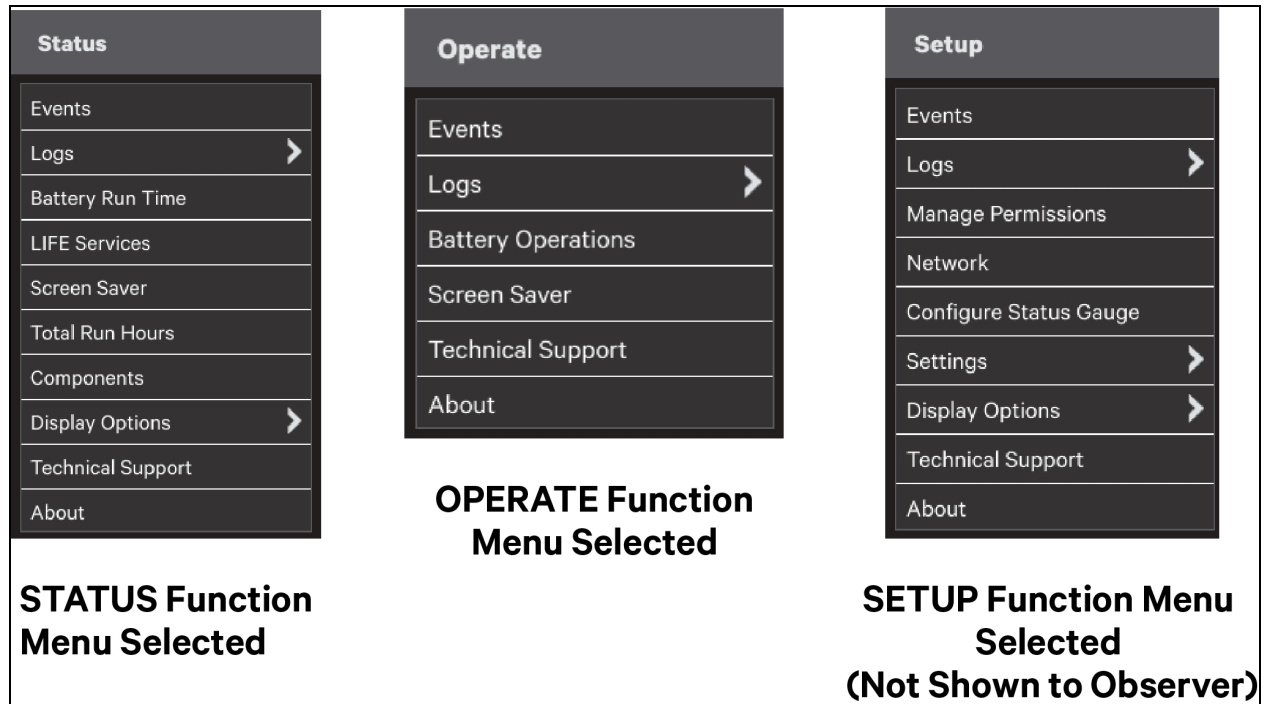

Context Menus-Status

Selecting the STATUS icon and touching the Menu icon reveals a Context Menu that permits performing several actions or accessing additional information (see **Figure 2.3** above). Touching a Context Menu item will reveal data or expand the menu to show additional options.

The Context Menu for the STATUS icon shows these items:

- **Events:** Date and time of occurrence, type of event, Event ID, component affected and description; same options for all access levels, except Observers cannot acknowledge alarms. Events can be sorted by type, event ID, component, description. The touchscreen also permits filtering events by severity (Status, Alarm or Fault); or by component (bypass, monitoring process or the module where the event occurred).
 - **Status:** Information about the configuration and operating condition of components.
 - **Alarm:** Warnings or cautions signifying an abnormal state of a component. A component may be operating, but may not be functioning correctly.
 - **Fault:** A serious and critical failure has occurred in a component. Some, but not all, faults are latching.
- **Logs:** UPS Event Log and Audit Log
 - **UPS Event Log** shows date and time of event occurrence, type of event, Event ID, status. component affected and description; same options for all access levels. All levels, including Observer, can export the Event Log as a CSV file for record-keeping, analysis and similar uses.
 - **Audit Log** shows date and time users with UPS control access logged into and out of the system; Observer is not logged. All levels, including Observer, can export the Audit log as an XML or CSV file for record-keeping, analysis and similar uses.
- **Battery Run Time:** Battery Cycle Monitor with duration and count; same options for all access levels

- **Screen Saver:** Display Sleep Mode notification (immediate entry into screen saver); screen goes dark and user is logged off; interface reactivated by touching the screen; same options for all access levels
- **Total Run Hours:** Component and hours it has operated; touching a component displays details in the right panel.
- **Components:** Component status, name and details
- Display Options (Changes affect view for all access levels)
 - **Customize Layout:** Change panel content and layout (see [Customizing the Display](#) on page 17); not available to Observer
 - **Display Properties:** Language, theme (colors for the interface; Dark_Gray_9 is the default), back-light timer, alarm timeout, auto-log-out timer, display brightness, status indicator brightness and touchscreen calibration (see [Customizing the Display](#) on page 17); only language and display brightness are available to Observer
 - **Date & Time:** Drop-down lists for time zone, date, local time and UTC time (Coordinated Universal Time) (see [Customizing the Display](#) on page 17); not available to Observer
 - **Formats:** Drop-down lists for date and time format and measurement system (metric or imperial) (see [Customizing the Display](#) on page 17)
 - **Custom Labels:** Rename settings, serial ports and network interfaces to ease troubleshooting and refine data. (The default name of COM1 may be adequate, but renaming it with the connected device may ease determining the cause of an alarm).
- **Technical Support:** Manufacturer's support: Web site, e-mail address and telephone numbers
- **About:** Information about the UPS and its software and firmware; UPS model, rating, configured capacity, model number and serial number.

Context Menu—OPERATE

Selecting the OPERATE icon and touching the Menu icon reveals a Context Menu that permits performing several actions or accessing additional information (see **Figure 2.3** on the previous page). Touching a Context Menu item will reveal data or expand the menu to show additional options.

The Context Menu for the OPERATE icon shows these items:

- **Events:** Date and time of occurrence, type of event, Event ID, component affected and description; same options for all access levels, except Observers cannot acknowledge alarms. Events can be sorted by type, event ID, component, description. The touchscreen also permits filtering events by severity (Status, Alarm or Fault); or by component (bypass, monitoring process or the module where the event occurred).
- **Logs:** UPS Event Log and Audit Log
 - **UPS Event Log** shows date and time of event occurrence, type of event, Event ID, status, component affected and description; same options for all access levels. All levels, including Observer, can export the log as a CSV file for record-keeping, analysis and similar uses.
 - **Audit Log** shows date and time users with control of UPS functions logged into and out of the system; Observer is not logged. All levels, including Observer, can export the log as an XML or a CSV file for record-keeping, analysis and similar uses.
- **Battery Operations:** Battery testing and charging; automatic, manual and calibration battery testing and battery equalize charging.
- **LIFE Services:** Customer care assistance contact and reporting center; must be activated with assistance by calling the listed telephone number;
- **Screen Saver:** Display Sleep Mode notification (immediate entry into screen saver); screen goes dark and user is logged off; interface reactivated by touching the screen; same options for all access levels
- **Technical Support:** Manufacturer's support: Web site, e-mail address and telephone numbers

- **About:** Information about the UPS and its software and firmware; UPS model, rating, configured capacity, model number and serial number.

Context Menu—SETUP

Selecting the SETUP icon and touching the Menu icon reveals a Context Menu that permits performing several actions or accessing additional information (see **Figure 2.3** on page 7). Touching a Context Menu item will reveal data or expand the menu to show additional options.

The Context Menu for the SETUP icon shows these items:

- **Events:** Date and time of occurrence, type of event, Event ID, component affected and description; same options for all access levels, except Observers cannot acknowledge alarms. Events can be sorted by type, event ID, component, description. The touchscreen also permits filtering events by severity (Status, Alarm or Fault); or by component (bypass, monitoring process or the module where the event occurred).
- **Logs:** UPS Event Log and Audit Log
 - **UPS Event Log** shows date and time of event occurrence, type of event, Event ID, status, component affected and description; same options for all access levels. All levels, including Observer, can export the log as a CSV file for record-keeping, analysis and similar uses.
 - **Audit Log** shows date and time users with control of UPS functions logged into and out of the system; Observer is not logged; Operator, Administrator and Service levels can export the log as an XML or a CSV file for record-keeping, analysis and similar uses.
- **Manage Permissions:** Change PIN for users of equal or lower access levels
- **Network:** Modify communication settings
- **Configure Status Gauge:** Modify information shown on Status Gauge
- **UPS Settings:** Enable or disable audible alarm, enable or disable module redundancy and modify energy saving configuration (Eco Mode or Intelligent Parallel)
- **Display Options** (Changes affect view for all access levels):
 - **Customize Layout:** Change panel content and layout (see - [Customizing the Display](#) on page 17); not available to Observer
 - **Display Properties:** Language, back-light timer, alarm timeout, auto-log-out timer, display brightness, status indicator brightness and touchscreen calibration (see [Customizing the Display](#) on page 17); language and display brightness only are available to Observer
 - **Date & Time:** Drop-down lists for time zone, date, local time and UTC time (Coordinated Universal Time) (see - [Customizing the Display](#) on page 17); not available to Observer
 - **Formats:** Drop-down lists for date and time format and measurement system (metric or imperial) (see - [Customizing the Display](#) on page 17)
 - **Custom Labels:** Rename settings, serial ports and network interfaces to ease troubleshooting and refine data. (The default name of COM1 may be adequate, but renaming it with the connected device may ease determining the cause of an alarm).
- **Technical Support:** Manufacturer's support: Web site, e-mail address and telephone numbers
- **About:** Information about the UPS and its software and firmware; UPS model, rating, configured capacity, model number and serial number.

2.4 SYSTEM PANE—Mimic Display Components

The animated mimic display, the default view for the control, shows each configured major component of the UPS system, for both single-module and multi-module systems. The mimic display is the same for all access levels. The power path is shown by animated lines; moving dashes show the active power path. Touching a component (except a breaker) brings up details about the component’s status. Breakers are shown as open or closed (see **Figure 2.4** below), but they are not interactive.

Components in the mimic display signify their operational status by their color, green, amber or red. **Table 7.1** on page 71 through **Table 7.3** on page 74 describe the various states of the indicators.

The animated mimic display can be changed to any of five other views: Status, Alarms, Run Hours, Event Log and Battery Cycle Monitor Summary (see [Customizing the Display](#) on page 17).

Figure 2.4 Mimic Display, Normal Operation

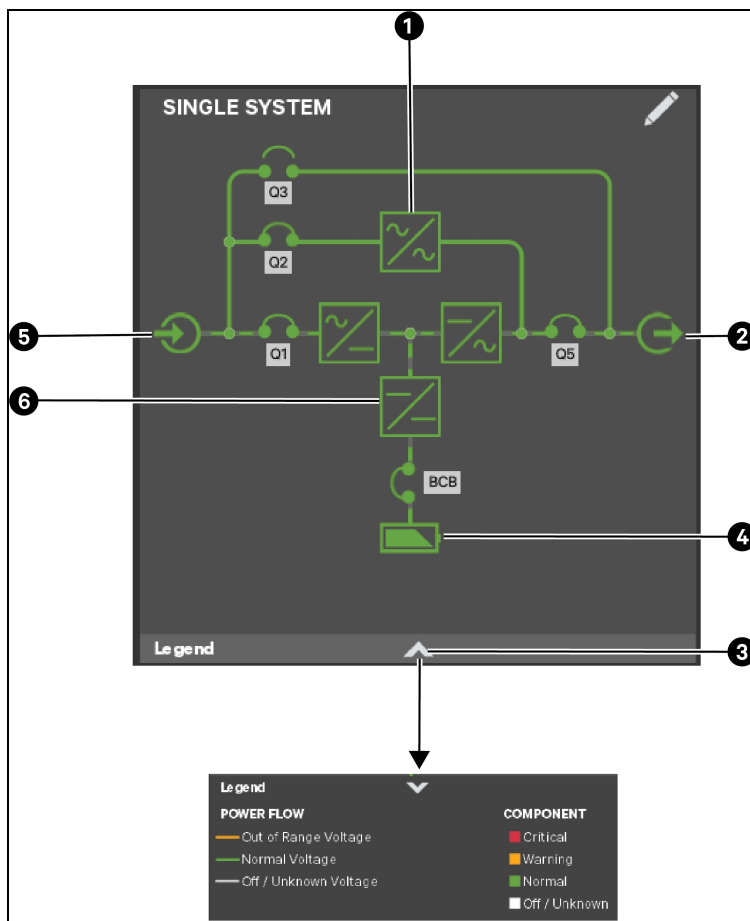

ITEM	DESCRIPTION	ITEM	DESCRIPTION
1	Internal Static Bypass (Interactive)	4	DC Source (Batteries)
2	Output Power (Interactive)	5	Input Power (Interactive)
3	Touching the arrowhead reveals the legend	6	Power Module (Interactive)

Figure 2.5 Parallel System

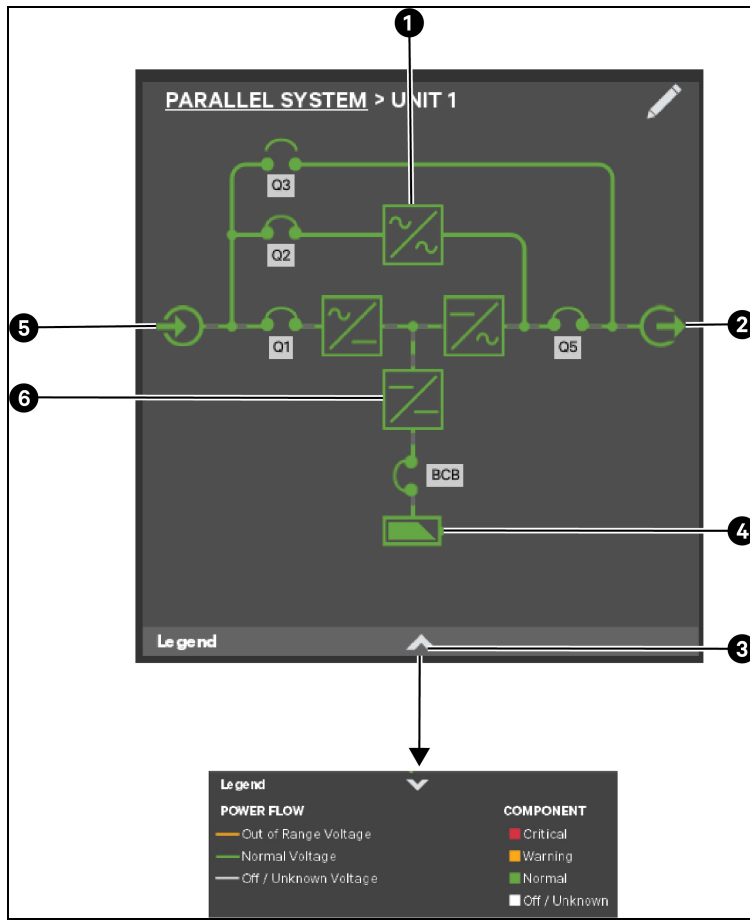

ITEM	DESCRIPTION	ITEM	DESCRIPTION
1	Internal Static Bypass (Interactive)	4	DC Source (Batteries)
2	Output Power (Interactive)	5	Input Power (Interactive)
3	Touching the arrowhead reveals the legend	6	Battery Converter (Interactive)

Figure 2.6 CE Single Unit View Breakers

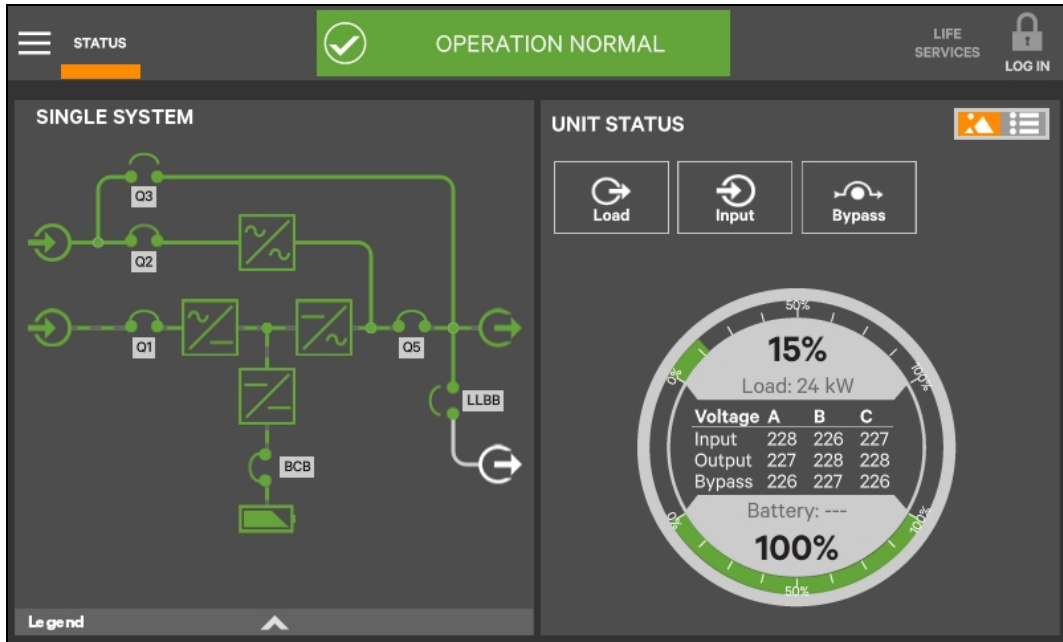

Breaker	Description
Q1	Input Switch/Breaker
Q2	Bypass Switch/Breaker
Q3	Maintenance Bypass Switch/Breaker
Q5	Output Switch/Breaker
LLBB	Local Load Bank Breaker
BCB	Battery Circuit Breaker

NOTE: Breakers in a system are determined during setup and can be installed or removed by Service.[MN1]

Figure 2.7 UL Single Unit View Breakers

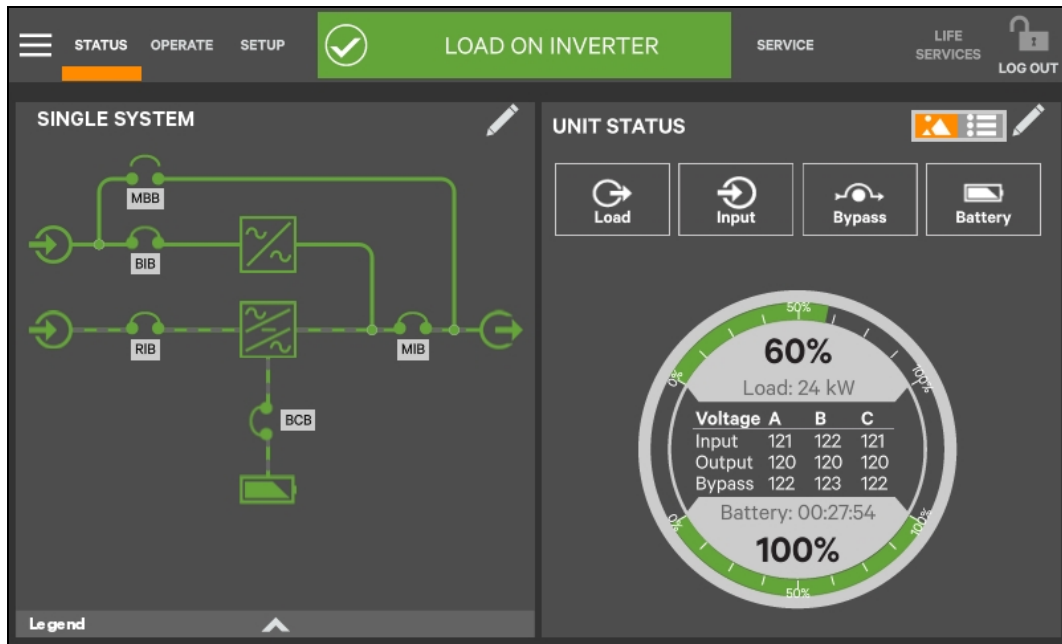

Breaker	Description
RIB	Rectifier Input Breaker
BIB	Bypass Input Breaker
MBB	Maintenance Bypass Breaker
MIB	Maintenance Isolation Breaker
LLBB	Local Load Bank Breaker
BCB	Battery Circuit Breaker

NOTE: Breakers in a system are determined during setup and can be installed or removed by Service.[MN1]

2.4.1 UNIT STATUS Pane Components

The UNIT STATUS pane is identical for all PIN access levels (see **Figure 2.8** on the next page). Observers will not have the pencil edit icon. In the default graphic view, the UNIT STATUS pane shows:

- Status Gauge—Connected load shown in kW and as a percentage of capacity; input, output and bypass voltage for each phase (default data may be changed; see [Viewing UPS Data with the Status Gauge](#) on page 47).
- Input Detail Icon
- Battery Detail Icon
- Bypass Detail Icon
- Load Detail Icon
- Environmental Detail Icon

Touching any of the detail icons reveals additional data about that selection in the opposite pane. The data pane may be closed by touching the Close button or by touching any detail icon. The read-only information is available to all access levels (see **Figure 2.9** on page 15).

NOTE: If the Status Gauge is showing, no more than four detail icons will be visible. Removing the Status Gauge permits showing all five detail icons. The view may be customized to show fewer than four.

Figure 2.8 UNIT STATUS Pane Components

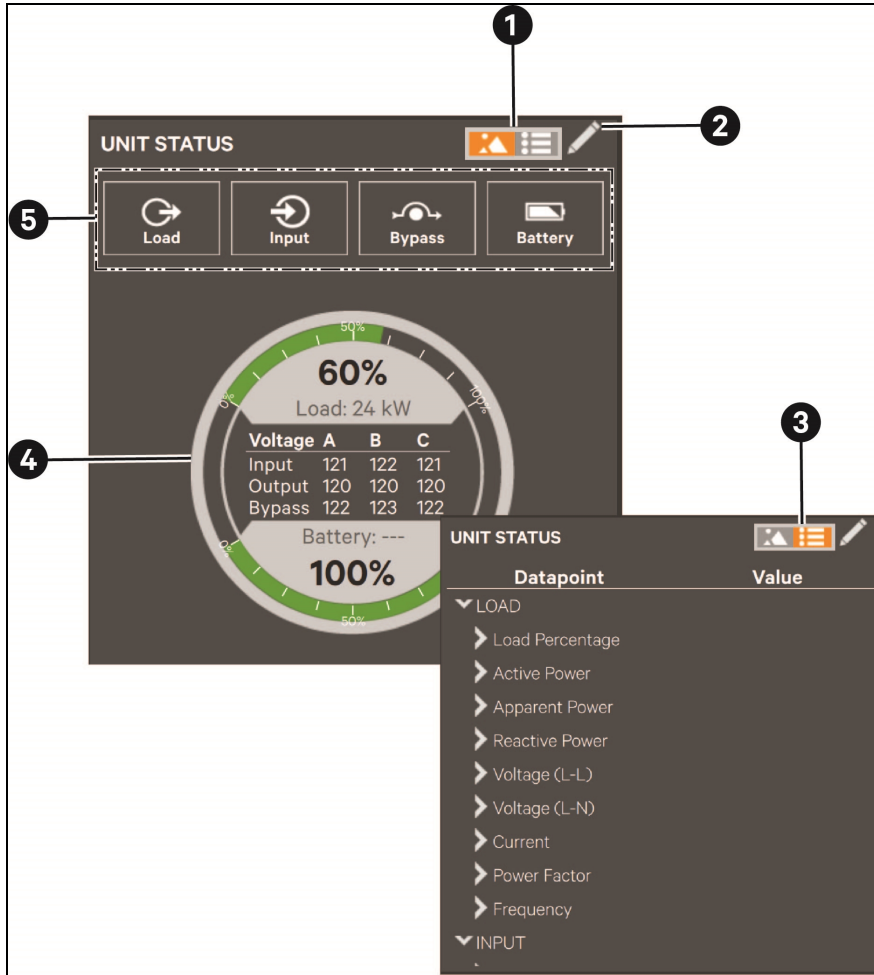

ITEM	DESCRIPTION
1	Touch anywhere on this icon to switch to Text
2	Edit icon (Observers, who have no PIN, will not see the edit icon.)
3	Touch anywhere on this icon to switch to Graphic display mode
4	Status
5	Detail icons for Input, Battery, Bypass and Load (Touch an icon to see details about the linked component [see Figure 2.9 on the facing page].) No more than four detail icons will be visible when the Status Gauge is in Graphic display mode.

Detailed information is shown in text format. The top level is expanded by default, but it can be closed. Scrolling and touching arrowheads will expand or close the corresponding item.

Figure 2.9 UNIT STATUS Pane—Load Details; Graphic Display



ITEM	DESCRIPTION
1	Load detail icon touched to show data in left pane.
2	Touch Close or the Load icon to close the detail pane and return to the animated mimic.

Figure 2.10 UNIT STATUS Pane—Input Details; Graphic Display

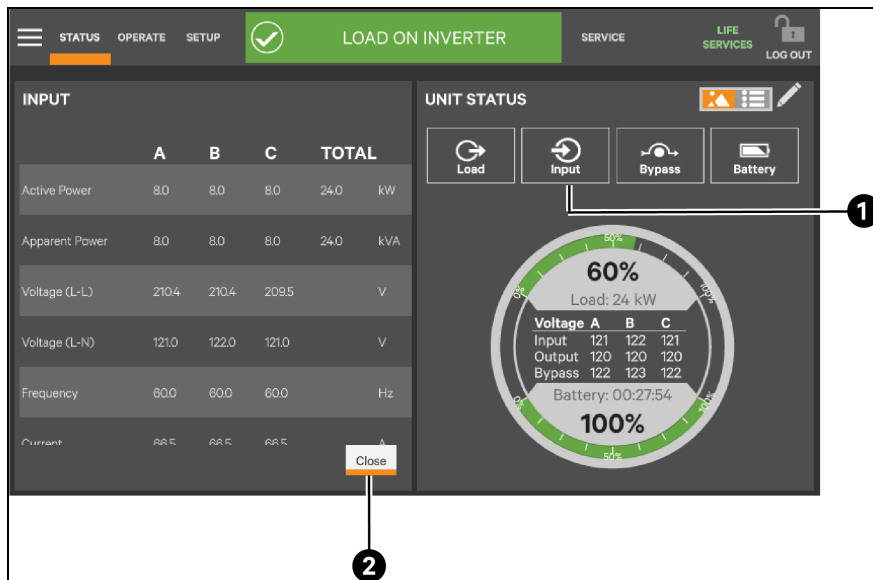

ITEM	DESCRIPTION
1	Input detail icon touched to show data in left pane.
2	Touch Close or the Input icon to close the detail pane and return to the animated mimic.

Figure 2.11 UNIT STATUS Pane—Bypass Details; Graphic Display



ITEM	DESCRIPTION
1	Bypass detail icon touched to show data in left pane.
2	Touch Close or the Bypass icon to close the detail pane and return to the animated mimic.

Figure 2.12 UNIT STATUS Pane—Battery and Cabinet Details; Graphic Display

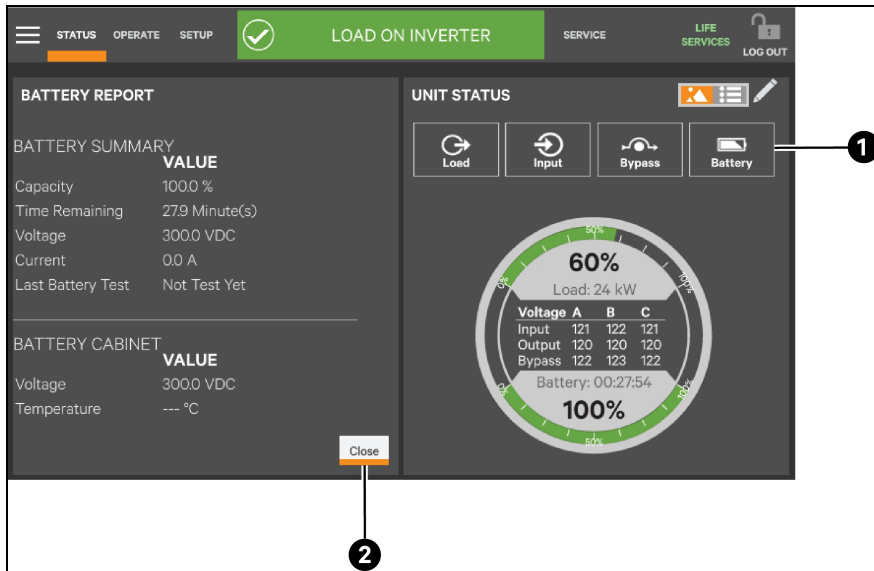

ITEM	DESCRIPTION
1	Battery detail icon touched to show data in left pane.
2	Touch Close or the Bypass icon to close the detail pane and return to the animated mimic.

Figure 2.13 UNIT STATUS Pane—Environmental Details; Graphic Display



ITEM	DESCRIPTION
1	Environmental detail icon touched to show detail in left pane.
2	Touch Close or the Environmental icon to close the detail pane and return to the animated mimic.

2.5 Customizing the Display

The Touchscreen Control Panel's default appearance will be adequate for most installations, but the Status panels can be altered to show additional or different data. Layouts may be chosen by any user with a PIN: Operator, Administrator or Service; the layout chosen will be applied to all users. Layouts may be created or altered only with Administrator or Service Access.

NOTE: The original configuration, Default View 1, cannot be deleted. Editing through the menus will create a new view with the new settings. The Default View 1 can be altered with the pencil edit icon in the display (see [Using the Edit Icon to Customize Layout](#) on page 21).

To customize the display's appearance:

1. Log in to the Touchscreen Control Panel as Administrator or Service detailed in [Log In to the Touchscreen Control Panel](#) on page 35 .
2. From the STATUS view, touch the *Context Menu* icon in the top left corner (shown at right).
3. Select *Display Options > Customize Layout*. (The right pane details how to edit or create a view; see [Customize the Display](#) on page 19 .)



Edit a View

4. Touch a *View* to highlight it.
5. Touch *Edit* to change that view.
6. Alter the layout—Add or remove a panel or associate different options with a panel.
7. Touch the *Save* button to keep your changes or touch *Cancel* to exit without saving.

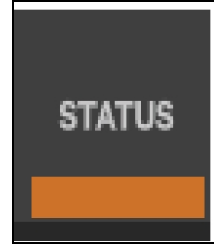

Create a View

8. Touch the *New button* to create a view.
9. Either accept the generated name (New View) or touch the view's name to rename it using the on-screen keyboard (maximum length is 15 characters including spaces). Touch the *Enter* key on the on-screen keyboard after entering the new name.
10. Select the number of panels in the new or edited view from the drop-down list under the *Layout* heading. The maximum is four.
11. Choose the data to be displayed in each pane by touching a choice in the *PANEL OPTIONS* pane and then touching the appropriate panel. Repeat for each panel.
12. Touch the *Save* button to keep the changes or touch the *Cancel* button to exit the screen without saving.

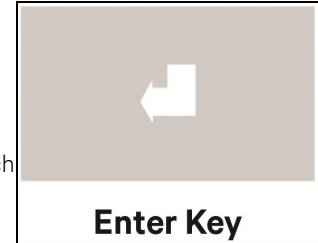
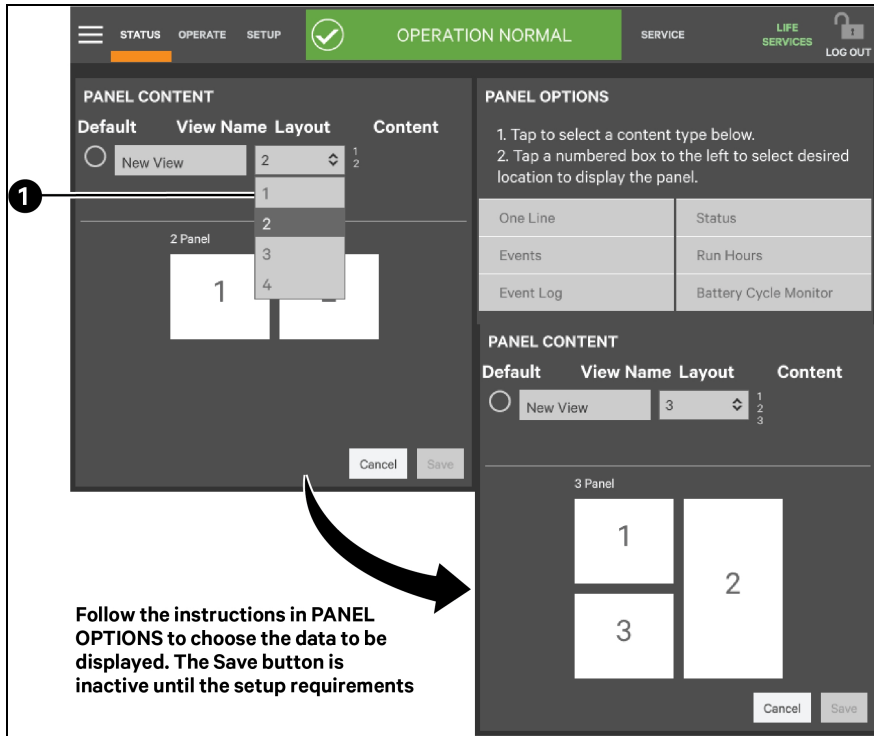

Figure 2.14 Customize the Display



ITEM	DESCRIPTION
1	Edit Button
2	Remove View Button
3	Panel shows view name, layout and content

Figure 2.15 Set Number of Panes and Choose Data



ITEM	DESCRIPTION
1	Choose the number of panels from the drop down list

13. Touch the Save button.
14. When the window returns to two screens—PANEL CONTENT and PANEL OPTIONS—touch the *Radio Button* beside the new view to activate it (this puts a dot in the circle).
15. Touch Save.
16. Touch the *STATUS* Menu icon to see the new appearance.

To choose an existing layout, navigate to the *PANEL CONTENT* screen and touch the *Radio Button* beside the layout, then touch the *STATUS Function Menu*.

2.5.1 Remove a Layout

To delete a layout:

1. Log in with Administrator or Service access.
2. From the STATUS view, touch the *Context Menu* icon in the top left corner.
3. Select *Display Options > Customize Layout*. (The right pane details how to edit or create a view; see **Figure 2.14** on page 19 .)

Edit a View

4. Touch a *View* to highlight it.
5. Touch *Remove* to delete that view.



2.5.2 Using the Edit Icon to Customize Layout

The Touchscreen Control Panel layout can also be changed with the Edit icons on the screen for a user logged-in as Operator, Administrator or Service. The Edit icon can be used to add or remove panels, resize panels, rearrange panels and change monitored parameters.

To use the Edit icon:

1. Touch the *Edit* icon on the panel to be edited and hold it until a Change content button appears on the panel (about 1 second).

Change Panel

2. Touch an icon to choose the data to be displayed in the panel (see **Figure 2.16** on the next page); choices are:

One-Line	Run Hours
Status	Event Log
Alarms	Battery Cycle Monitor Summary

Change UNIT STATUS Panel Content (see **Figure 2.16** on the next page)

3. To change the UNIT STATUS panel's content:
 - a. Touch the *Edit* icon on the *UNIT STATUS* panel and hold it until the Change content button and X's appear beside the parameters.
 - b. Touch the *X* beside the parameter to be removed from the panel.
The Add Parameter icon (+) will appear in the panel if another parameter can be added. The number of parameters that may be shown is based on whether the Status Gauge is showing.
 - c. Touching the *Add Parameter (+)* icon brings up a window to add parameters not already shown on the UNIT STATUS panel.
 - d. Touch a parameter's icon to add it to the UNIT STATUS panel.

Resize or Remove a Panel (see **Figure 2.17** on page 23)

4. Touch and hold the *Edit* icon again while the *Change content* button is displayed.
5. Release the icon. Resize handles will appear around the panel and a large X will appear at the top right corner.
6. Pull on a handle to resize the panel, or
7. Touch the large X to delete the panel.

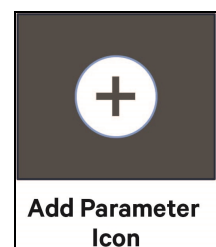

Rearrange Panels (see **Figure 2.17** on the facing page)

- 8. With the resize handles and X's visible, touch the circle in the center of the panel and drag the panel to its new position.

Exit Edit Mode

- 9. Edit Mode will deactivate after some changes. If all changes have been made and Edit Mode is active, touch the panel's header area to exit Edit Mode.

Figure 2.16 Change Panel Content

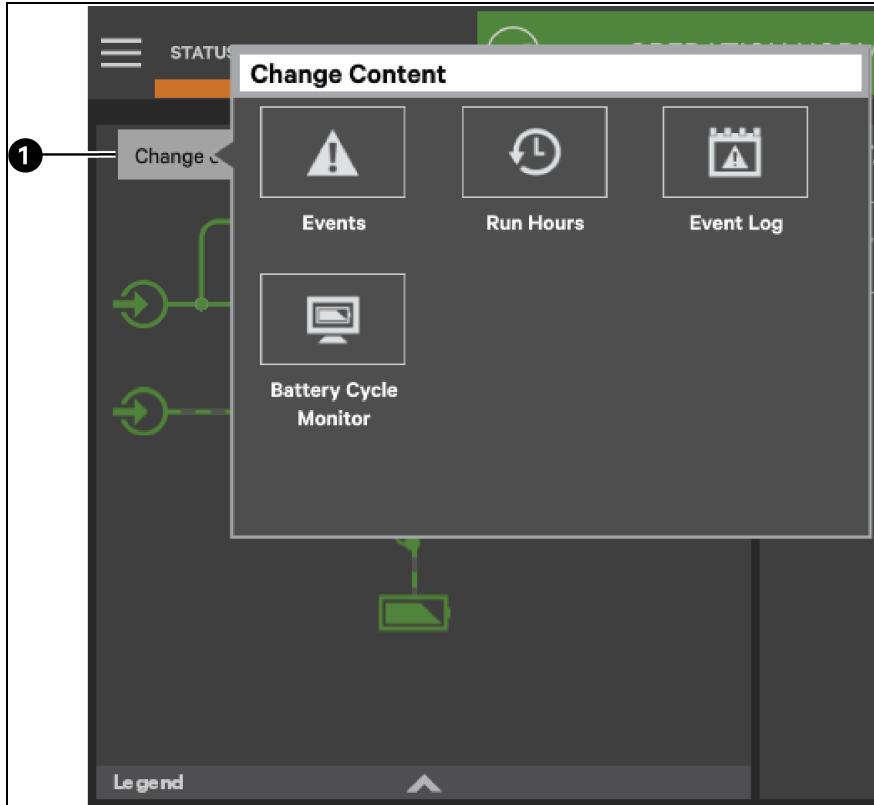

ITEM	DESCRIPTION
1	Touch the Change Content button

Figure 2.17 Resize, Remove or Rearrange a Panel

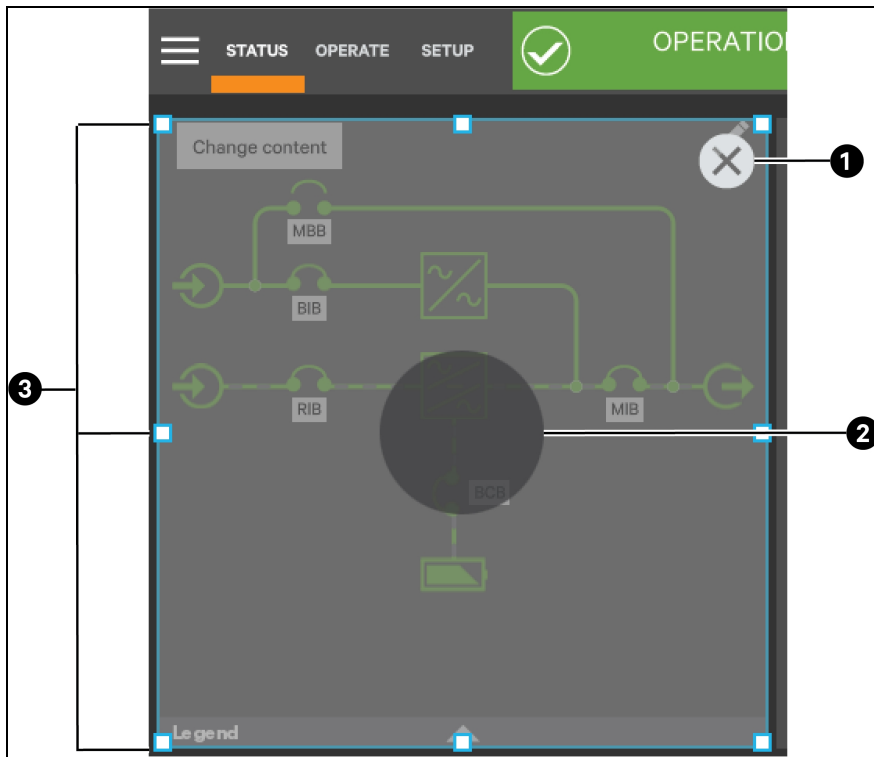

ITEM	DESCRIPTION
1	Touch X to remove the panel from the view.
2	Use this large circle to drag the panel to a new position in the view.
3	Pull a handle to resize the panel

2.5.3 Edit the UNIT STATUS Panel with the Edit Icon

The UNIT STATUS panel may be changed to add or remove data. The panel has four default parameters. Any or all can be deleted or replaced using the Edit icon.

- Possible parameters for the UNIT STATUS panel are:
- Input
- Bypass
- Battery
- Environmental
- Load

NOTE: Changes made to the UNIT STATUS panel will be applied to all views using the panel.

To edit the UNIT STATUS panel:

1. Activate *Edit Mode* by touching and holding the *Edit* icon on the UNIT STATUS panel.
2. Touch the large X beside a parameter icon to delete it or touch the + icon at the right side of the panel to add a parameter icon.
3. Touch the header area to deactivate the edit mode.

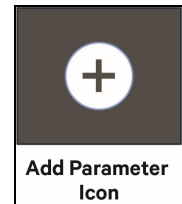
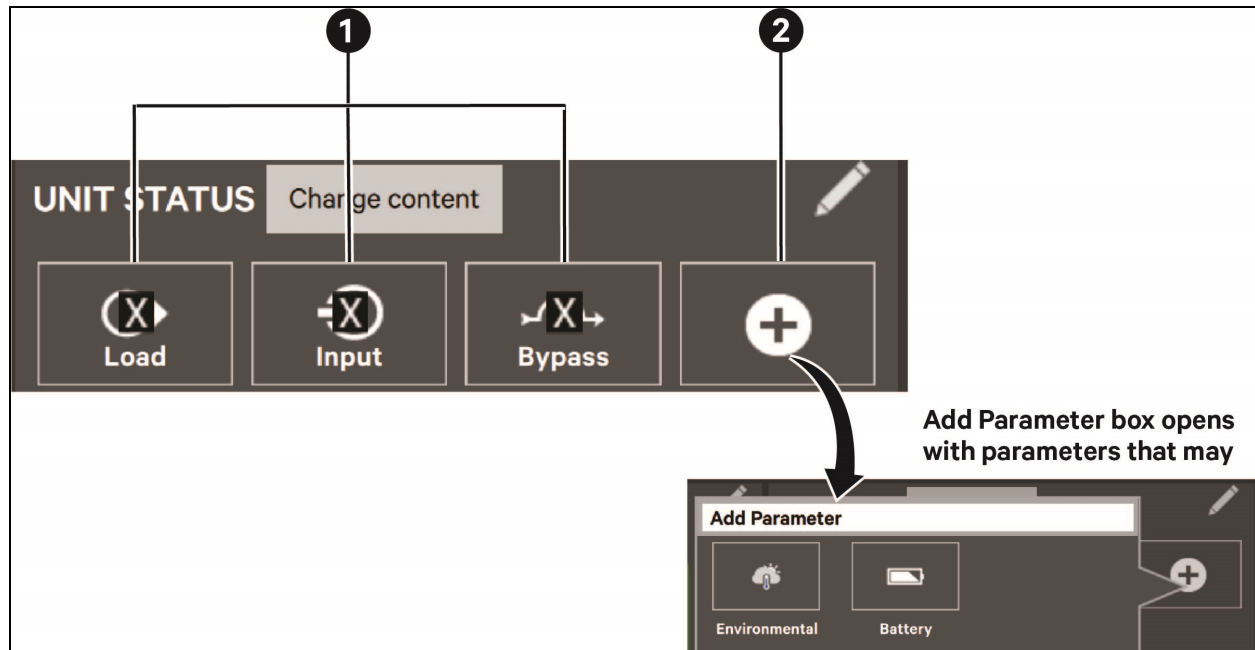

Figure 2.18 Edit UNIT STATUS Panel



ITEM	DESCRIPTION
1	Touch an X to remove the parameter from the panel
2	Touch the + icon to add a parameter to the panel; a maximum of four icons are allowed.

2.5.4 Setting DISPLAY PROPERTIES

The Context Menu for either OPERATE or SETUP permits determining how data is displayed. The DISPLAY PROPERTIES menu is available to any user, including Observers. However, the items that may be altered differs with each access level.

Table 2.1 Available Display Properties by Access Level

Display Property	Access Level			
	Observer	Operator	Administrator	Service
Language	?	?	?	?
Theme	?	?	?	?
Backlight Off Timer	X	?	?	?
Alarm Window Timeout	X	?	?	?
Auto-Logout Timer	X	X	?	?
Display Brightness	?	?	?	?
Status Indicator Brightness	X	X	?	?
Calibrate Touch Screen	X	X	?	?

Language: The default setting is English; other choices are Chinese, Spanish and Canadian French.

Theme: The default setting is Dark_Gray_9; other choices are Blue_9 and Light_Gray_9. Themes change not only the background, but also the color of some menus.

Backlight Off Timer: The default setting is Off After 5 Minutes; other choices are Off After 10 Minutes, 20 minutes, 30 minutes, 45 minutes, 60 minutes and Never.

Alarm Window Timeout: The default setting is Never. It may be changed in one-day increments from one day to 14 days.

Auto-Logout Timer: The default setting is Logout After 5 Minutes. It may be changed in one- minute increments from one minute to 5 minutes.

Display Brightness: The default setting is 80 percent, but the brightness may be changed in increments of 20 percent from the low of 20 percent to 100 percent.

Status Indicator Brightness: The default setting is 80 percent; brightness may be changed in increments of 20 percent from the low of 20 percent to 100 percent.

Calibrate Touch Screen: No default value; instructions must be followed to calibrate the touchscreen. A notification warns that performing a calibration on a properly functioning touchscreen could cause the touchscreen to fail. The notification offers a choice of going ahead with the calibration or canceling it.

2.5.5 Setting Date, Time and Time Zone

The date, time and time zone are set when the Touchscreen Control Panel is configured.

Changing the date, the time and the time zone may be done through the Context Menu on either the STATUS or SETUP page (STATUS>Display Options>Date & Time or SETUP>Display Options>Date & Time). Changing the date, time or time zone requires Administrator or Service access. These settings can be viewed, but cannot be changed, by Observers and Operators.

The format of the date or time may be changed through the Context Menu on either the STATUS or SETUP page (STATUS>Display Options>Formats or SETUP>Display Options>Formats) (refer to [Changing Date, Time and Measurement Formats](#) on page 30).

NOTE: The UTC Time is a world standard that the Touchscreen Control Panel displays. It cannot be changed.

Figure 2.19 Date and Time Settings

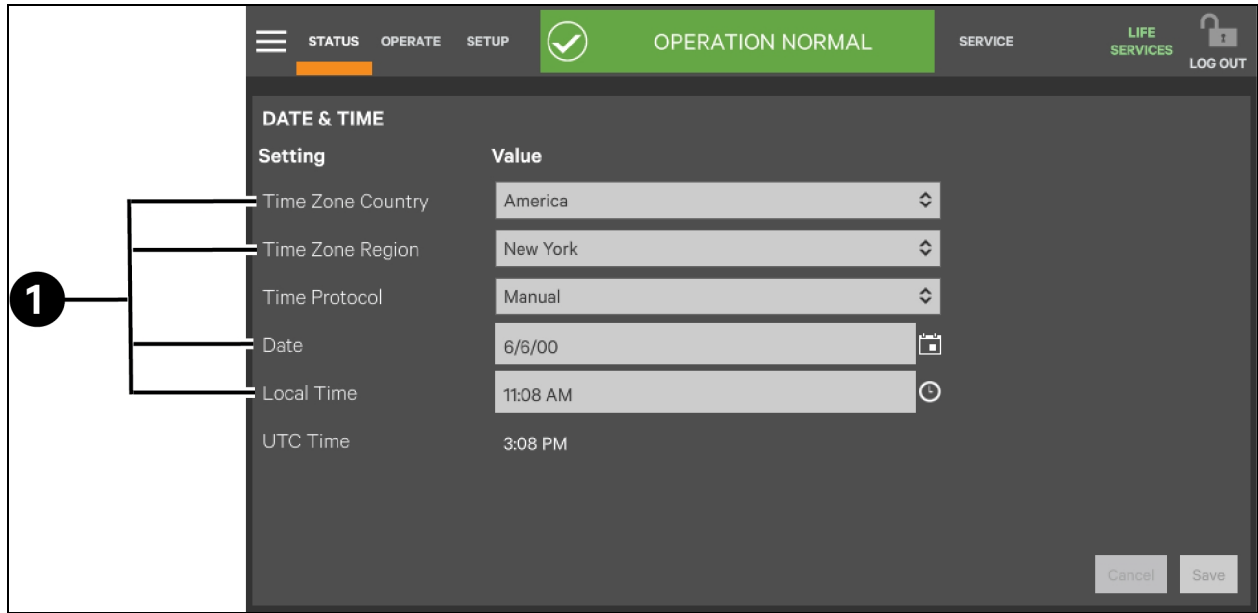

ITEM	DESCRIPTION
1	These values are entered when the Touchscreen Control Panel is configured. Changing them requires Administrator or Service access. UTC is a world standard

Changing the Time Zone

The time zone is set when the Touchscreen Control Panel is configured (the default is America/New York). The drop-down menu permits selecting any time zone on the globe, as well choosing one- hour increments before and after UTC. To change the time zone:

1. Log in with either Administrator or Service access.
2. Navigate to *STATUS>Display Options>Date & Time* or to *SETUP>Display Options>Date & Time*.
3. Touch the *Time Zone box* or either arrow on the drop-down menu.
4. Scroll to the appropriate time zone and touch it.
5. Make any other changes on the *DATE & TIME* page.
6. Touch the *Save* button to make the changes or touch *Cancel* to exit without saving the changes.

Figure 2.20 Time Zone Drop-down Menu

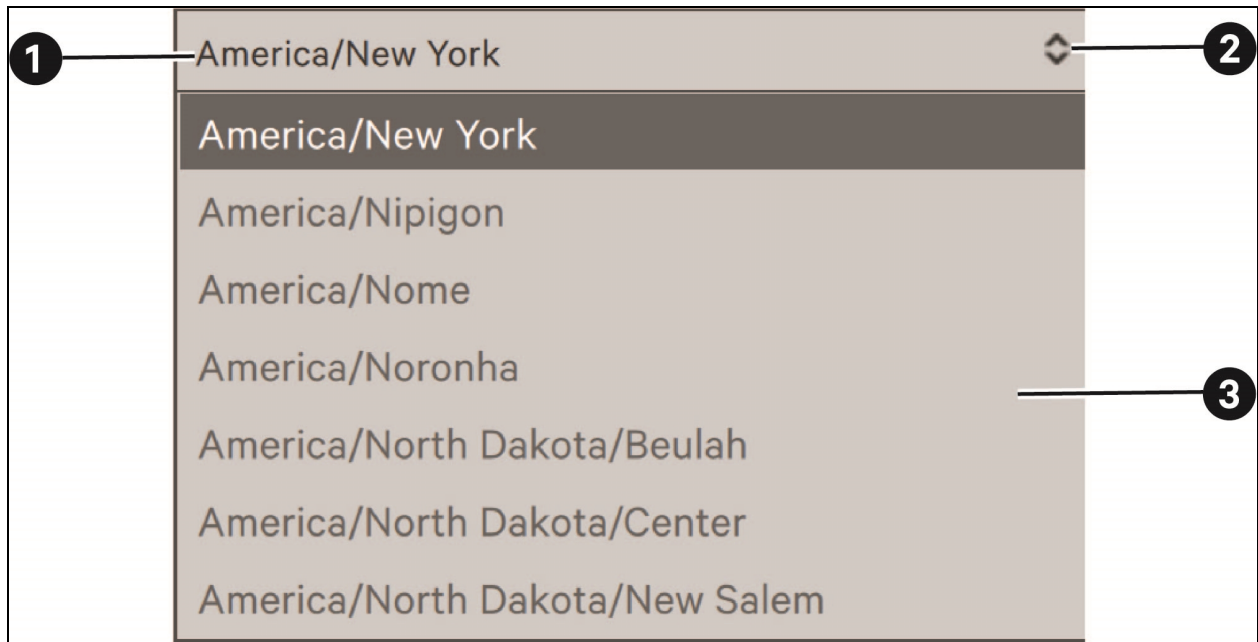

ITEM	DESCRIPTION
1	Touch the Time Zone box ...
2	or either arrow to display
3	Scroll through the list and choose the appropriate time zone

Changing the Date

The date is set when the Touchscreen Control Panel is configured. The default format is month/day/year with single numerals for months from January through September and for days 1 through 9. Changing how the date is shown requires using the Formats page found on the Context Menu on either the STATUS or SETUP menu (refer to 2.6 - Changing Date, Time and Measurement Formats).

To change the date:

1. Log in with either Administrator or Service access.
2. Navigate to *STATUS>Display Options>Date & Time* or to *SETUP>Display Options>Date & Time*.
3. Touch either the *Date box* or the *Grid* beside it. Either will display a calendar for the month.
4. Scroll to the correct month and touch the correct day.
5. Make any other changes on the *DATE & TIME* page.
6. Touch the Save button to make the changes or touch *Cancel* to exit without saving the changes.

NOTE: Touching the Graphic/Display icon permits changing the date by scrolling though months, days and years.

Figure 2.21 Change the Date

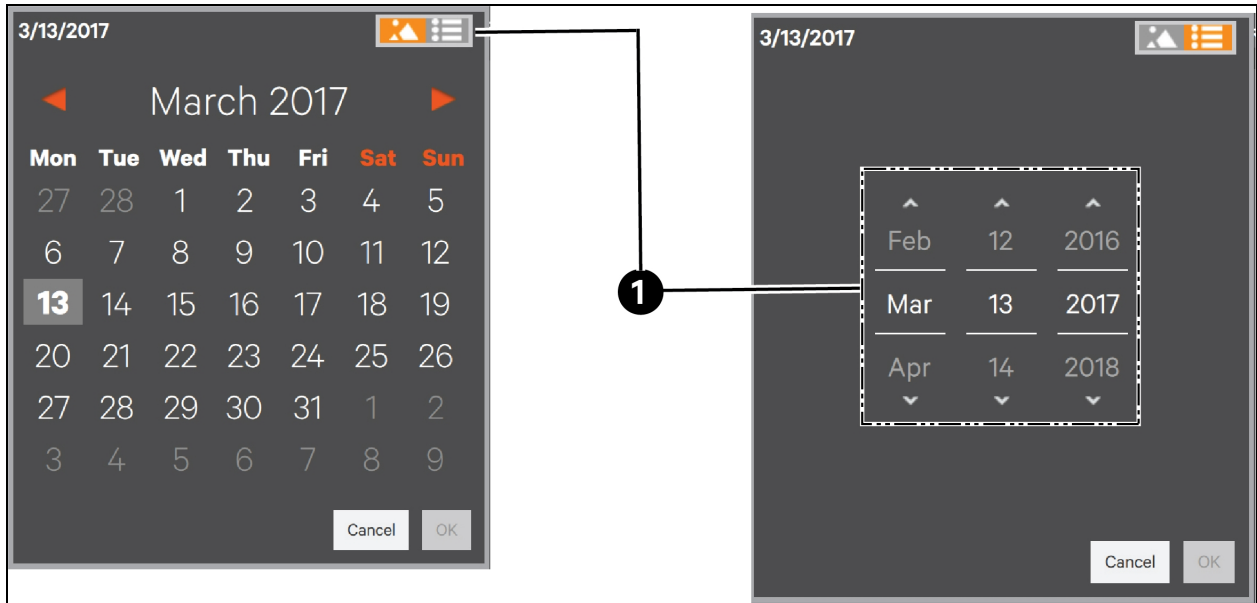

ITEM	DESCRIPTION
1	Touching this icon reveals the text date display

Changing the Time

The time is set when the Touchscreen Control Panel is configured. The default format is h:mm AP (hour:minute AM/PM) with one numeral for hours less than 10 (for example, 1:09 for nine minutes after 1 a.m. and 13:09 for nine minutes after 1 p.m.). Changing how the time is displayed requires using the Formats page found on the Context Menu of either the STATUS or the SETUP menu (refer to [Changing Date, Time and Measurement Formats](#) on page 30).

To change the time:

1. Log in with either Administrator or Service access.
2. Navigate to *STATUS>Display Options>Date & Time* or to *SETUP>Display Options>Date & Time*.
3. Touch the *Local Time* box or the *clock* icon beside it. Either will display a digital version of the time.
4. Touch the *hours*, *minutes* or *seconds* to be changed or touch the associated *Up* or *Down* arrow.

NOTE: Touching a numeral or the Up arrow and releasing it will increase the numeral by one. Touching the Down arrow and releasing it decreases the number by one.

NOTE: Holding a numeral or arrow will scroll continuously. Holding a numeral will scroll Up, increasing the numeral. Holding an arrow will scroll in the direction the arrow points.

5. When the correct time is shown, touch *OK* to save the change or touch *Cancel* to exit without saving.

NOTE: An AM/PM choice will be shown if that format is active. The AM/PM choice will not be shown for the 24-hour clock format.

6. Make any other changes on the *DATE & TIME* page.
7. Touch *OK* to save the changes or touch *Cancel* to exit without saving.

Figure 2.22 Change the Time

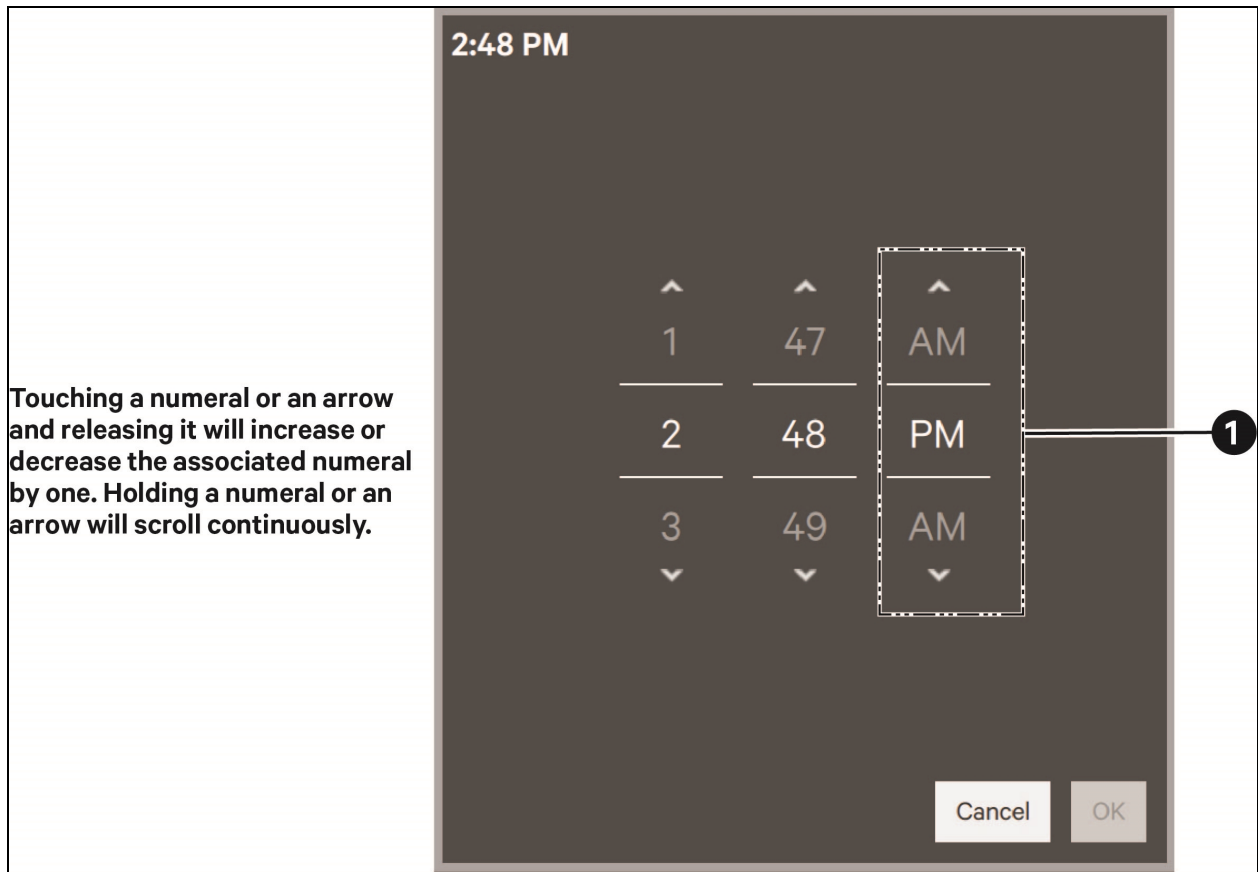

ITEM	DESCRIPTION
1	The AM/PM choice will not be shown if the 24-hour clock format is active.

2.6 Changing Date, Time and Measurement Formats

The Touchscreen Control Panel has these default settings:

- **Date:** M/d/yyyy
- **Time:** h:mm (either AM/PM or am/pm)
- **Measurement System:** Metric

These formats may be changed by any user, including an Observer, by going to Status>Display Options>Formats; choose the format or measurement system and touch Save.

2.6.1 Change the Date Format

To change the way the date is displayed, touch inside the box containing the date format and choose the format from the choices shown in **Figure 2.23** below .

2.6.2 Change the Time Format

To change the way the time is displayed, touch inside the box containing the time format and choose the format from the choices shown in **Figure 2.23** below .

2.6.3 Change the Measurement System

To change the way measured values, such as heat, kW and voltage, are displayed, touch inside the box containing the Measurement System and choose either Imperial or Metric as shown in **Figure 2.23** below .

Figure 2.23 Date/Time Format and Measurement System Choices

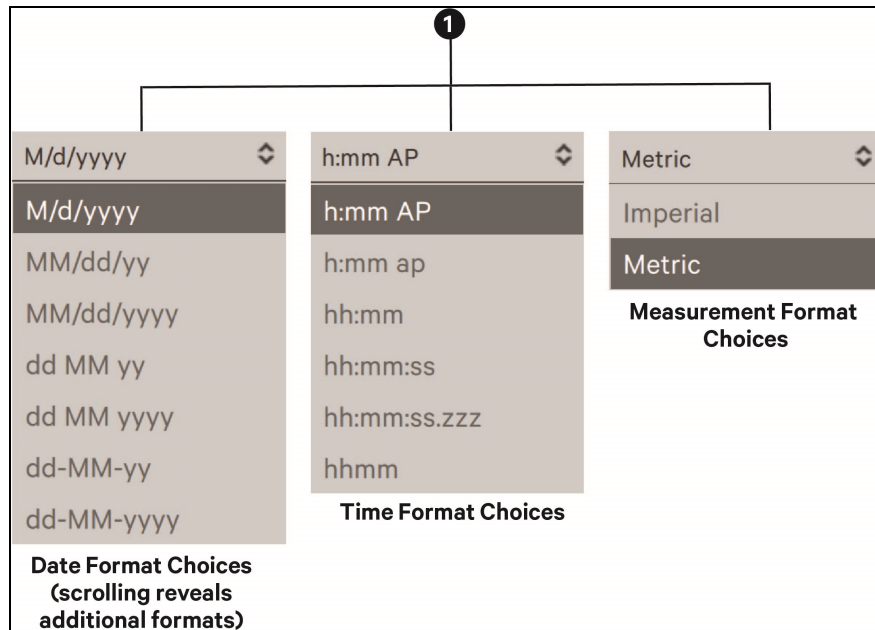

ITEM	DESCRIPTION
1	Touch inside this box to change the format.

2.7 Create or Modify Custom Labels

The CUSTOM LABELS page permits renaming settings, serial ports and network interfaces. New names may be entered for these to suit local preferences and to ease troubleshooting and refine data. (The default name of COM1 may be adequate, but renaming it with the connected device may ease determining the cause of an alarm).

Custom labels may be created or modified by any user, including Observers. The labels are universal and will be displayed for all users.

To create or modify a custom label:

1. Go to *STATUS>Display Options>Custom Labels*.
2. Choose the label group to change.

NOTE: Changing a particular Setting may require scrolling (see Figure 2.24 below and Table 2.2 on the next page.)

3. Touch inside the *Custom Label* box beside the setting to be labeled.
4. Use the on-screen keyboard to enter the label name.
5. Touch the *Enter* key.
6. Touch *Save* to make the change or touch *Cancel* to exit without saving.

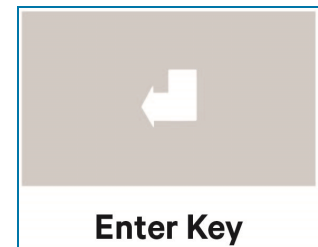
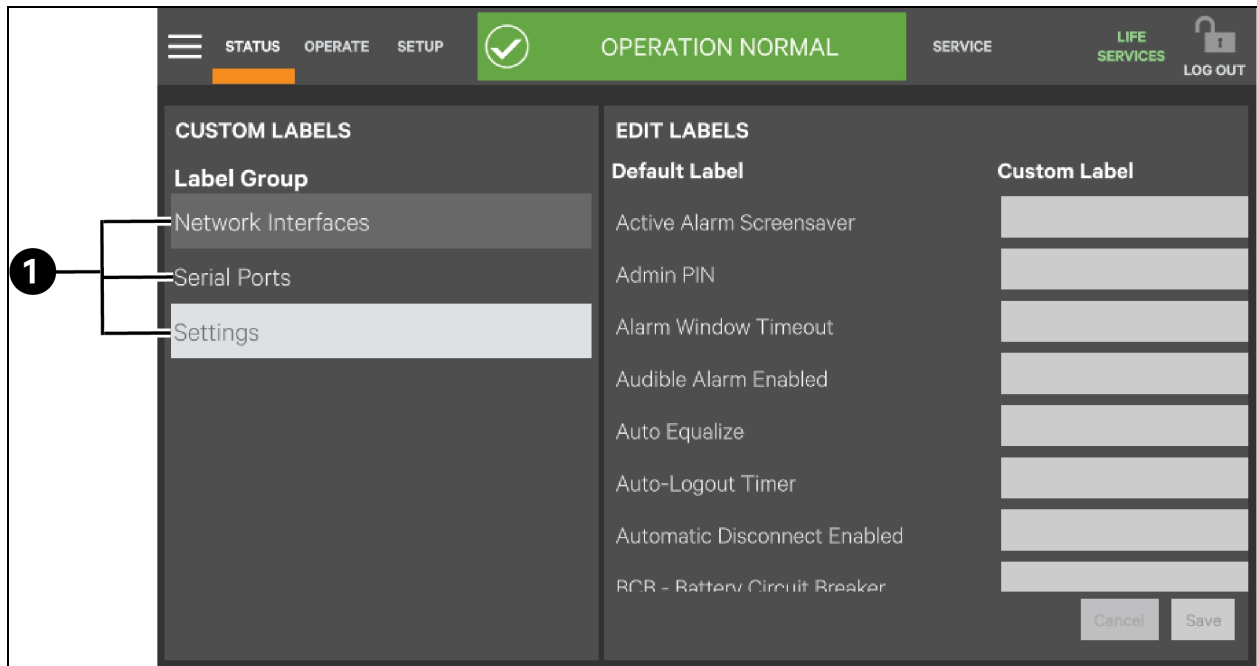

Figure 2.24 Custom Labels Page



ITEM	DESCRIPTION
1	Touch any of these headings to create custom label.

Table 2.2 Additional Custom Label Choices for Settings

Backlight Off Timer	Battery Type	Bypass
Bypass Kva Rating	CB1 - Rectifier input breaker	CB2 - Inverter output breaker
CB3-Internal bypass breaker	Cell Number	Check TS Calibration
Country	DNS Server	Date
Date Format	Disconnect Temperature Limit	Display Brightness
Display Touch Beep	Energy Savings Configuration	Equalize Charge Duration
Equalize Charge Voltage	Font Name	Font Size
Getting Started Visible	IOB-Inverter output breaker	Inactivity Timer
Kva Per Module	Kva Rating	LBB-Load bank breaker
Language	Local Contact	Local Life Contact
Local Life Service Name	Local Service Name	Local Time
Location Id	MBB-Maintenance bypass breaker	MBD-Module battery disconnect
MIB-Maintenance isolation breaker	MOB-Module Output Breaker	Manufacturer
Measurement System	Minimum Cell Voltage	Model
Model Number	Model Type	Module Number
Module Redundancy	Monitoring Contact	Network Time Protocol
Nominal Cell Voltage	Nominal Frequency	Nominal Voltage
Operator PIN	Popup Test	Q12-Input transformer isolator
Q21-Bypass transformer isolator	Q22-Bypass isolator	Q33-Static switch disconnect switch
QBP-Maintenance bypass isolator	QEN-Output isolator	QOP-Output isolation switch
QS1-Input isolator	QS2-Bypass isolator	QS3-Maintenance bypass isolator
QS4-Output isolator	QS90-Battery isolation switch	RFB-Rectifier feed breaker
RIB-Rectifier input breaker	Runtime Remaining	SBB-System bypass breaker
SW1-Static switch disconnect switch	Screen Resolution	Serial Number
Serial Protocol	Service PIN	Single Input
Status Indicator Brightness	System Identification	Tag Number
Test Cycle	Test Day of Week	Test Duration Time
Test Duration Type	Test Time of Day	Test To Remaining Capacity
Theme	Time Format	Time Zone
UIB-UPS input breaker	UOB-UPS system output breaker	UTC Time
Unit Name	Unit Version	Warning Temperature Limit
Warning Type	WebSite Contact	—

Figure 2.25 Custom Labels for Serial Ports and Network Interfaces



This page intentionally left blank

3 Operation

3.1 Log In to the Touchscreen Control Panel

The Touchscreen Control Panel is On whenever the UPS has control power. It may be inactive and appear dark, depending on its settings. If it is inactive, touch the LCD to activate it.

To log in to the Touchscreen Control Panel:

1. Touch the *LOG IN* icon at the top right of the screen.
The lock and background will change color and open the *PIN REQUIRED* screen, which has a keypad.
2. Enter a *PIN* at the screen below.
3. Touch *Enter*.

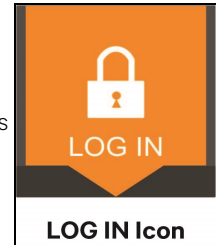

NOTE: Entering an incorrect PIN will generate a screen saying the number is invalid.

Figure 3.1 Log in Screen

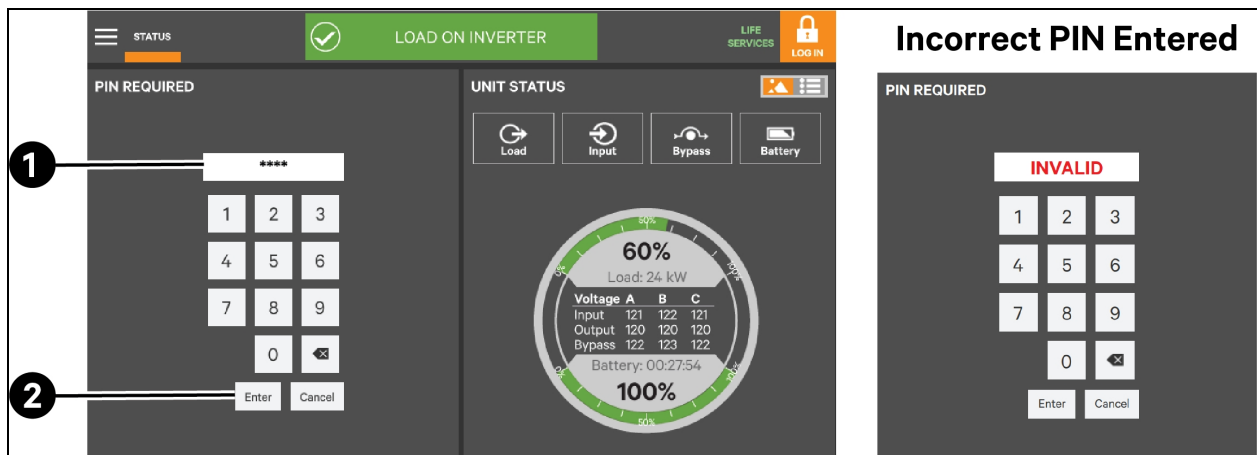

ITEM	DESCRIPTION
1	Use the keypad to enter the four numbers in the PIN.
2	Touch Enter

3.2 Operator Controls

The Operator login confers control of UPS functions:

- Silence (Alarm)
- Inverter On
- Inverter Off
- Reset Fault
- Energy Saving Mode Activation
- Battery Operations

Each command is available under the OPERATE menu. The OPERATE menu may be used by logging in with Operator, Administrator or Service access.

NOTICE

Risk of improper operation. Can cause load drop, resulting in equipment damage.

The Inverter On, Inverter Off, Reset Fault and Energy Saving Mode Activation commands will be available whenever the UPS is operating. Before executing any command, verify that the UPS status and the connected load status are suitable for the command to be performed.

3.2.1 LIFE™ Services

The OPERATE Context Menu also permits enabling and setting up LIFE Services. This may be done only with assistance from the LIFE Support group, reachable by the telephone number on the dialog that opens at STATUS>LIFE Services>Support or by touching the LIFE Services icon (see [LIFE™ Services—Context Menu and LIFE Services Function Menu](#) on page 45).

3.3 OPERATE Menu Commands

All Operator commands are available from the OPERATE menu whenever the UPS has input power. It may be accessed by logging in with Operator, Administrator or Service access. The UPS need not be supplying power to the load for the menu to be available.

The Touchscreen Control Panel shows the screen in **Figure 3.2** below when the OPERATE Function Menu is active. The animated mimic moves to the right side of the screen; it is not linked to data in this view, so touching a component will not cause it to display data. The animated mimic will display the power path in this view.

Figure 3.2 Operate Function Menu Screen

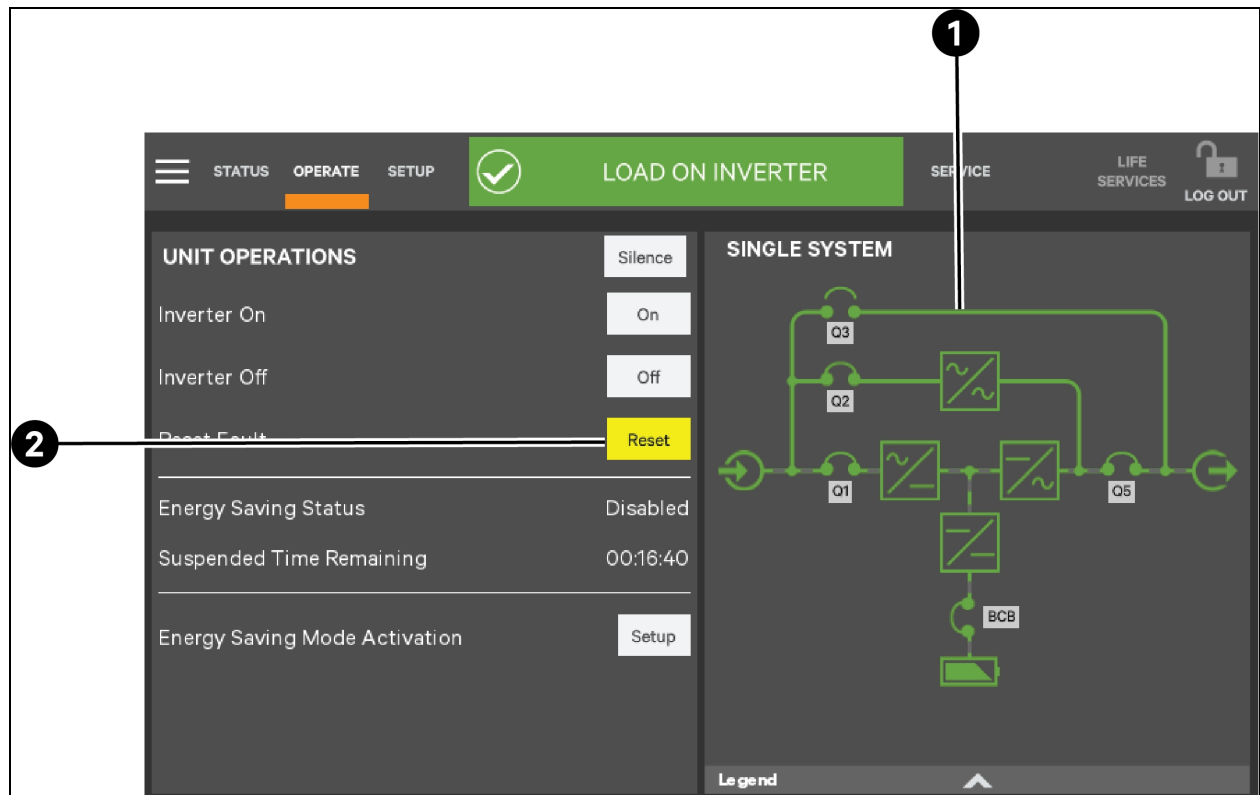

ITEM	DESCRIPTION
1	Animated mimic is not linked to data in this view.
2	Reset Fault Button

Commands in the OPERATE Function Menu are the same for all access levels that can view it.

3.3.1 Silence an Alarm

To silence an alarm, touch the Silence button at the top of the panel. The time the alarm will remain silenced depend on the UPS model, type of alarm and system configuration.

This command is also available at *STATUS>Alarms*. That screen permits silencing one or more alarm, acknowledging an alarm and viewing either all alarms or just active alarms.

3.3.2 Inverter On

The Inverter On menu item is available whenever the UPS has input power and the inverter is Off. Before executing the command, verify that the UPS is prepared for the inverter to start.

If the UPS is part of a multi-module system, the Touchscreen Control Panel will display a message asking whether the command will affect a single UPS or the entire system. The message asks for confirmation to start the inverter and notes that it may take a moment to start (see **Figure 3.3** below).

The control will display a progress window while the inverter starts.

Figure 3.3 Inverter On Command

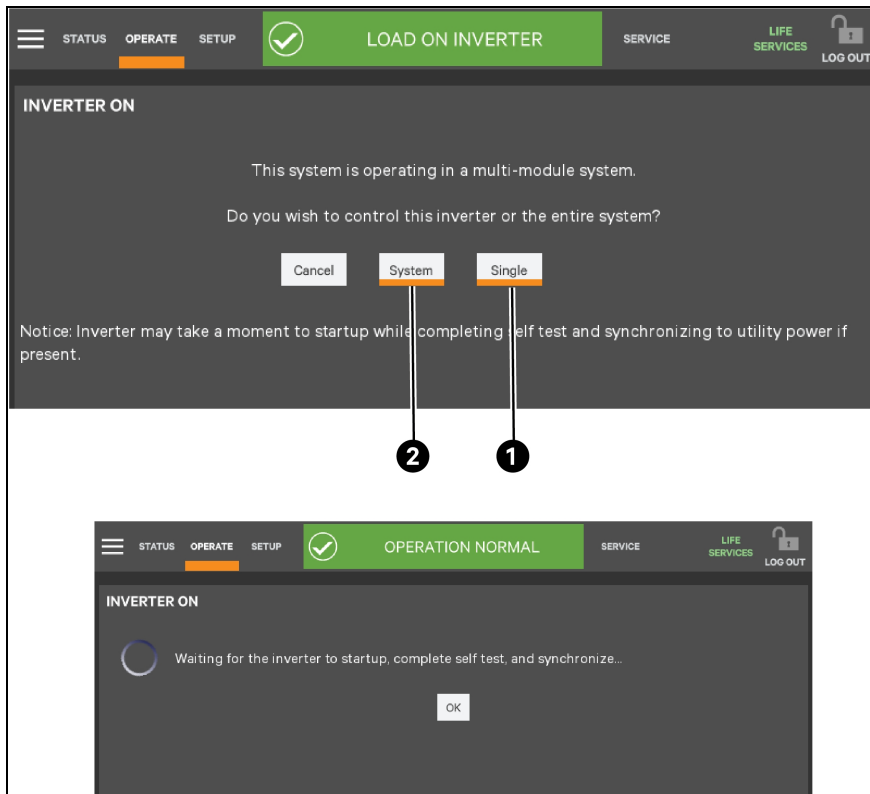

ITEM	DESCRIPTION
1	Press the Single button to start the inverter in just this UPS.
2	Press the System button to start all inverters in the entire system.

3.3.3 Inverter Off

The Inverter Off menu item is available whenever the UPS has input power and the inverter is On. Before executing the command, verify that the UPS and connected load are prepared for the inverter to be shut down. The LCD will display different messages depending on whether the UPS is operating as a single unit or as part of a multi-module system (see **Figure 3.4** below).

NOTICE

Risk of improper operation. Can cause load drop resulting in equipment damage.

The Inverter Off command will shut Off power to the connected load unless bypass power is available. Before executing this command, verify that the connected load is either shut Off or that input power to the load will be supplied by another source, such as bypass.

Figure 3.4 Inverter Off Command

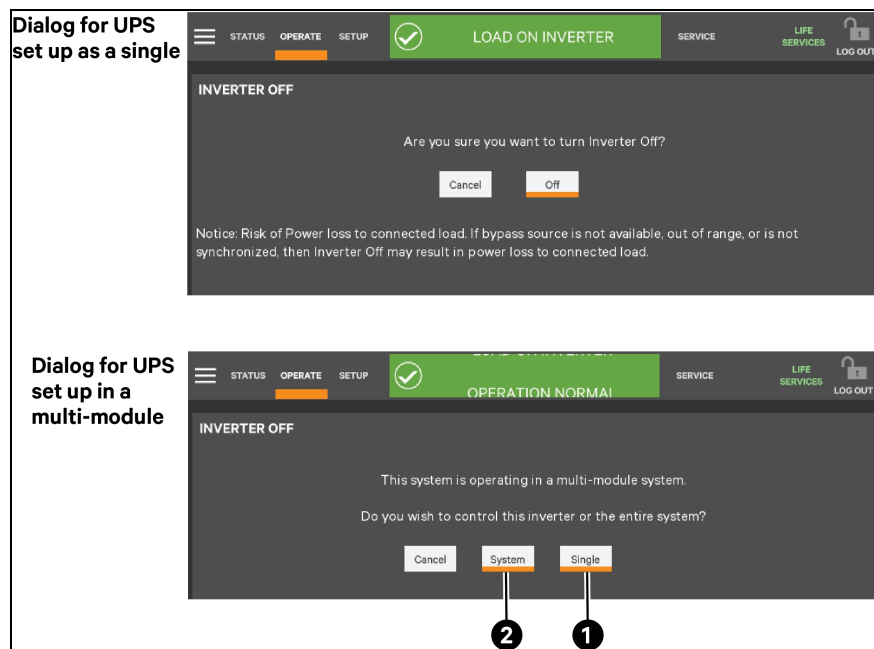

ITEM	DESCRIPTION
1	Press the Single button to shut Off the inverter in just this UPS.
2	Press the System button to shut Off all inverters in the entire system.

3.3.4 Reset Fault

Faults may be reset with the Reset button (see **Figure 3.2** on page 36 for the button's location).

Figure 3.5 Reset Fault Command

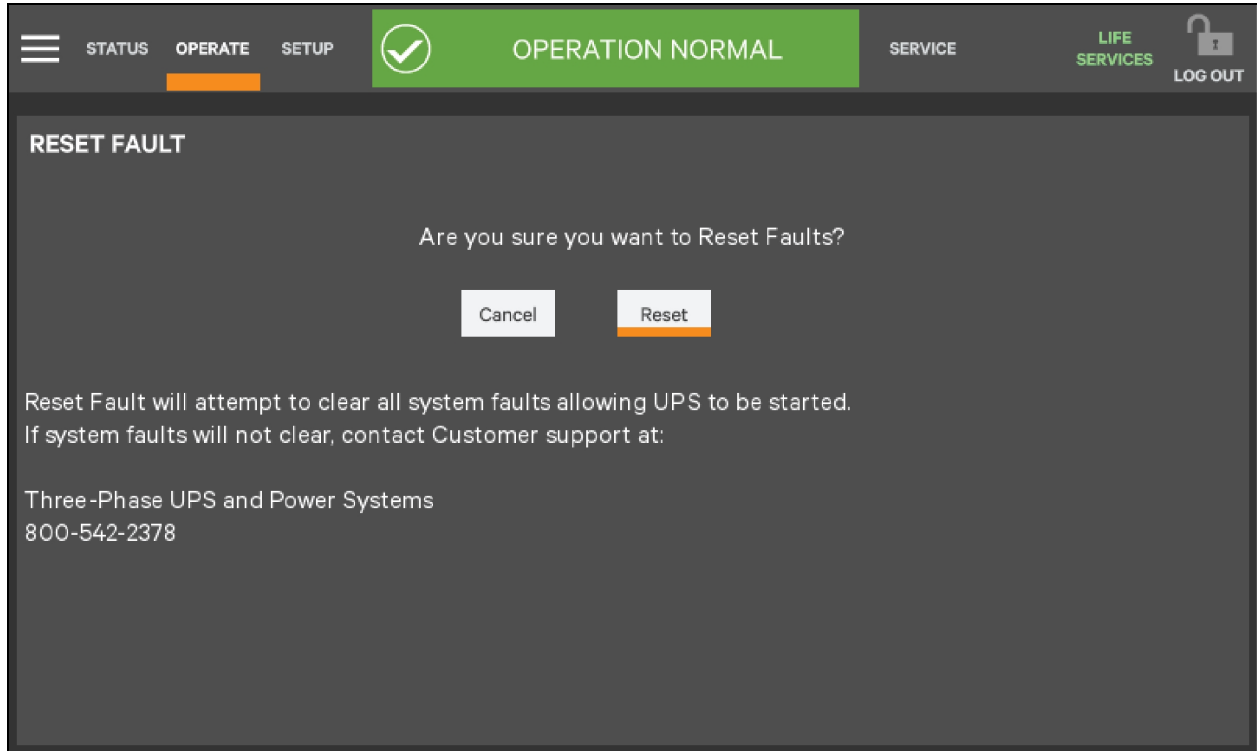

3.3.5 Suspended Time Remaining

The Suspended Time Remaining is not configurable. The reading shows the time remaining when Energy Saving Mode is suspended. It becomes active when Energy Saving Mode has alternated between active and inactive too frequently and the system has suspended its activation for a period. The UPS will enter Energy Saving Mode when the feature is enabled and input power meets qualifications. If input power degrades, the UPS will exit Energy Saving Mode.

3.3.6 Module Redundancy Status

Module redundancy is usually chosen during system setup. Redundancy may be enabled only with Administrator or Service permission. Proper operation requires the presence of at least a second module, but a system may encompass more modules.

To enable module redundancy:

1. Log in with Administrator or Service permission.
2. Touch the *SETUP Function Menu*.
3. Touch the *Context Menu* icon and select *Settings*.
4. Select *Unit*.
5. In the Module Redundancy drop-down menu, touch *Yes*.
6. Touch *Save* to save the new setting or touch *Cancel* to exit without saving.

Figure 3.6 Enable Module Redundancy

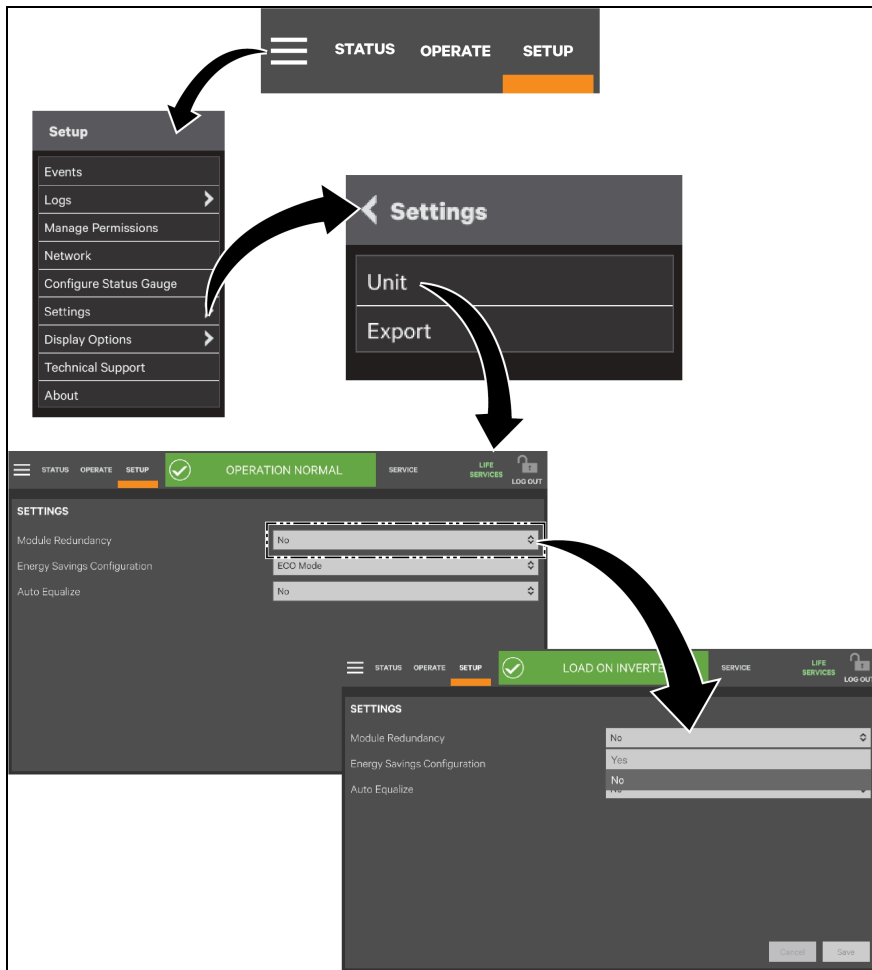

3.3.7 Energy Saving Mode Activation

NOTE: Refer to the UPS manual before activating Energy Saving Mode. An Operator can only enable or disable Energy Saving Mode. The modes available vary according to the UPS type and system configuration. The types available must be set up by someone with either Administrator or Service access (see [Module Redundancy Status](#) on page 40).

Energy Saving Mode may be activated or deactivated through the OPERATE menu screen. Two modes are available: Eco Mode and Intelligent Parallel Mode.

Eco Mode permits the UPS to reduce power consumption by powering the load through bypass power when utility-supplied power is within acceptable ranges. The inverter will remain in a state that will permit it to resume supplying power if the utility power goes outside acceptable ranges.

Intelligent paralleling puts units in Sleep Mode until required to support the load.

To activate or deactivate Energy Saving Mode:

1. Touch the *SETUP* Function Menu.
2. Touch the *Context* Menu and select *UPS Settings*.
3. Choose the type of energy saving option, *Intelligent Parallel* or *ECO Mode*.

If Intelligent Parallel is chosen:

4. Enable Module Redundancy.
 - a. Touch the *OPERATE* Function Menu.
 - b. Touch the *Save* button for Energy Saving Mode Activation.
 - c. Touch *Enable* to permit an energy saving function to operate.
5. Touch the *Save* button to make the change or touch the *Cancel* button to exit without saving.
The *Save* button is inactive until the activation state is changed.

Figure 3.7 Activating Energy Saving Mode

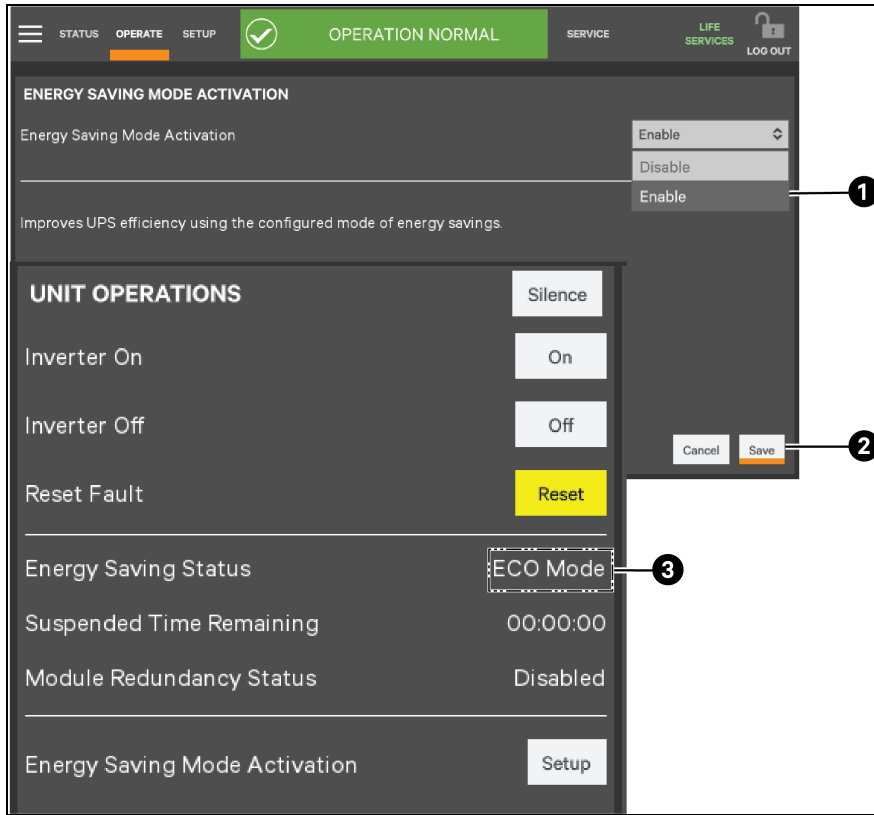

ITEM	DESCRIPTION
1	Choose Enable from the drop-down list to activate Energy Saving Mode.
2	The Save button becomes active when the status is changed.
3	Enabling Eco Mode or another energy saving mode changes the Energy Saving Status on the OPERATE menu.

3.4 Audible Alarm Enabled or Disabled

The Touchscreen Control Panel permits enabling an audible alarm to alert personnel to problems with the power supply to the connected load. Enabling or disabling the audible alarm requires Administrator or Service access.

To enable or disable the audible alarm:

1. Touch the *STATUS* Function Menu
2. Touch the *Context Menu* and select *Display Option*.
3. Select *Display Properties*.
4. *Enable* or *Disable* the Audible Alarm by touching the lighter associated box.

Figure 3.8 Audible Alarm

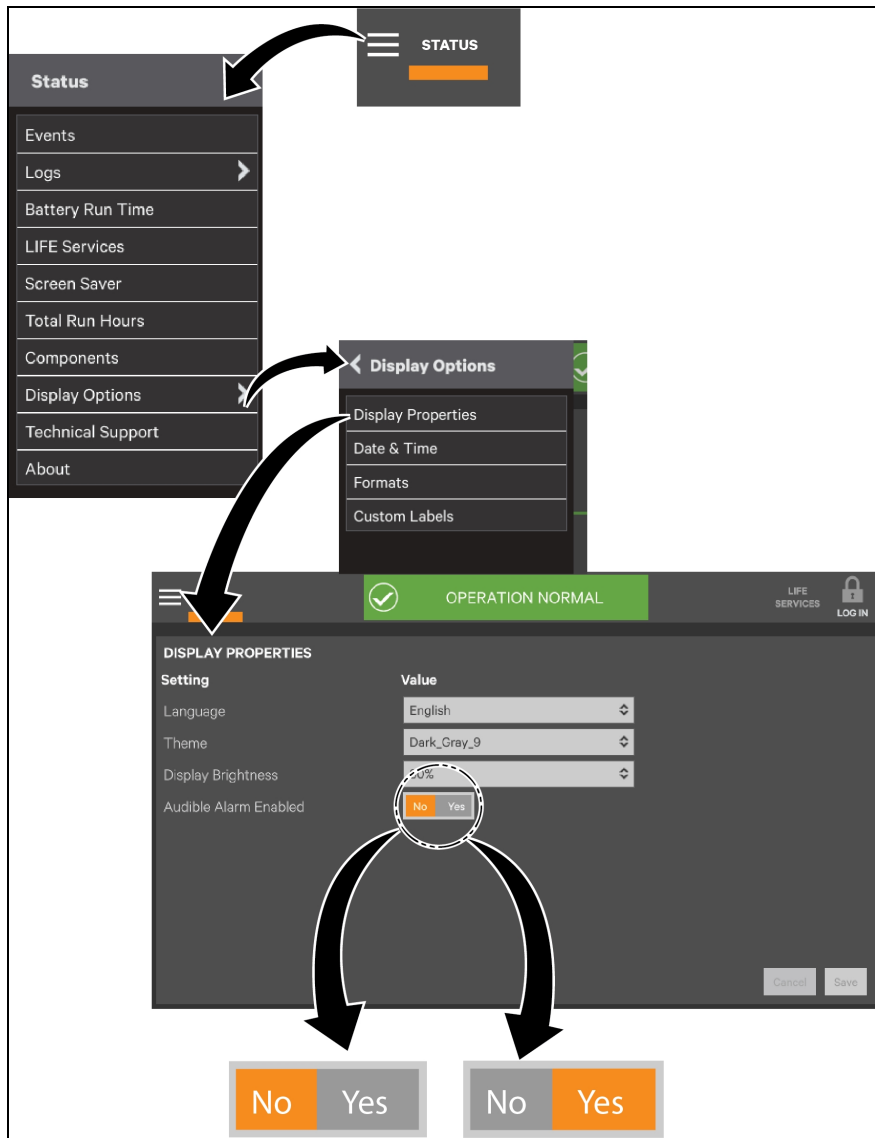

3.5 LIFE™ Services—Context Menu and LIFE Services Function Menu

The Context Menu on the OPERATE Function Menu permits setting up and configuring LIFE Services, if the required maintenance contract is obtained. LIFE Services provides increased up- time and operational efficiency through continuous monitoring, expert analysis and proactive response. Detailed parametric data is continuously captured with advanced technology embedded in select critical systems. The data is transmitted to an authorized remote service center staffed with system engineers. Should an operating anomaly or alarm condition arise, the engineer analyzes the information and initiates an appropriate response to have the critical system quickly, safely, and accurately restored to its proper operating condition.

To initialize LIFE Services:

1. Log in with Operator, Administrator or Service access.
2. Touch the *LIFE Services* Function Menu.
3. Telephone the number on the screen and follow the instructions given.

To configure LIFE Services:

1. Log in with Operator, Administrator or Service access.
2. Touch the *OPERATE* Context Menu and select *LIFE Services*.
3. Select the appropriate menu item: *Status*, *Support* or *Actions*.
 - Status shows whether *LIFE Services* is enabled and gives details about calls and connections.
 - Support shows telephone numbers to contact LIFE Support.
 - Actions permits configuring LIFE Services.

Figure 3.9 LIFE Services—Menus

STATUS		ACTIONS	
Status	Normal	Set Service/Maintenance Mode	Set
Operating Mode	Sampling	Initiate Manual Call	Start
Current Date/Time	3/16/2017 9:04 AM	Reset Delayed Call	Reset
Last Call		Clean LIFE Data Buffer	Clean
Next Scheduled Call		Set First Call Date	3/16/2017
Delay Counter	0	Call End Time	9:00 AM
Call Interval	0	Set Scheduled Call Interval	0
Connection Status	Not Connected		
Call Type	Undefined		
		SUPPORT	
		Life Support	
		800-542-2378	
		Outside North America: 614-841-6598	

This page intentionally left blank

4 Viewing UPS Status

The Touchscreen Control Panel interface reports UPS status in multiple ways. The graphic views and text views will show the same information, but display it differently.

Alarms and certain events will trigger audible alarms and the LED on the bezel, the light bar and the status header will change color. (Audible alarms will not sound unless enabled.) The scrolling information bar at the top of the interface summarizes information about the UPS status. The Status Gauge on the UNIT STATUS pane gives additional details about the UPS status.

4.1 Viewing UPS Data with the Status Gauge

The Status Gauge offers a quick summary of the UPS's status. The information shown depends on the type of UPS and its configuration and upon the choices made in the gauge's setup. The data can be chosen by someone with Administrator or Service access.

The additional data will not replace the information shown in the center of the Status Gauge. Touching the center of the Status Gauge multiple times will cycle through the data.

Figure 4.1 Default Status Gauge View

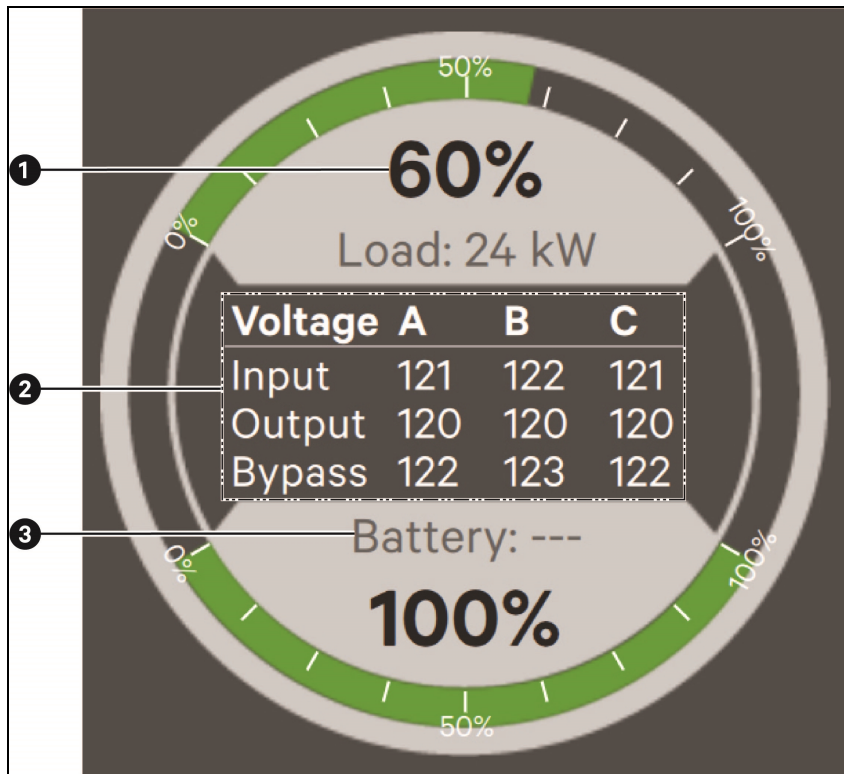

ITEM	DESCRIPTION
1	Load as a percentage of UPS capacity and in output supplied (also shown in green graph)
2	Voltage status for each phase, input, output and bypass
3	Battery charge level (also shown in green graph line)

To change the values shown on the Status Gauge:

1. Log in with either Administrator or Service access.
2. Touch the *SETUP* Function Menu icon.
3. Touch the *Context* Menu icon.
4. Touch *Configure Status Gauge*. This opens the DIAL CONTROL SETUP panel, which holds settings for the readings in the center of the gauge and for the upper and lower metering.

To change the data shown in the center of the gauge:

- a. Expand the Center Readings menu by touching the arrow beside it.
- b. Put a check mark (?) in the check box beside each value to be displayed (see **Figure 4.2** below and **Figure 4.3** on the facing page).

NOTE: All possible values may be checked. Touching the center of the gauge multiple times will cycle through the values.

To change the data shown in the gauge’s upper or lower section:

- a. Expand the *Upper Meter* or *Lower Meter* menu by touching the arrow beside it.
 - b. Use the drop-down menu to choose whether the Upper Meter or Lower Meter shows data for the Battery or Load. (Either the upper or lower part of the Status Gauge may be used to show Load or Battery readings.)
 - c. Use the sliders to change the Warning Threshold or Critical Threshold (see **Figure 4.2** below and **Figure 4.3** on the facing page).
5. Touch the *Save* button to keep the changes or touch *Cancel* to exit without saving the changes.

NOTE: The DIAL CONTROL SETUP pane may be also be accessed by touching the Status Gauge and holding it for about 2 seconds. This requires Administrator or Service access.

Figure 4.2 Access Status Gauge Settings

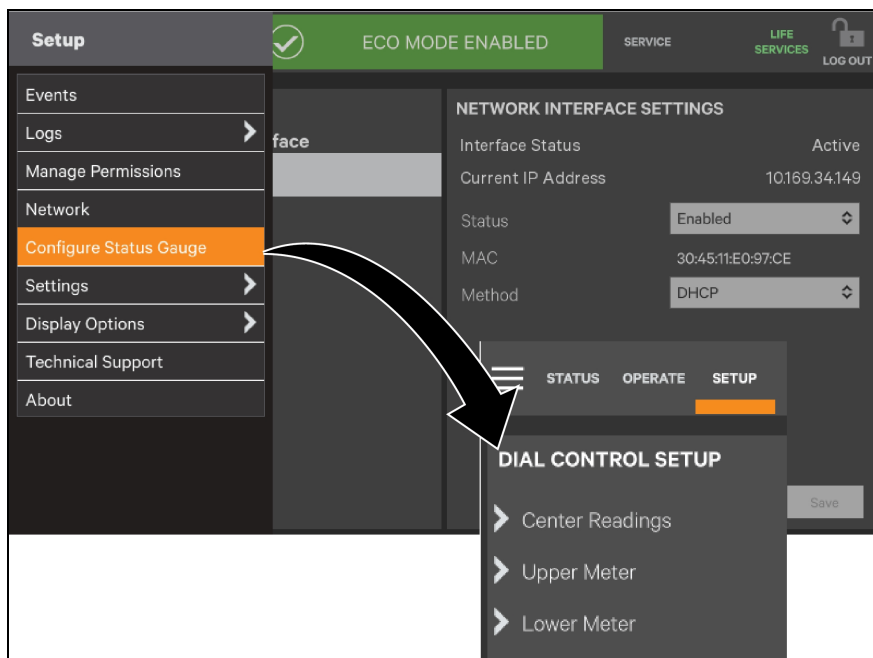
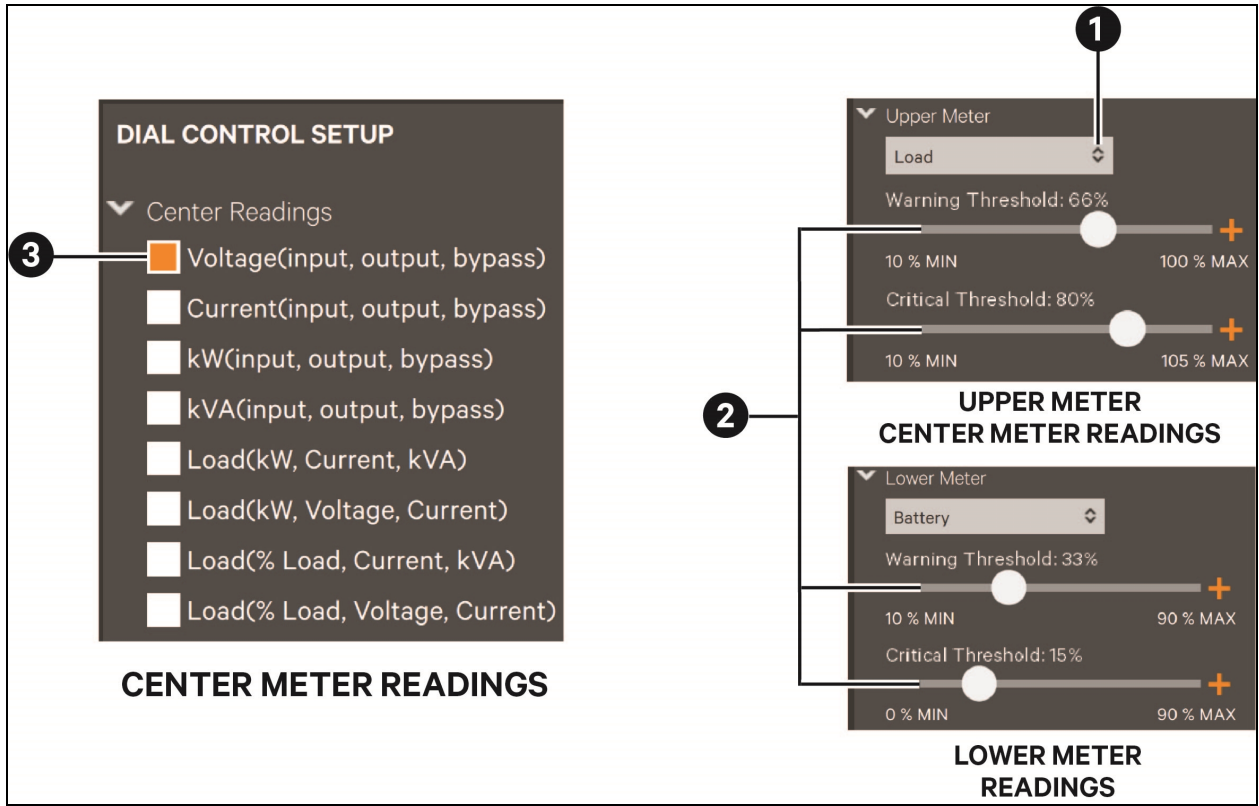

Figure 4.3 Status Gauge Settings Options



ITEM	DESCRIPTION
1	This drop-down menu permits putting the Load or Battery readings in the upper or lower portion of the meter
2	Use the sliders to change the warning thresholds
3	Put a check mark (?) in the box for each value desired.

4.2 Viewing UPS Data with the Status Panel

More-detailed information about the UPS's status is readily available through the UNIT STATUS pane. Touching a component in the animated mimic display brings up data about that component on another pane. Touching a parameter icon on the UNIT STATUS pane brings up further details about that parameter.

The same data can be viewed by switching to the text view. The length of the lists and order of the details may require scrolling to see the desired data.

NOTE: A parameter must be visible on the UNIT STATUS screen for details to be viewed. For instance, if the UNIT STATUS pane does not show the Environmental icon, details about Environmental cannot be viewed.

Figure 4.4 UNIT STATUS—Load Details

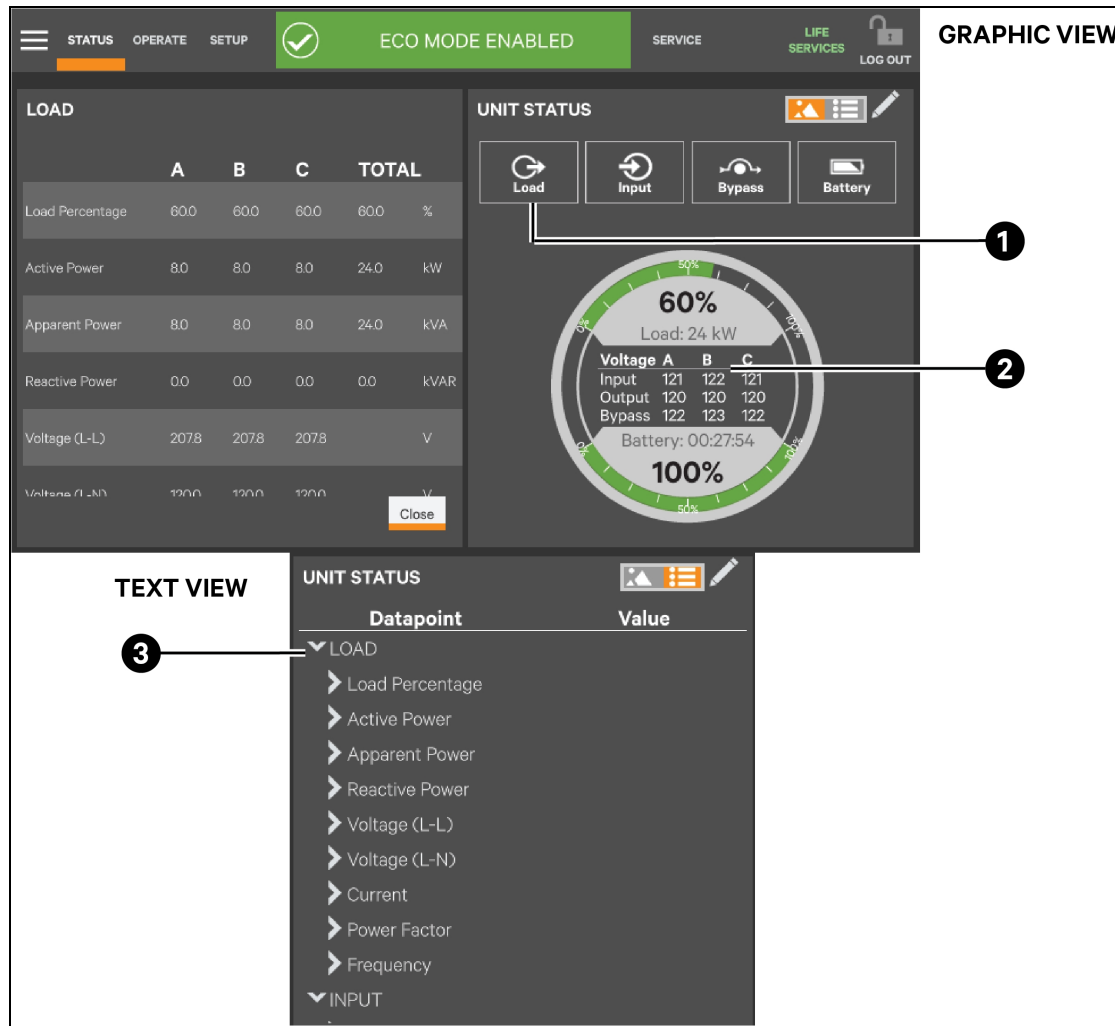

ITEM	DESCRIPTION
1	Touch the Load icon to reveal the information at left.
2	Some data in the columns at left is summarized in the Status.
3	Data in the columns in the graphic view is visible in the text view by expanding the parameter. Here, LOAD has been expanded.

Table 4.1 LOAD Menus

Load Percentage	Active Power	Apparent Power	Reactive Power
Load Percentage A	Active Power A	Apparent Power A	Reactive Power A
Load Percentage B	Active Power B	Apparent Power B	Reactive Power B
Load Percentage C	Active Power C	Apparent Power C	Reactive Power C
Load Percentage Total	Active Power Total	Apparent Power Total	Reactive Power Total
Voltage (L-L)	Voltage (L-N)	Current	Power Factor
Voltage (A-B)	Voltage (A-N)	Current A	Power Factor A
Voltage (B-C)	Voltage (B-N)	Current B	Power Factor B
Voltage (C-A)	Voltage (C-N)	Current C	Power Factor C
Frequency			
Frequency A			
Frequency B			
Frequency C			

Figure 4.5 UNIT STATUS—Input Details

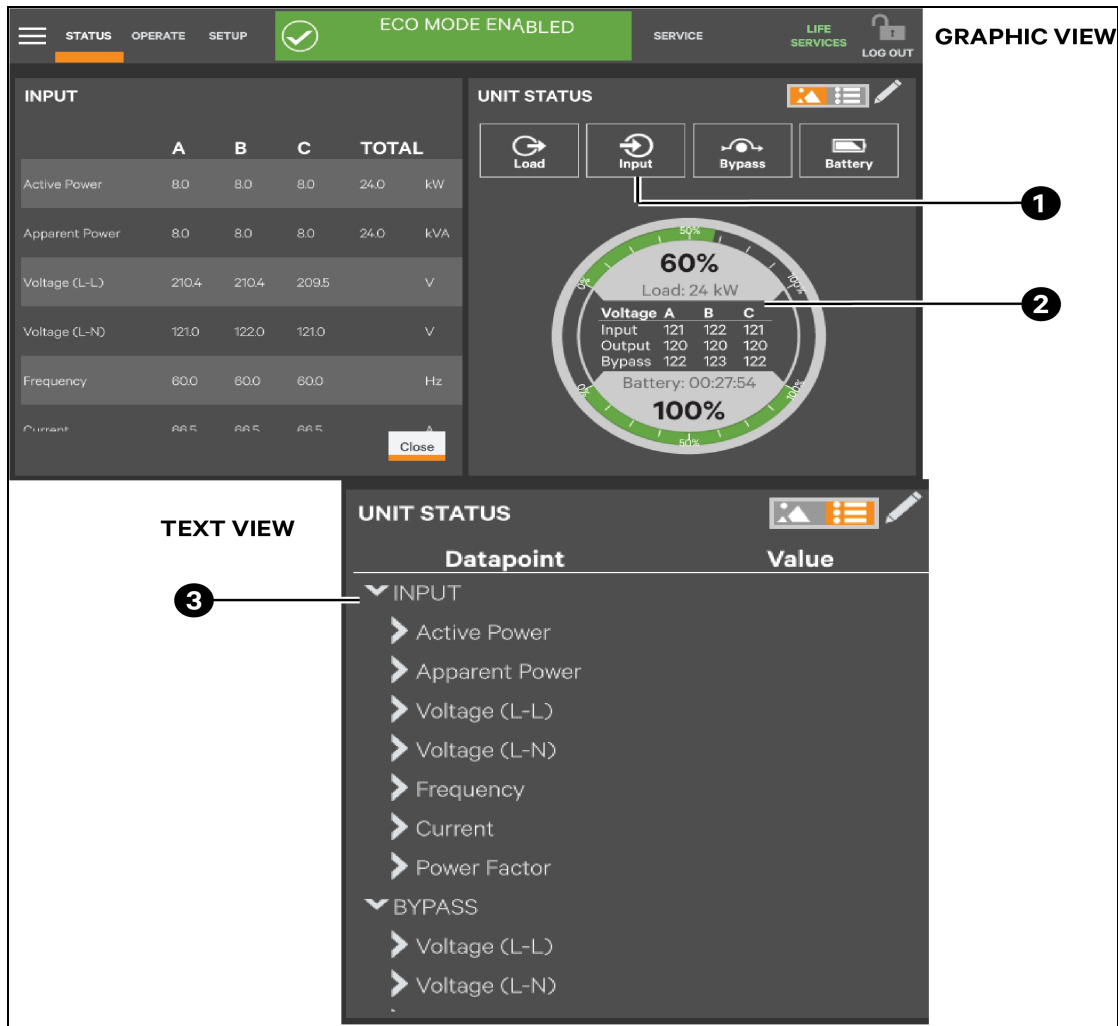

ITEM	DESCRIPTION
1	Touch the Input icon to reveal the information at left.
2	Some data in the columns at left is summarized in the Status Gauge.
3	Data in the columns in the graphic view is visible in the text view by expanding the parameter. Here, INPUT has been expanded.

Table 4.2 INPUT Menus

Active Power	Apparent Power	Voltage (L-L)	Voltage (L-N)
Active Power A	Apparent Power A	Voltage (A-B)	Voltage (A-N)
Active Power B	Apparent Power B	Voltage (B-C)	Voltage (B-N)
Active Power C	Apparent Power C	Voltage (C-A)	Voltage (C-N)
Active Power Total	Apparent Power Total	—	
Frequency	Current	Power Factor	

Table 4.2 INPUT Menus (continued)

Frequency A	Current A	Power Factor A	
Frequency B	Current B	Power Factor B	
Frequency C	Current C	Power Factor C	

Figure 4.6 UNIT STATUS—Bypass Details

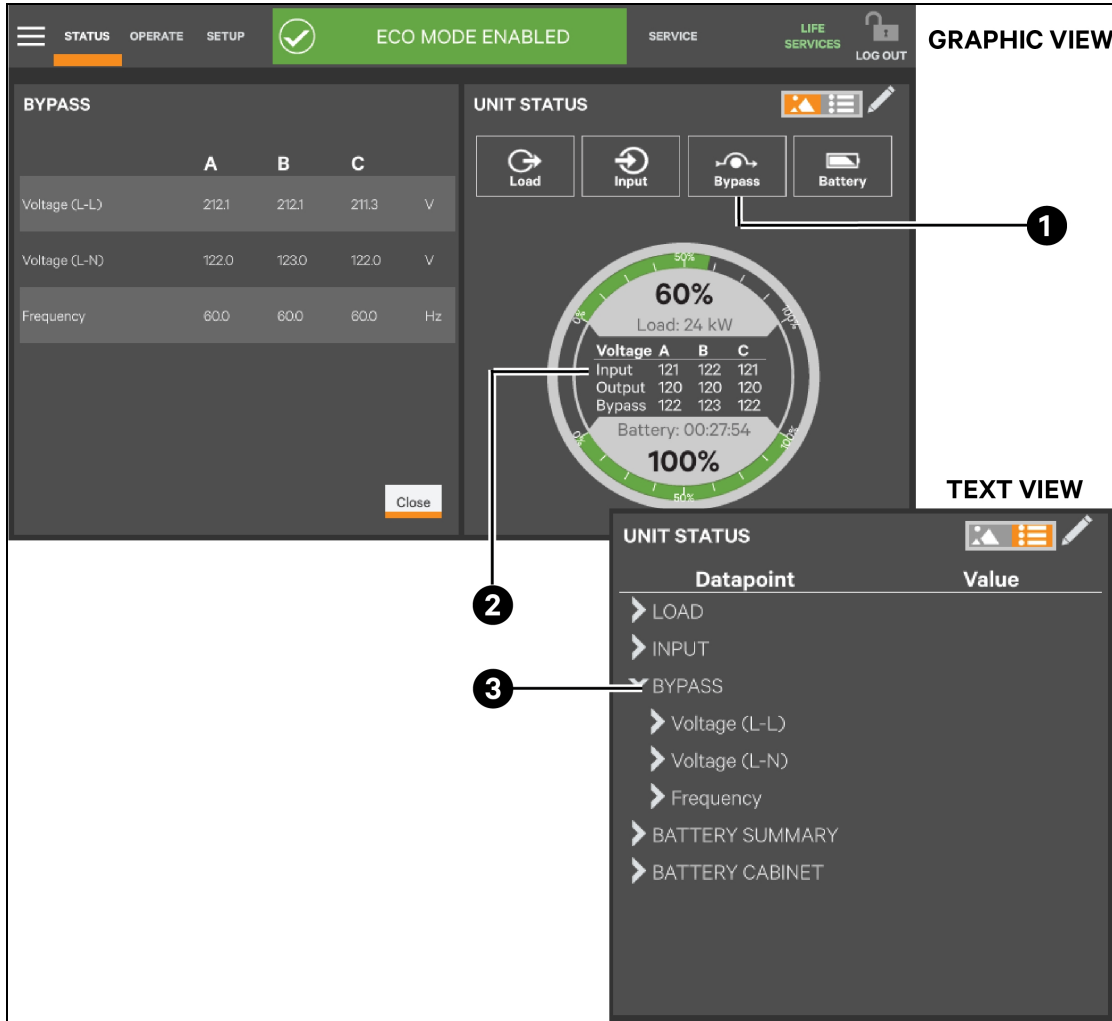

ITEM	DESCRIPTION
1	Touch the Bypass icon to reveal the information at left.
2	Some data in the columns at left is summarized in the Status Gauge.
3	Data in the columns in the graphic view is visible in the text view by expanding the parameter. Here, BYPASS has been expanded.

Table 4.3 BYPASS Menus

Voltage (L-L)	Voltage (L-N)	Frequency
Voltage (A-B)	Voltage (A-N)	Frequency A
Voltage (B-C)	Voltage (B-N)	Frequency B
Voltage (C-A)	Voltage (C-N)	Frequency C

Figure 4.7 UNIT STATUS—Battery Details

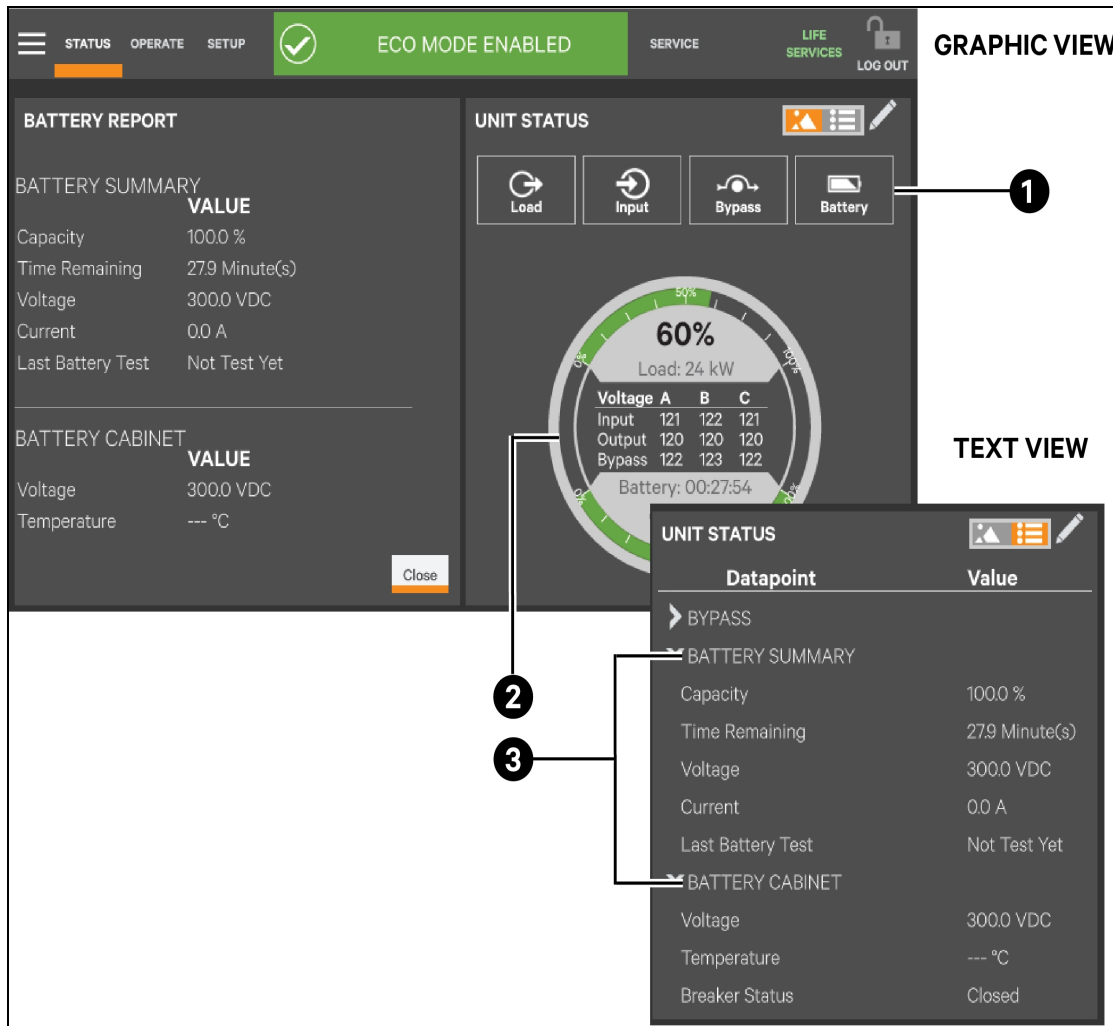

ITEM	DESCRIPTION
1	Touch the Battery icon to reveal the information at left.
2	Some data in the pane at left is summarized in the Status Gauge.
3	Data in the columns in the graphic view is visible in the text view by expanding the parameter. Here, BATTERY SUMMARY and BATTERY CABINET has been expanded.

Figure 4.8 UNIT STATUS—Environmental Details

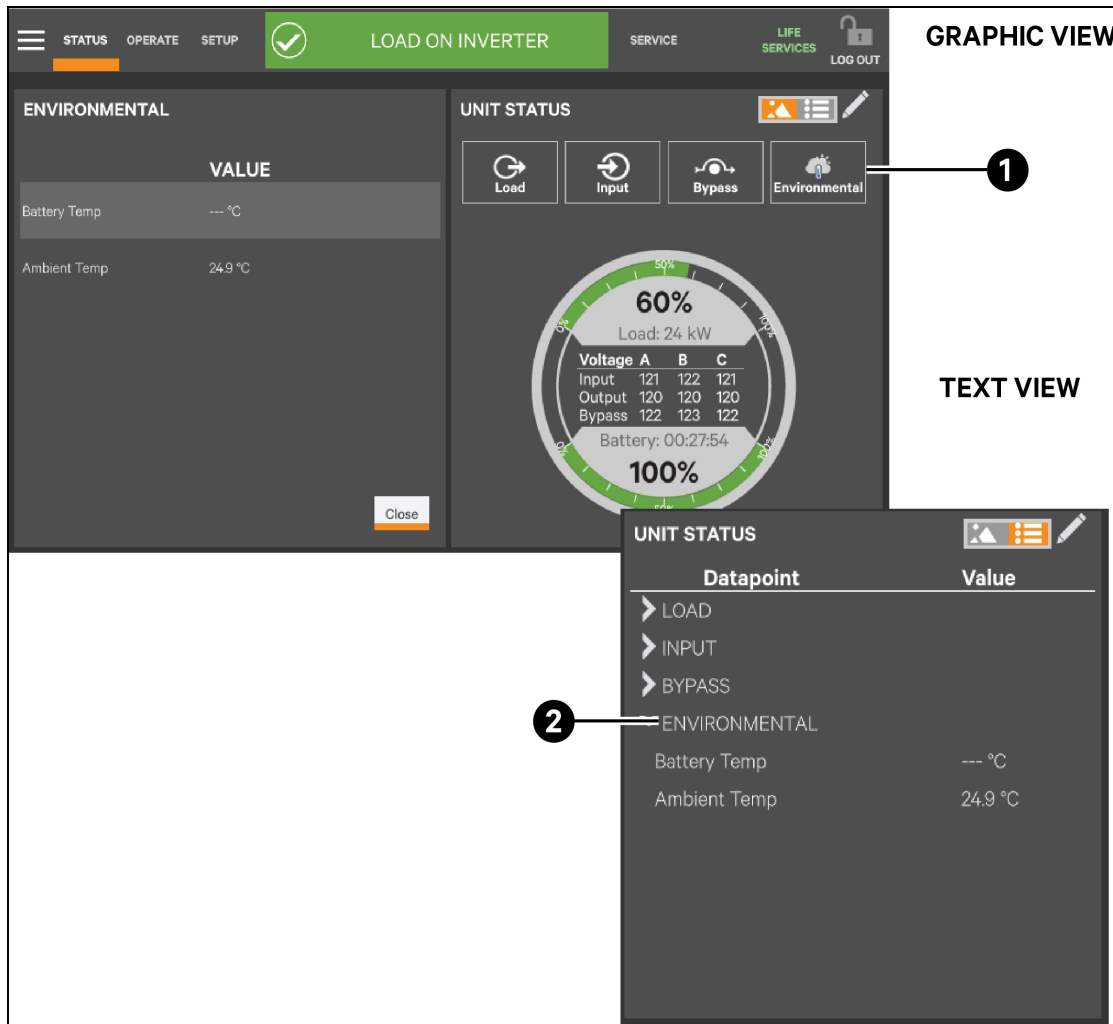

ITEM	DESCRIPTION
1	Touch the Environmental icon to reveal the information at left.
2	Data in the columns in the graphic view is visible in the text view by expanding the parameter. Here, ENVIRONMENTAL has been expanded.

4.3 Logs—Events and Log-In Times

The Context Menu, when opened from the STATUS pane, permits viewing a log of alarms and events that have occurred on the UPS. The log includes the date and time of occurrence, type (alarm or event), an Event ID, component affected and a description of the alarm or event. The information is available to all users, including Observers, those without a log-in passcode.

Events can be sorted by any of the associated information or filtered by severity (Status, Alarm and Fault) or by component affected (bypass, monitoring or module); see [Logs—Filtering and Sorting Events](#) on page 57).

The Context Menu, when opened from the STATUS pane also permits seeing when various users logged in and logged out—available by touching Audit Log.

To view the alarms or events:

1. Navigate to the *STATUS* pane.
2. Touch the *Context Menu* icon.
3. Touch the *Log to view: Events or Logs*, which includes the *Audit Log* and *UPS Event Log*; see **Figure 4.9** below .
4. Touching *Events* opens the list of events and alarms; touching *Logs* permits viewing the
5. *Audit Log* or the *UPS Event Log*.

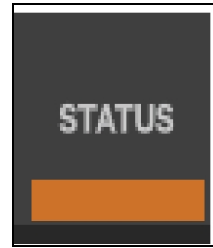

Figure 4.9 View Alarms, Events, Log-out Times

The figure illustrates the navigation process through the control panel's status and log screens. It shows three sequential screens:

- Screen 1:** A 'Status' menu with a home icon and a circled '1' next to it. The menu contains 'Events' and 'Logs' options. An arrow points from 'Events' to the next screen.
- Screen 2:** The 'EVENTS' screen. The top bar shows 'STATUS OPERATE SETUP' and a green 'LOAD ON INVERTER' button. Below the header are 'Reset Fault', 'Silence', and 'Filter' buttons. The main content is a table with columns: Date/Time, Type, Event ID, Component, and Description.

Date/Time	Type	Event ID	Component	Description
11/4/20 12:30 PM	✓	159	MON	Silence Active
11/4/20 12:30 PM	✓	163	MON	Load on Inverter
- Screen 3:** The 'Logs' menu with a back arrow and 'Audit Log' and 'Event Log' options. An arrow points from 'Event Log' to the next screen.
- Screen 4:** The 'EVENT LOG' screen. The top bar shows 'STATUS OPERATE SETUP' and a green 'ECO MODE ENABLED' button. Below the header are 'Export' and 'Filter' buttons. The main content is a table with columns: Date/Time, Type, ID, Status, Component, and Description.

Date/Time	Type	ID	Status	Component	Description
11/4/20 12:30 PM	Info	159	Set	MON	Silence Active
11/4/20 12:30 PM	Info	163	Set	MON	Load on Inverter

ITEM	DESCRIPTION
1	Touch Events or Logs

4.3.1 Logs—Filtering and Sorting Events

The Events Log permits sorting Events and Filtering Events to ease understanding how the UPS is operating.

To sort events, touch on or just to the right of any of the headings—Type, Event ID, Component or Description. A small arrow will appear beside the heading, indicating that the Events have been sorted (see **Figure 4.10** below).

Figure 4.10 Sorting and Filtering Events

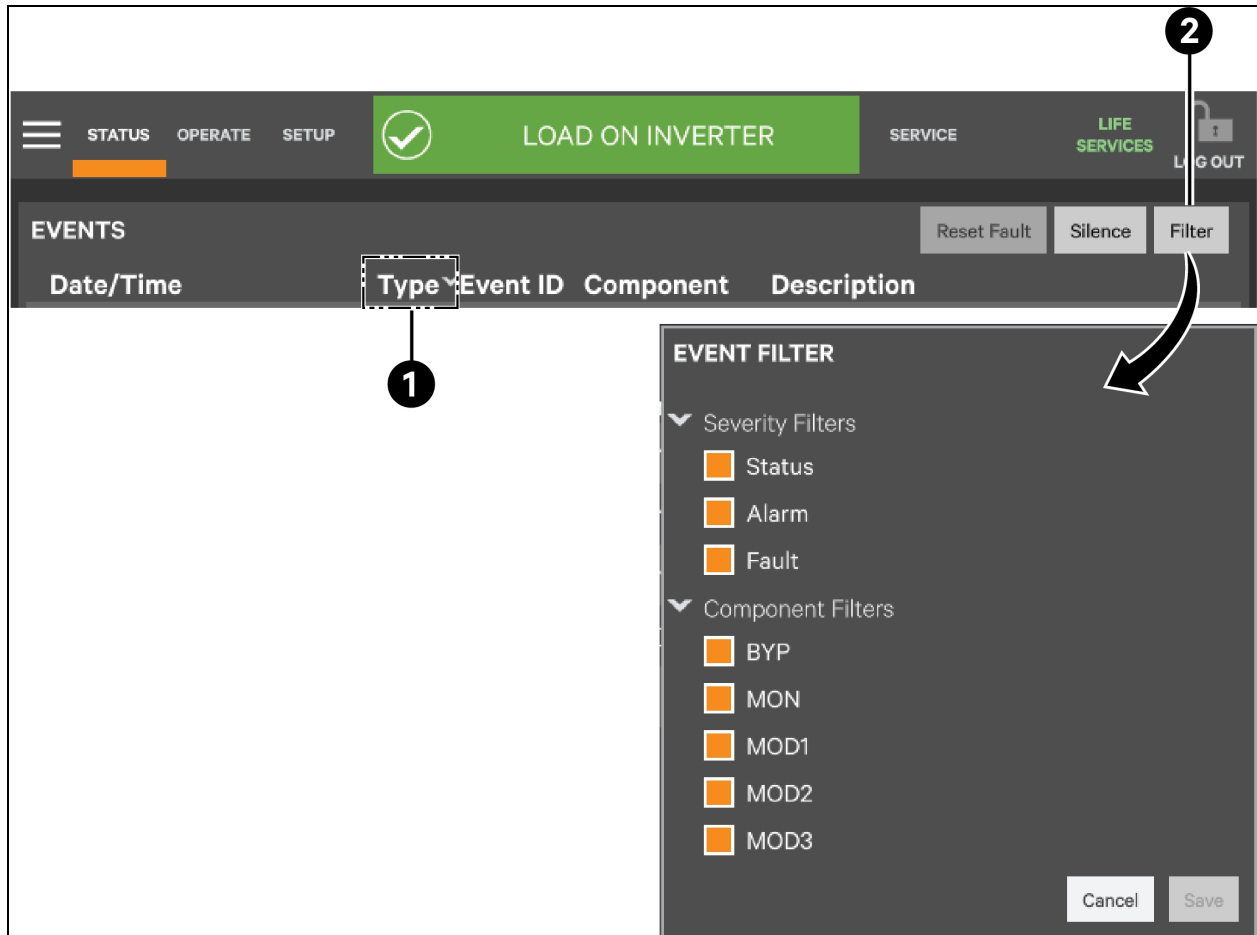

ITEM	DESCRIPTION
1	Arrow shows events sorted by type
2	Touch the Filter button to filter events by any of the parameters in the drop-down

Sorting a menu follows this logic:

- If sorting by component, the data then sorts by severity, then by date/time.
- If sorting by date/time, the data then sorts by component, then by severity.
- If sorting by type, the data then sorts by component, then by date/time.
- If sorting by description, the data then sorts by date/time.
- If sorting by event id, the data then sorts by date/time.

4.3.2 Logs—Exporting Event and Audit Logs

The Touchscreen Control Panel records and retains information about alarms, events and user log-in and log out. Users of any access level can export these logs as either XML or CSV files for analysis or record keeping. XML files may be opened with most text editing programs; CSV files may be opened with a spreadsheet program, such as Microsoft® Excel™.

To export an Event Log or Audit Log:

1. Navigate to *STATUS>Logs*, then choose the log to be exported, either the *Event Log* or *Audit Log*.
2. Touch the *Export* button at the top right of the screen.
3. In the EXPORT FILE screen that opens:
 - a. Name the file in the *Save As* box (an on-screen keyboard will appear).
 - b. Choose the destination (this may be a memory stick inserted into the Touchscreen Control Panel).
 - c. Choose CSV or XML in the *Format* box.
 - d. Touch *Save*.

Figure 4.11 Exporting Logs

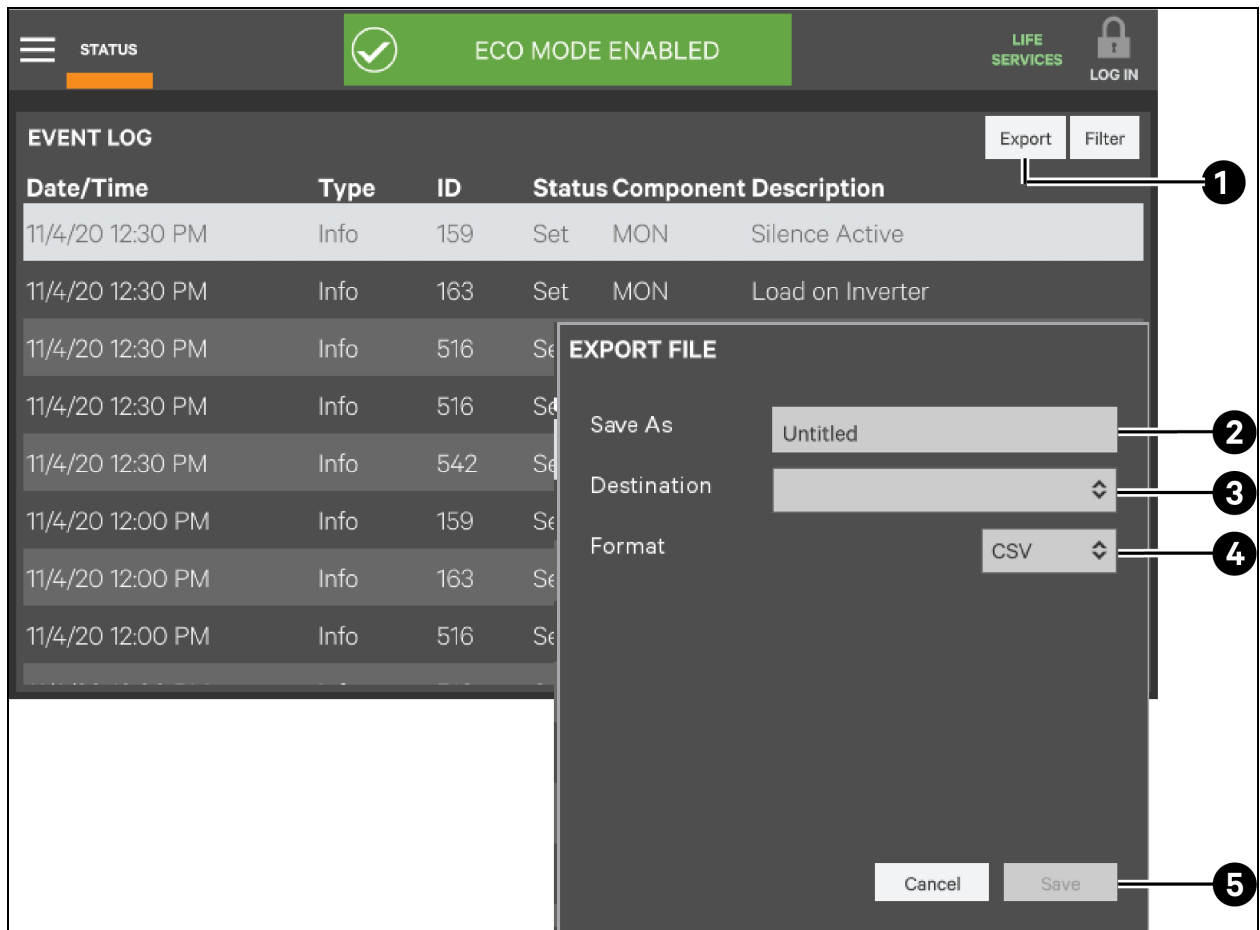

ITEM	DESCRIPTION
1	Touch the Export
2	Name the File
3	Choose the destination
4	Choose the format
5	Touch Save

This page intentionally left blank

5 Viewing UPS Component Status

The animated mimic screen permits viewing details about the main components installed in the UPS and configured in the Touchscreen Control Panel. The data list opens on the opposite side of the screen and, for most parameters, expands to show all details for the component touched.

Component information may also be viewed by going to STATUS Menu and touching COMPONENTS.

Figure 5.1 UNIT STATUS—Main Input Details

The screenshot displays the UPS control panel interface. At the top, there are navigation tabs: STATUS (highlighted), OPERATE, and SETUP. A green bar indicates 'OPERATION NORMAL'. On the right, there are 'SERVICE', 'LIFE SERVICES', and 'LOG OUT' options.

The main area is divided into two sections:

- SINGLE SYSTEM:** A schematic diagram of the UPS system. It shows an input section with components labeled Q1, Q2, Q3, and Q5. A battery bank (BCB) is connected to the system. A large black arrow points from the input section of the diagram to the 'INPUT DETAILS' panel.
- INPUT DETAILS:** A panel showing the status and parameters of the input component.

Status	Component
▼ ●	Input
	Fault Number: 0
	Alarm Number: 0
	Voltage: 220.0 220.0 220.0 V
	Main Input Current: 28.9 43.4 57.9 A
	Frequency: 50.0 50.0 50.0 Hz
	Main Input Power Factor: 0.98 0.99 0.97
▶ ●	Bypass
▶ ●	Battery
▶ ●	Output

At the bottom left, there is a 'Legend' section. At the bottom right, there is a 'Close' button.

Figure 5.2 UNIT STATUS—Output Details

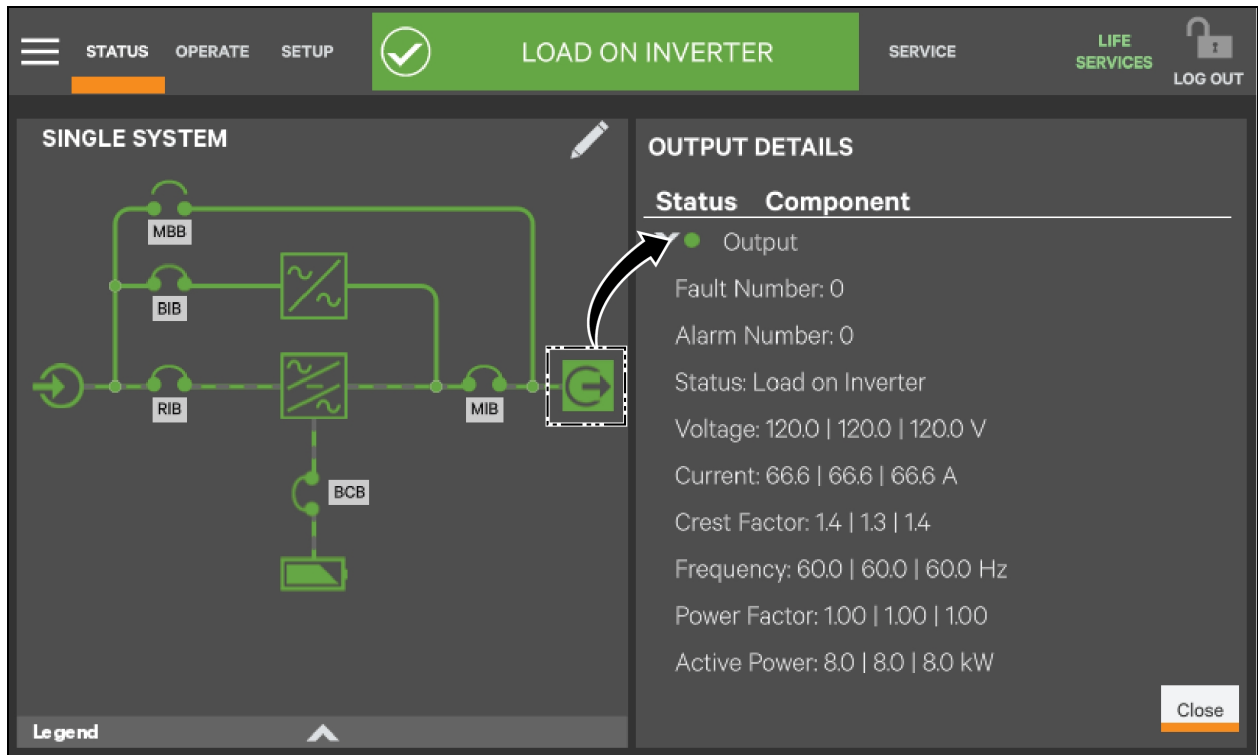

Figure 5.3 UNIT STATUS—Bypass Details

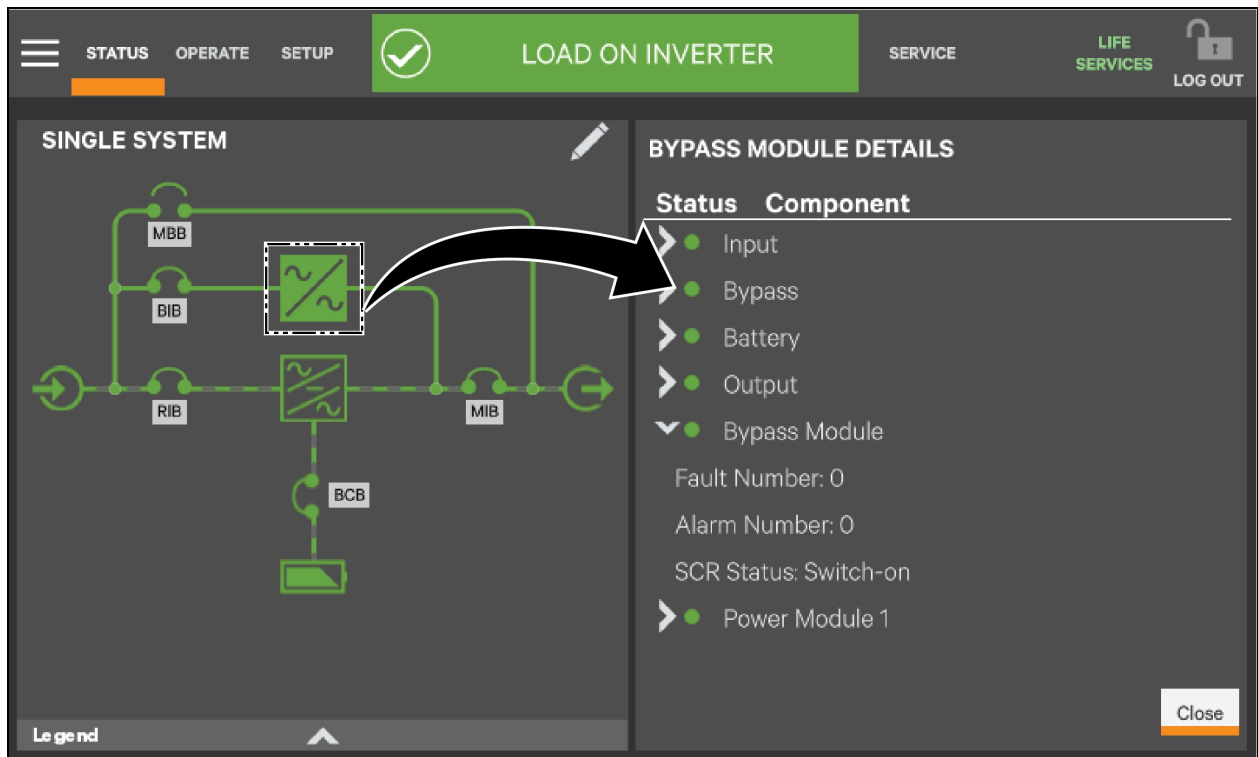

Figure 5.4 UNIT STATUS—Power Module Details

The screenshot displays the 'UNIT STATUS' interface. At the top, there are navigation tabs: STATUS (selected), OPERATE, and SETUP. A green bar indicates 'LOAD ON INVERTER'. On the right, there are 'SERVICE', 'LIFE SERVICES', and 'LOG OUT' options. The main area is split into two panels. The left panel, 'SINGLE SYSTEM', shows a schematic diagram with components labeled MBB, BIB, RIB, MIB, and BCB. A dashed box highlights a component in the diagram, with a large arrow pointing to the 'POWER MODULE DETAILS' panel on the right. The 'POWER MODULE DETAILS' panel has a table with columns 'Status' and 'Component'. It shows 'Bypass Module' with a green dot and 'Power Module 1' with a green dot and a downward arrow. Below this, it lists: Fault Number: 0, Alarm Number: 0, Rectifier Status: On, Inverter Status: On, Charger Status: On, Discharger Status: Off, Input Voltage: 121.0 | 122.0 | 121.0 V, and Input Current: 66.5 | 66.5 | 66.5 A. A 'Close' button is at the bottom right of this panel. A callout '1' points to the 'Close' button.

ITEM	DESCRIPTION
1	Expand component list to see additional details.

Figure 5.5 UNIT STATUS—Battery Details

The screenshot displays the 'UNIT STATUS' screen with the 'LOAD ON INVERTER' indicator active. The 'SINGLE SYSTEM' diagram shows a battery bank connected to the inverter through a circuit breaker (CB) and monitoring relays (MBB, BIB, RIB, MIB). The 'BATTERY DETAILS' panel provides the following information:

Status	Component
●	Battery
Fault Number: 0	
Alarm Number: 0	
Status: Float Charging	
Voltage: 300.0 VDC	
Current: 0.0 A	
Temperature: --- °C	
Capacity: 100.0 %	
Time Remaining: 27.9 Minute(s)	
▶ ●	Output

Legend

Close

6 Parallel System

6.1 Parallel System Mimic

The animated mimic display, the default view for the control, shows each configured major component of the UPS system, for both single-module and multi-module systems. The mimic display is the same for all access levels. The power path is shown by animated lines; moving dashes show the active power path. Touching a component (except a breaker) brings up details about the component's status. Breakers are shown as open or closed (see **Figure 6.1** below), but they are not interactive.

Components in the mimic display signify their operational status by their color, green, amber or red. **Table 7.1** on page 71 through **Table 7.3** on page 74 describe the various states of the indicators.

The animated mimic display can be changed to any of five other views: Status, Alarms, Run Hours, Event Log and Battery Cycle Monitor Summary (see [Customizing the Display](#) on page 17).

Figure 6.1 CE Parallel System View Breakers

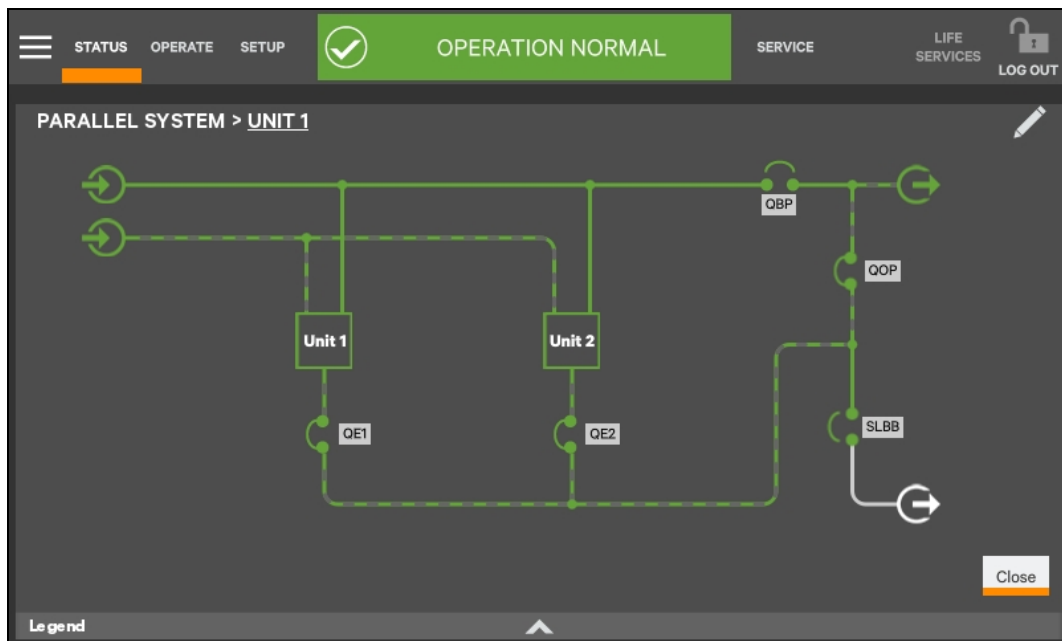

Breaker	Description
QE1	Unit 1 Output Switch
QE2	Unit 2 Output Switch
SLBB	System Load Bank Breaker
QOP	System Output Isolation Switch
QBP	System Maintenance Bypass Switch
NOTE: Breakers in a system are determined during setup and can be installed or removed by Service.[MN1]	

Figure 6.2 UL Parallel System View Breakers

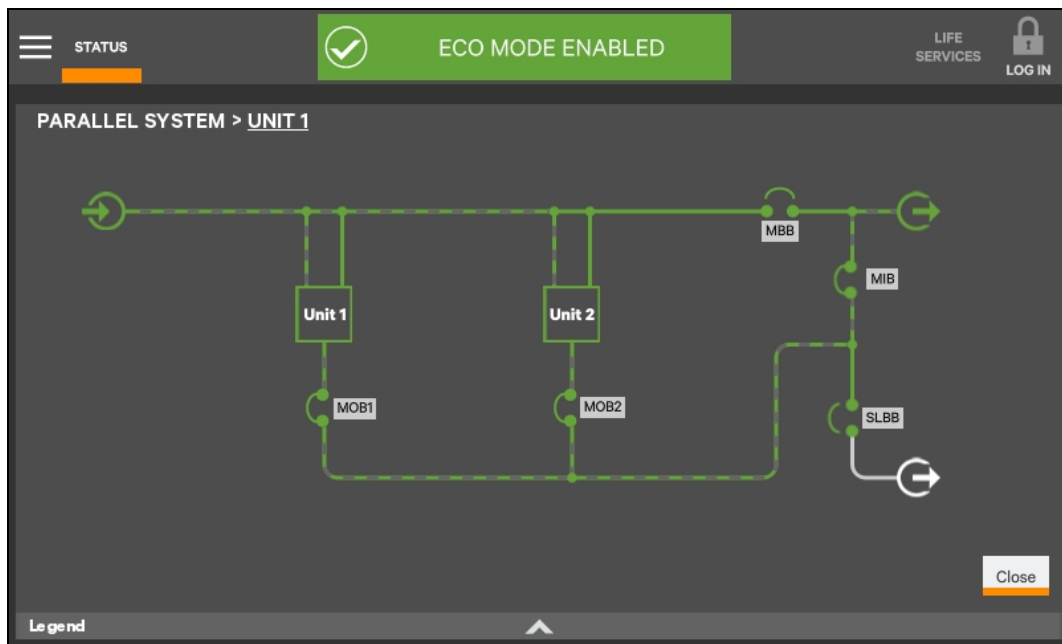

Breaker	Description
MOB1	Unit 1 Module Output Breaker
MOB2	Unit 2 Module Output Breaker
SLBB	System Load Bank Breaker
MIB	MIB – System Maintenance Isolation Breaker
MBB	System Maintenance Bypass Breaker

NOTE: Breakers in a system are determined during setup and can be installed or removed by Service.[MN1]

Figure 6.3 Single Input

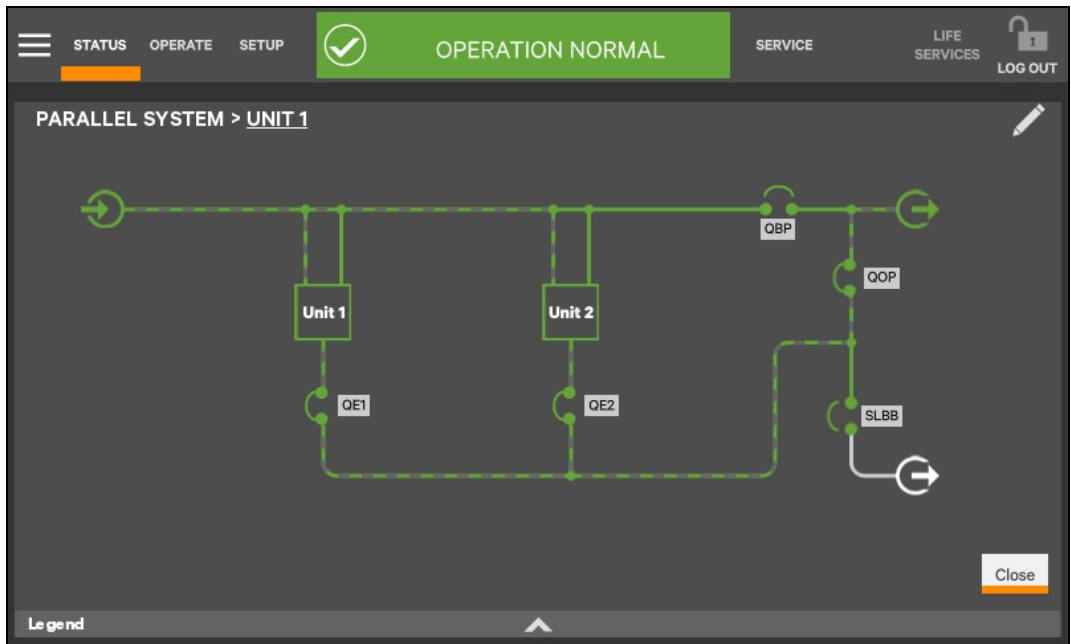

The user can view Parallel System information by selecting the interactive input and output icons or can view individual unit information by selecting the unit icons.

Figure 6.4 System Values

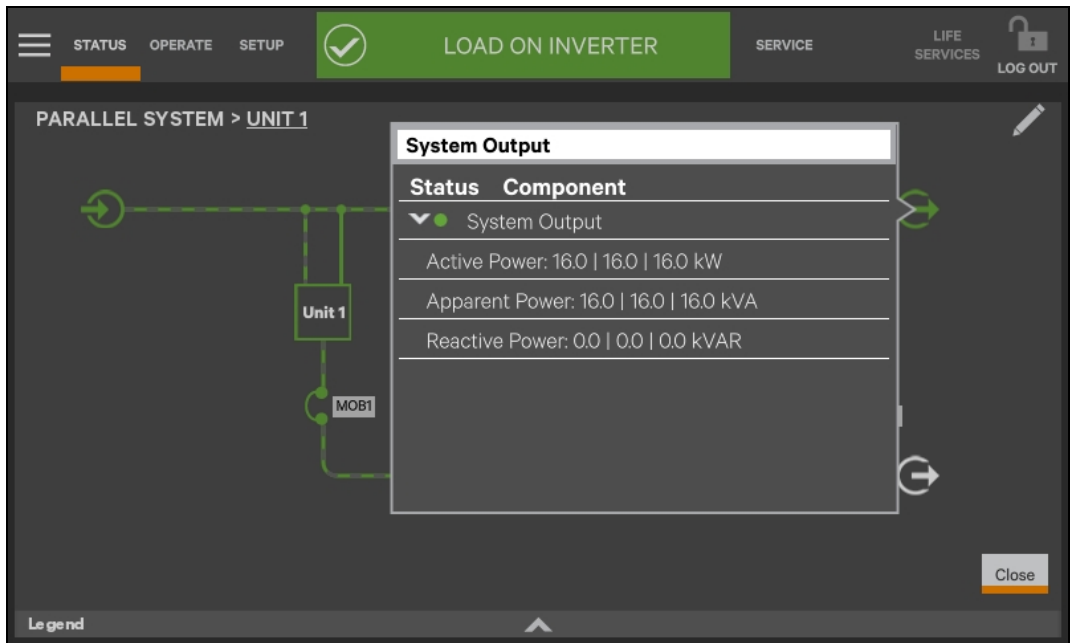

Press output icon, HMI will show system values.

Press the "Parallel System" text, HMI will display parallel system view. (single UPS will only display SINGLE SYSTEM)

Figure 6.5 Parallel System

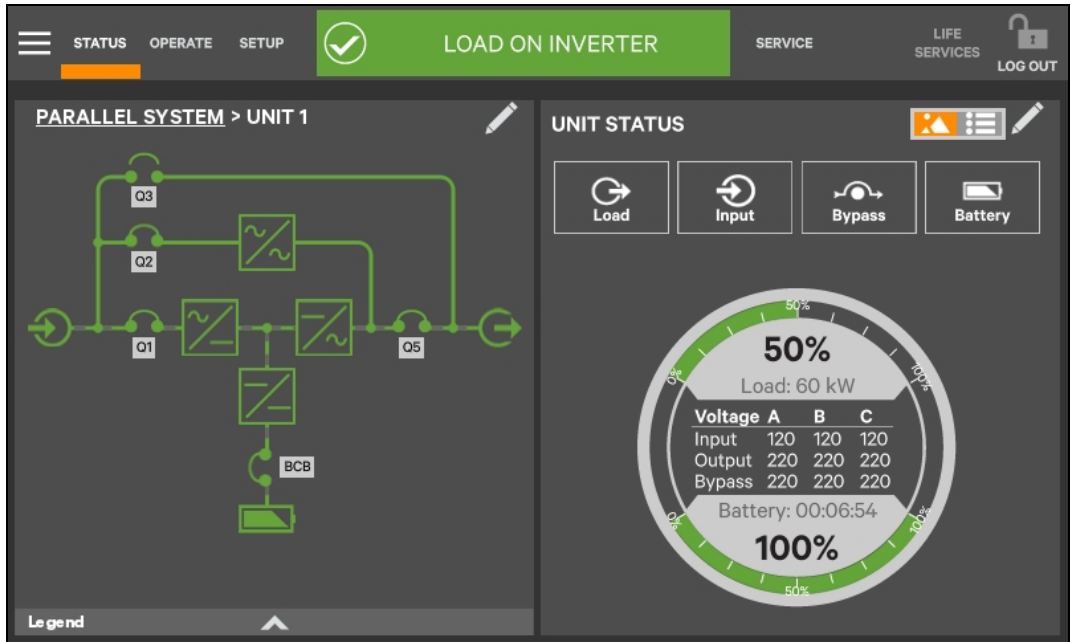

When viewing an individual unit, view, the user can navigate back to the Parallel System view by selecting Parallel System.

In parallel system view, press local UPS icon, HMI will display local UPS online diagram.

Press other UPS icon, HMI will display other UPS's information.

Figure 6.6 Displaying Unit Information for Parallel System

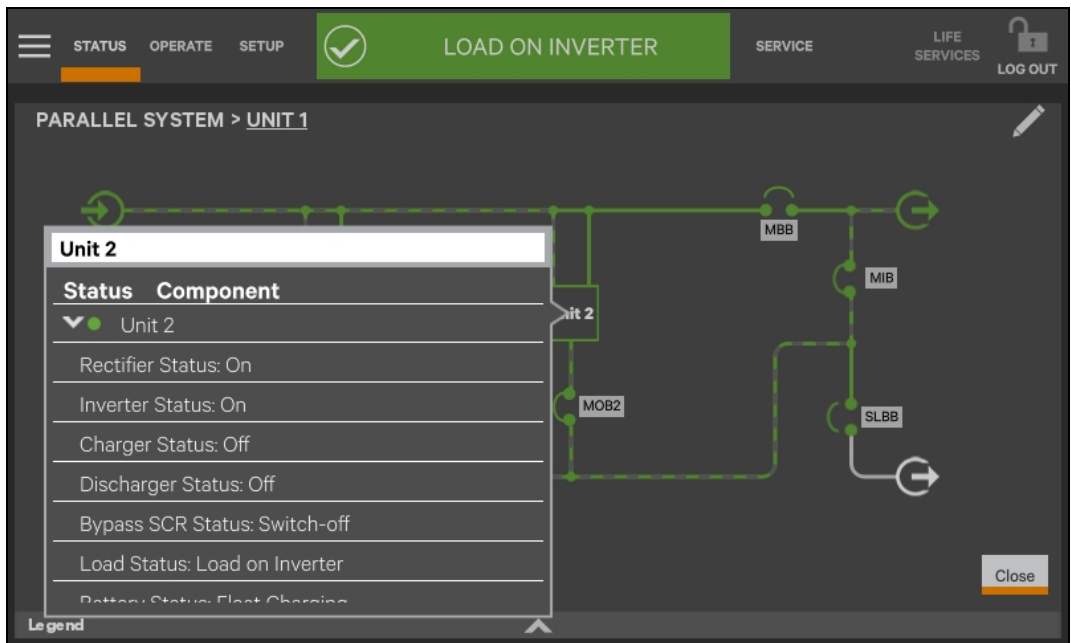

In parallel system view, press local UPS icon, HMI will display local UPS online diagram.

Press other UPS icon, HMI will display other UPS's information.

The below table displays the available information about the UPS from the Parallel System View. For more information, view the local information for the UPS or the remote monitoring interface.

Displaying Unit Information for Parallel System	
Battery Status	Output Apparent Power
Input Voltage	Output Reactive Power
Input Current	Output Load Percentage
Input Frequency	Battery Voltage
Input Power Factor	Battery Current
Bypass Voltage	Battery Temperature
Bypass Frequency	Battery Capacity
Output Current	Battery Time Remaining
Output Frequency	Output Voltage
Output Power Factor	Output Current
Output Active Power	

Figure 6.7 Displaying Unit Status for Parallel System

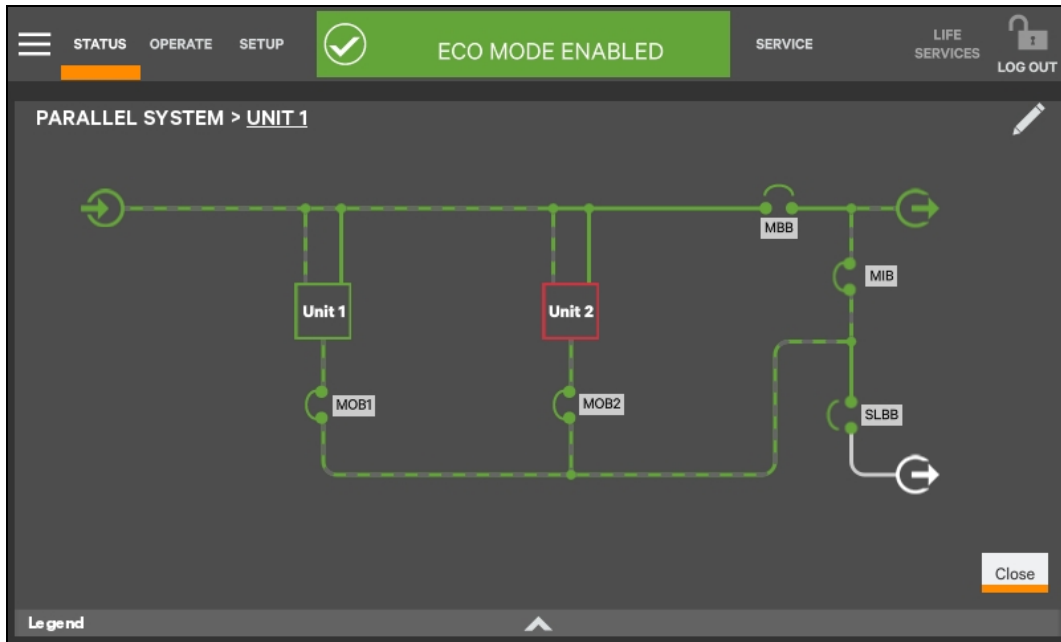

Units Icon Color	Status
Green	Normal State
Yellow	Warning State
Red	Fault State

This page intentionally left blank

7 Status Bar Composition

The status bar indicates UPS status by:

- scrolling messages to inform viewers; see **Table 7.1** below through **Table 7.3** on page 74 .
- changing color; green for normal, yellow for warning and red for alarm
- showing an icon inside the bar; shown at right.



7.1 Status Bar Messages

Up to three messages may scroll through the status bar to the right of the status icon. Each message will have a duration of four seconds, except they change immediately if the system's status changes.

Table 7.1 Normal Status Messages

Message 1	Message 2	Message 3	Definition
LOAD ON INVERTER	FREQUENCY CONVERTER MODE ACTIVE	OUTPUT FREQUENCY X HZ	This system is in normal operating mode, supplied by the inverter, and operating as a frequency converter.
LOAD ON INVERTER	X MODE ENABLED	—	This system is in normal operating mode, supplied by the inverter, and has the specified energy savings modes configured and enabled.
LOAD ON INVERTER	X MODE ACTIVE	—	This system is in normal operating mode, supplied by the inverter, and has the specified energy savings modes active.
LOAD ON INVERTER	OPERATION NORMAL	—	This system is in normal operating mode, supplied by the inverter, and has no special configurations.
LOAD ON BYPASS	X MODE ACTIVE	—	This system is in normal operating mode, supplied by the bypass, and has the specified energy savings modes active.
LOAD ON BATTERY	BATTERY TEST IN PROGRESS	—	This system is in normal operating mode, supplied by the inverter via the battery, and a battery test is running.
LOAD OFF	X MODE ACTIVE	—	This system is in normal operating mode, load not supplied by this unit, and has the specified energy savings modes active.
LOAD ON INVERTER	SERVICE MODE ACTIVE	—	This system is in normal operating condition on the inverter with the service mode activated.
LOAD ON INVERTER	TEST MODE ACTIVE	—	This system is in normal operating mode, for the current test mode that is activated.
LOAD ON OTHER MODULE	—	—	The system is in normal operating mode, but the load is supplied by another UPS module.
LOAD ON BATTERY	X MINUTES REMAINING	—	This system is in warning operating mode, supplied by the inverter via the battery. There are X minutes of calculated run time remaining. This is displayed before the battery low-voltage warnings are generated.

Table 7.2 Warning Status Messages

Message 1	Message 2	Message 3	Definition
LOAD ON INVERTER	OUTPUT OVERLOAD	—	This system is in warning operating mode, supplied by the inverter, and the system is in overload. This means the system will go off inverter at some point.
LOAD ON INVERTER	OVER TEMPERATURE	—	This system is in warning operating mode, supplied by the inverter, and at least one part of the system is incurring an overtemperature alarm. This means if the temperature does not recover, the system will go off inverter at some point.
LOAD ON INVERTER	ALARM ACTIVE – WARNING	VIEW EVENT LOG FOR DETAILS	This system is in warning operating mode, supplied by the inverter, and has an active alarm. This means the system is operating, but something was detected to be outside of normal.
LOAD ON BYPASS	LOAD MANUALLY TRANSFERRED TO BYPASS	LOAD UNPROTECTED	This system is in warning operating mode, supplied by the bypass. The user transferred the load to the bypass so the system cannot protect itself from source variations.
LOAD ON BATTERY	X MINUTES REMAINING	—	This system is in warning operating mode, supplied by the inverter via the battery. There are only X minutes of calculated run time remaining. This is used before the battery low voltage warnings are generated
LOAD ON BYPASS	ALARM ACTIVE – WARNING	VIEW EVENT LOG FOR DETAILS	This system is in warning operating mode, supplied by the bypass, and has an active alarm. This means the system is operating after a transfer to bypass, and something was detected to be outside of normal.
LOAD ON INVERTER	X MODE ENABLED	ALARM ACTIVE – WARNING	This system is in warning operating mode, supplied by the inverter, the specified energy saving modes is configured and enabled, and has an active alarm. This means the system is operating, but something was detected to be outside of normal.
LOAD ON INVERTER	X MODE ACTIVE	ALARM ACTIVE – WARNING	This system is in warning operating mode, supplied by the inverter, the specified energy saving modes is active, and has an active alarm. This means the system is operating, but something was detected to be outside of normal.
LOAD ON BYPASS	X MODE ACTIVE	ALARM ACTIVE – WARNING	This system is in warning operating mode, supplied by the bypass, the specified energy saving modes is active, and has an active alarm. This means the system is operating, but something was detected to be outside of normal.
LOAD OFF	X MODE ACTIVE	ALARM ACTIVE – WARNING	This system is in warning operating mode, load off, the specified energy saving modes is active, and has an active alarm. This means the system is operating, but something was detected to be outside of normal.
LOAD ON INVERTER	TEST MODE ACTIVE	ALARM ACTIVE – WARNING	This system is in warning operating mode, supplied by the inverter, running in a system test mode, and has an active alarm. This means the system is in TEST MODE, and something was detected to be outside of normal test operations.
LOAD ON INVERTER	SERVICE MODE ACTIVE	ALARM ACTIVE – WARNING	This system is in warning operating mode, supplied by the inverter, running in a service mode, and has an active alarm. This means the system is in SERVICE MODE, and something was detected to be outside of normal test operations.
LOAD ON BYPASS	TEST MODE ACTIVE	ALARM ACTIVE – WARNING	This system is in warning operating mode, supplied by the bypass, running in a system test mode, and has an active alarm. This means the system is in TEST MODE, and something was detected to be outside of normal test operations.

Table 7.2 Warning Status Messages (continued)

Message 1	Message 2	Message 3	Definition
LOAD ON BYPASS	SERVICE MODE ACTIVE	ALARM ACTIVE – WARNING	This system is in warning operating mode, supplied by the bypass, running in a service mode, and has an active alarm. This means the system is in SERVICE MODE, and something was detected to be outside of normal test operations.
LOAD ON BATTERY	TEST MODE ACTIVE	ALARM ACTIVE – WARNING	This system is in warning operating mode, supplied by the battery, running in a system test mode, and has an active alarm. This means the system is in TEST MODE, and something was detected to be outside of normal test operations.
LOAD ON BATTERY	SERVICE MODE ACTIVE	ALARM ACTIVE – WARNING	This system is in warning operating mode, supplied by the battery, running in a service mode, and has an active alarm. This means the system is in SERVICE MODE, and something was detected to be outside of normal test operations.
LOAD ON INVERTER	FREQUENCY CONVERTER MODE ACTIVE	ALARM ACTIVE – WARNING	This system is in warning operating mode, supplied by the inverter, operating as a frequency converter, and has an active alarm. This means the system is operating, but something was detected to be outside of normal.
LOAD ON MAINT BYPASS	ALARM ACTIVE - WARNING	VIEW EVENT LOG FOR DETAILS	This system is in warning operating mode, supplied by the maintenance bypass, and has an active alarm.
LOAD ON OTHER MODULE	ALARM ACTIVE – WARNING	VIEW EVENT LOG FOR DETAILS	This module is in warning operating mode. The load is supplied by other UPS modules, and has an active warning.
LOAD OFF	ALARM ACTIVE – WARNING	VIEW EVENT LOG FOR DETAILS	This module is in warning operating mode. The load is not supplied, and has an active warning.

Table 7.3 Critical Status Messages

Message 1	Message 2	Message 3	Definition
LOAD ON INVERTER	OUTPUT OVERLOAD	TRANSFER TO BYPASS PENDING	This system is in critical operating mode, supplied by the inverter, and the load is about to be transferred to the bypass due to overload timeouts.
LOAD ON INVERTER	FAULT ACTIVE - CRITICAL	VIEW EVENT LOG FOR DETAILS	This system is in critical operating mode, supplied by the inverter. There is a critical fault raised in the system that the user needs to view.
LOAD ON BYPASS	LOAD AUTOMATICALLY TRANSFERRED TO BYPASS	VIEW EVENT LOG FOR DETAILS	This system is in critical operating mode, supplied by the bypass. The system moved the load to the bypass due to a critical fault in the system.
LOAD ON BYPASS	FAULT ACTIVE - CRITICAL	VIEW EVENT LOG FOR DETAILS	This system is in critical operating mode, supplied by the bypass. The system is running on bypass not due to auto-transfer, and a critical fault is active in the system.
LOAD ON BATTERY	X MINUTES REMAINING	LOAD SHUTDOWN IMMINENT	This system is in critical operating mode, supplied by the inverter via the battery. The battery is extremely low and the load will turn off or transfer to bypass soon.
LOAD OFF	FAULT ACTIVE - CRITICAL	VIEW EVENT LOG FOR DETAILS	This system is in critical operating mode, load not supplied by this unit. The load is not supplied for any reason and a critical fault is active.
LOAD OFF	—	—	This system is in critical operating mode, load not supplied by this unit. The load is not supplied and no active fault is present
LOAD ON BATTERY	FAULT ACTIVE - CRITICAL	VIEW EVENT LOG FOR DETAILS	This system is in critical operating mode, supplied by the battery. The system is running on inverter via the battery, is not in imminent shutdown, and a critical fault is active in the system.
LOAD ON INVERTER	X MODE ENABLED	FAULT ACTIVE - CRITICAL	This system is in critical operating mode, supplied by the inverter. The system is running on inverter, with the specified energy saving mode configured and enabled, and a critical fault is active in the system.
LOAD ON INVERTER	X MODE ACTIVE	FAULT ACTIVE - CRITICAL	This system is in critical operating mode, supplied by the inverter. The system is running on inverter, with the specified energy saving mode active, and a critical fault is active in the system.
LOAD ON BYPASS	X MODE ACTIVE	FAULT ACTIVE - CRITICAL	This system is in critical operating mode, supplied by the bypass. The system is running on bypass, with the specified energy saving mode active, and a critical fault is active in the system.
LOAD OFF	X MODE ACTIVE	FAULT ACTIVE - CRITICAL	This system is in critical operating mode. The system is NOT running, with the specified energy saving mode active, and a critical fault is active in the system.
LOAD OFF	TEST MODE ACTIVE	—	This system is off with a TEST MODE active.
LOAD OFF	SERVICE MODE ACTIVE	—	This system is off with a SERVICE MODE active.
LOAD ON INVERTER	TEST MODE ACTIVE	FAULT ACTIVE - CRITICAL	This system is in critical operating mode, supplied by the inverter, running in a system test mode, and has an active fault. This means the system is in TEST MODE, and something critical was detected to be outside of normal test operations.
LOAD ON INVERTER	SERVICE MODE ACTIVE	FAULT ACTIVE - CRITICAL	This system is in critical operating mode, supplied by the inverter, running in a system service mode, and has an active fault. This means the system is in SERVICE MODE, and something critical was detected to be outside of normal test operations.

Table 7.3 Critical Status Messages (continued)

Message 1	Message 2	Message 3	Definition
LOAD ON BYPASS	TEST MODE ACTIVE	FAULT ACTIVE - CRITICAL	This system is in critical operating mode, supplied by the bypass, running in a system test mode, and has an active fault. This means the system is in TEST MODE, and something critical was detected to be outside of normal test operations.
LOAD ON BYPASS	SERVICE MODE ACTIVE	FAULT ACTIVE - CRITICAL	This system is in critical operating mode, supplied by the bypass, running in a system service mode, and has an active fault. This means the system is in SERVICE MODE, and something critical was detected to be outside of normal test operations.
LOAD ON BATTERY	TEST MODE ACTIVE	FAULT ACTIVE - CRITICAL	This system is in critical operating mode, supplied by the inverter via the battery, running in a system test mode, and has an active fault. This means the system is in TEST MODE, and something critical was detected to be outside of normal test operations.
LOAD ON BATTERY	SERVICE MODE ACTIVE	FAULT ACTIVE - CRITICAL	This system is in critical operating mode, supplied by the inverter via the battery, running in a system service mode, and has an active fault. This means the system is in SERVICE MODE, and something critical was detected to be outside of normal test operations.
LOAD OFF	TEST MODE ACTIVE	FAULT ACTIVE - CRITICAL	This system is in critical operating mode, with LOAD OFF, running in a system test mode, and has an active fault. This means the system is in TEST MODE, and something critical was detected to be outside of normal test operations.
LOAD OFF	SERVICE MODE ACTIVE	FAULT ACTIVE - CRITICAL	This system is in critical operating mode, with LOAD OFF, running in a system service mode, and has an active fault. This means the system is in SERVICE MODE, and something critical was detected to be outside of normal test operations.
LOAD ON INVERTER	FREQUENCY CONVERTER MODE ACTIVE	FAULT ACTIVE - CRITICAL	This system is in critical operating mode, supplied by the inverter, operating as a frequency converter, and has an active fault. This means the system is operating, but something critical was detected to be outside of normal.
LOAD OFF	FREQUENCY CONVERTER MODE ACTIVE	FAULT ACTIVE - CRITICAL	This system is in critical operating mode, load NOT supplies, operating as a frequency converter, and has an active fault. This means the system is operating, but something critical was detected to be outside of normal.
LOAD ON MAINT BYPASS	FAULT ACTIVE - CRITICAL	VIEW EVENT LOG FOR DETAILS	This system is in critical operating mode, supplied by the maintenance bypass. There is a critical fault raised in the system that the user needs to view.
LOAD ON OTHER MODULE	FAULT ACTIVE - CRITICAL	VIEW EVENT LOG FOR DETAILS	This module is in critical operating mode. The load is supplied by other UPS modules. There is a critical fault raised in the system that the user needs to view.

This page intentionally left blank

Connect with Vertiv on Social Media



<https://www.facebook.com/vertiv/>



<https://www.instagram.com/vertiv/>



<https://www.linkedin.com/company/vertiv/>



<https://www.twitter.com/Vertiv/>



Vertiv.com | Vertiv Headquarters, 1050 Dearborn Drive, Columbus, OH, 43085, USA

© 2021 Vertiv Group Corp. All rights reserved. Vertiv™ and the Vertiv logo are trademarks or registered trademarks of Vertiv Group Corp. All other names and logos referred to are trade names, trademarks or registered trademarks of their respective owners. While every precaution has been taken to ensure accuracy and completeness here, Vertiv Group Corp. assumes no responsibility, and disclaims all liability, for damages resulting from use of this information or for any errors or omissions. Specifications, rebates and other promotional offers are subject to change at Vertiv's sole discretion upon notice.

SL-26200_REV3_02-21