



Liebert® iCOM™

Installer/User Guide

**Intelligent Communication and Monitoring for Liebert® DSE Packaged Solution
DP060, DP400/500**

The information contained in this document is subject to change without notice and may not be suitable for all applications. While every precaution has been taken to ensure the accuracy and completeness of this document, Vertiv assumes no responsibility and disclaims all liability for damages resulting from use of this information or for any errors or omissions.

Refer to local regulations and building codes relating to the application, installation, and operation of this product. The consulting engineer, installer, and/or end user is responsible for compliance with all applicable laws and regulations relating to the application, installation, and operation of this product.

The products covered by this instruction manual are manufactured and/or sold by Vertiv. This document is the property of Vertiv and contains confidential and proprietary information owned by Vertiv. Any copying, use, or disclosure of it without the written permission of Vertiv is strictly prohibited.

Names of companies and products are trademarks or registered trademarks of the respective companies. Any questions regarding usage of trademark names should be directed to the original manufacturer.

Technical Support Site

If you encounter any installation or operational issues with your product, check the pertinent section of this manual to see if the issue can be resolved by following outlined procedures.

Visit <https://www.vertiv.com/en-us/support/> for additional assistance.

TABLE OF CONTENTS

1 Getting Started with Vertiv™ Liebert® iCOM™	1
1.1 Touchscreen Display and User Interface	1
1.2 Touchscreen Status Dial	3
1.2.1 Dial Background Color Status Indication	5
1.3 Control Header	6
1.3.1 Powering On Vertiv™ Liebert® iCOM™ and Logging In/Unlocking Controls	6
1.3.2 Powering On the Thermal Management Unit	7
1.3.3 Powering Off the Thermal Management Unit	8
1.3.4 Logging Out	8
1.3.5 Calibrating the Touchscreen	8
1.3.6 Setting the Date and Time	9
1.3.7 Searching	9
1.4 Using Context Sensitive Help	9
1.5 About Vertiv™ Liebert® iCOM™ Version	10
1.6 Accessing the User, Service, and Advanced Menus	10
1.7 User Menu	10
1.7.1 User menu options	10
1.8 Service Menu	11
1.8.1 Service Menu Options	11
2 User Operation	13
2.1 Viewing and Editing Setpoints for the Cooling Unit	13
2.1.1 Editing Temperature Setpoints	13
2.2 Viewing Unit Alarms	14
2.2.1 To View Alarms	14
2.2.2 Silencing an Audible Alarm	15
2.2.3 Acknowledging Alarms	15
2.3 Viewing the Event Log	16
2.4 Viewing Sensor Data	17
2.5 Managing Run Hours for a Component	17
2.5.1 Setting Run Hours to Zero	17
2.6 Viewing Teamwork, Standby, and Cascade Status	18
2.6.1 To View the Teamwork Details	18
3 Service Operation	19
3.1 Editing Setpoints for the Cooling Unit	19
3.1.1 Setpoints Options	19
3.1.2 Configuring Temperature Setpoints	19
3.1.3 Temperature Control – Temperature Setpoints and Cooling Operation	21
3.1.4 Compressor Control by Cooling Requirement	23
3.1.5 Setting Temperature Compensation	27

- 3.1.6 Fan Temperature Compensation 28
- 3.1.7 Configuring High/Low Limit Setpoints 29
- 3.1.8 Configuring Fan Setpoints 30
- 3.1.9 Manual Fan Speed Control 31
- 3.1.10 Automatic Fan Speed Control 32
- 3.1.11 Configuring Static Pressure Setpoints 32
- 3.1.12 Supply Sensor Aggregation 34
- 3.2 Scheduling Condenser and Cooling Unit Tasks 35
 - 3.2.1 Scheduling Condenser Low-noise Operation 35
 - 3.2.2 Scheduling Condenser Fan Reversal 36
 - 3.2.3 Scheduling Sleep Times for Thermal Management Units 36
- 3.3 Setting General Thermal Management Unit Options 37
 - 3.3.1 Setting Miscellaneous Options 37
 - 3.3.2 Configuring Quick Start 39
 - 3.3.3 Automatic Restart after Power Failure 40
 - 3.3.4 Setting Fan Options 40
 - 3.3.5 Setting Compressor Options 42
 - 3.3.6 Setting Q15 Options 44
- 4 Managing Events: Alarms, Warnings and Messages 47**
 - 4.1 Event Properties 47
 - 4.1.1 To Open the Panel 47
 - 4.1.2 Alarms & Events Panel Fields 47
 - 4.2 Enabling Events and Editing Event Settings 48
 - 4.3 Selecting Event Type and Setting Alarm/Warning Notification 49
 - 4.3.1 To Select Event Type and Notification 49
 - 4.4 Enabling the Audible Alarm Notification 55
 - 4.5 Remote Alarm Device and Customer Input Events 55
 - 4.5.1 Setting Up Customer Input Events 56
- 5 Unit to Unit Networking 59**
 - 5.1 Preparing for U2U Group Set Up 59
 - 5.2 Configuring U2U Network Settings 61
 - 5.2.1 To Configure Unit to Unit Networking 61
 - 5.2.2 U2U Display and Control Board Settings 61
 - 5.2.3 Troubleshooting Network Settings Issues 63
 - 5.2.4 Modifying U2U Network Settings 63
- 6 Teamwork, Standby and Rotation for Cooling Units 65**
 - 6.1 Continuous Control with Virtual Master 65
 - 6.2 Teamwork Modes 65
 - 6.2.1 To Set Up Team Work 65
 - 6.2.2 No Teamwork—Multiple Zones in One Room 67
 - 6.2.3 Teamwork Mode 1—Parallel Operation 68

6.2.4	Teamwork Mode 2—Independent Operation	68
6.2.5	Teamwork Mode 3—Optimized Aisle Operation	68
6.3	Assigning Cooling Units to Standby (Lead/Lag)	69
6.3.1	To Set up Lead/Lag Operation	70
6.4	Setting a Rotation Schedule	70
6.4.1	Unit Rotation Options	71
6.4.2	Manually Rotating the Operating and Standby Units	71
7	Configuring Economizer Operation	73
7.1	Fluid Economizers	73
7.1.1	Fluid Economizer Control Options	73
7.1.2	Overriding Fluid Economizer Operation	74
7.1.3	Setting Up Fluid Economizer Operation	74
7.1.4	Temperature Control with a Fluid Economizer	76
7.1.5	Viewing Fluid Economizer Statuses	79
8	External Monitoring and Building Management Systems	81
8.1	BMS and Vertiv™ Liebert® IntelliSlot Settings	81
8.1.1	Configuring BMS Communication with Embedded Unity	81
8.1.2	Setting BMS Control Settings	82
8.1.3	Setting BMS Backup Setpoints	83
8.2	Communication Setup with Embedded Unity	83
8.2.1	Connecting to the BMS	84
8.2.2	Embedded Unity User and Password	88
8.2.3	Unity Restart and Restore Defaults	89
8.2.4	System Configuration	89
8.2.5	Local Users Configuration	90
8.2.6	Network Configuration	91
8.2.7	Web Server Configuration	93
8.2.8	Remote Services Configuration	96
8.2.9	Velocity Protocol Configuration	99
8.2.10	Messaging Configuration	100
8.2.11	BACnet Protocol Setup	105
8.2.12	Modbus Protocol Setup	108
8.2.13	SNMP Protocol Setup	110
8.3	Unity Status Readings	114
8.4	Unity Support Information	115
8.4.1	Configuring Active Networking Settings	116
9	Configuring Auxiliary Devices	119
9.1	Power Monitoring	119
9.1.1	To Set Up Power Monitoring	119
9.2	Fluid Temperature Monitoring	120
9.2.1	Fluid Sensor Options	120

- 9.3 Configuring Analog Input Devices121
- 9.4 Wired Remote Sensors 122
 - 9.4.1 Wired Remote Sensor—Set Up Options 122
 - 9.4.2 Wired Remote Sensor—Sensor Property Options 123
- 9.5 Supply Sensors 124
- 10 Administering Firmware, Settings and Security 125**
- 10.1 Vertiv™ Liebert® iCOM™ Firmware Upgrades125
 - 10.1.1 Compatibility with Earlier Versions of Vertiv™ Liebert® iCOM™ 125
 - 10.1.2 Updating Vertiv™ Liebert® iCOM™ Control Board Firmware 125
 - 10.1.3 Reverting to Firmware in Dormant Partition126
- 10.2 Backing Up and Restoring Control Board Settings 127
 - 10.2.1 Control Board Back Up and Restore Options127
- 10.3 Managing Access Permission and Passwords 128
- 11 Performing Diagnostics 129**
- 11.1 Cooling Unit Status LED 129
- 11.2 Enabling Manual Mode for Diagnostics 129
 - 11.2.1 Disabling Diagnostics Manual Mode 130
- 11.3 Diagnosing Evaporator Fan Issues 130
 - 11.3.1 Diagnostics—Evaporator Fan Options 130
- 11.4 Diagnosing Compressor Circuit Issues131
 - 11.4.1 Diagnostics—Compressor Circuit Options 131
 - 11.4.2 Resetting High Pressure Alarm Code 132
 - 11.4.3 Resetting Low Pressure Alarm Code 132
 - 11.4.4 Resetting High-temperature Alarm Counter 132
- 11.5 Diagnosing Electronic Expansion Valve Issues 132
 - 11.5.1 Diagnostics—Electronic Expansion Valve Options 133
 - 11.5.2 Resetting Electronic Expansive Valve Battery Failure Counter 134
- 11.6 Diagnosing EconoPhase Issues 134
 - 11.6.1 Diagnostics—EconoPhase Options 134
- 11.7 Diagnosing Digital Output Issues 135
 - 11.7.1 Diagnostics—Digital Output Options 135
- 11.8 Diagnosing Analog Output Issues 135
 - 11.8.1 Diagnostics—Analog Output Options 135
- 11.9 Diagnosing Customer Input Issues 136
 - 11.9.1 Diagnostics—Customer Input Options 136
- 12 Customizing Your Vertiv™ Liebert® iCOM™ Display 137**
- 12.1 Setting General Display Properties 137
 - 12.1.1 Unit Display Options 137
- 12.2 Customizing Main Display Views 138
 - 12.2.1 Moving Content 138
 - 12.2.2 Resizing Content 138

12.2.3	Adding and Adjusting Content	139
12.2.4	Removing Content	140
12.3	Customizing Parameter and Field Labels	140
12.3.1	Exporting, Importing, and Customizing Labels Using a Text Editor	142
13	Hardware Installation	145
13.1	Installing Wired Remote Sensors	145
13.1.1	Setting DIP Switches and Labeling 2T Sensors	145
13.1.2	Terminating the Last Sensor on the CANbus Link	147
13.1.3	Installing 2T Sensors in the Racks to Monitor	150
13.1.4	Connect the CANbus Cable and Ground	152
13.2	Installing a Fluid Temperature Sensor	154
13.3	Installing Supply Control Sensors	156
13.3.1	Installing the Supply Air Temperature Sensor	156
13.3.2	Installing Aggregated Supply Air Temperature Sensors	157
13.4	Installing Analog Input Devices	160
13.5	Installing the Unit to Unit Network	161
13.5.1	Required Network Equipment	161
13.5.2	Planning Wiring Runs	161
13.5.3	U2U Wiring Connection	162
13.5.4	Wiring Cooling Units without Wall Mount Displays	163
13.5.5	Wiring Cooling Units with Wall Mount Displays	165
Appendices	167
Appendix A:	Technical Support and Contacts	167
Appendix B:	Setpoints and Alarm Settings by Line ID	169

This page intentionally left blank

1 Getting Started with Vertiv™ Liebert® iCOM™

The Liebert® iCOM™ offers the highest capability for unit control, communication, and monitoring of Liebert Thermal Management units. It is available factory installed on new units and assemblies or may be retrofitted in existing units.

NOTE: Your Vertiv™ Liebert® DSE Packaged Solution does not offer humidification or dehumidification functions. Please disregard those settings/fields when mentioned in this guide or displayed on the Liebert® iCOM™ controller.

1.1 Touchscreen Display and User Interface

The Vertiv™ Liebert® iCOM™ touchscreen and user interface speeds set up and installation and simplifies control of Liebert Thermal Management units, literally putting cooling-system monitoring and management at your fingertips.

- The capacitive touchscreen is used with a firm touch, or consider using a stylus when interacting with the touchscreen.
- User and service menus are password protected to prevent unauthorized changes to cooling-unit operation.
- The touchscreen is back-lit and auto-dims after a period on non-use, then turns off. Touch the screen to illuminate the main screen.
- Liebert® iCOM™ ships with default settings for efficient and effective operation of most cooling-units and is easily configured to meet any need.
- Liebert® iCOM™ menus and displays are based on the options installed on the cooling units that it monitors and manages.

Figure 1.1 Vertiv™ Liebert® iCOM™ Main Display

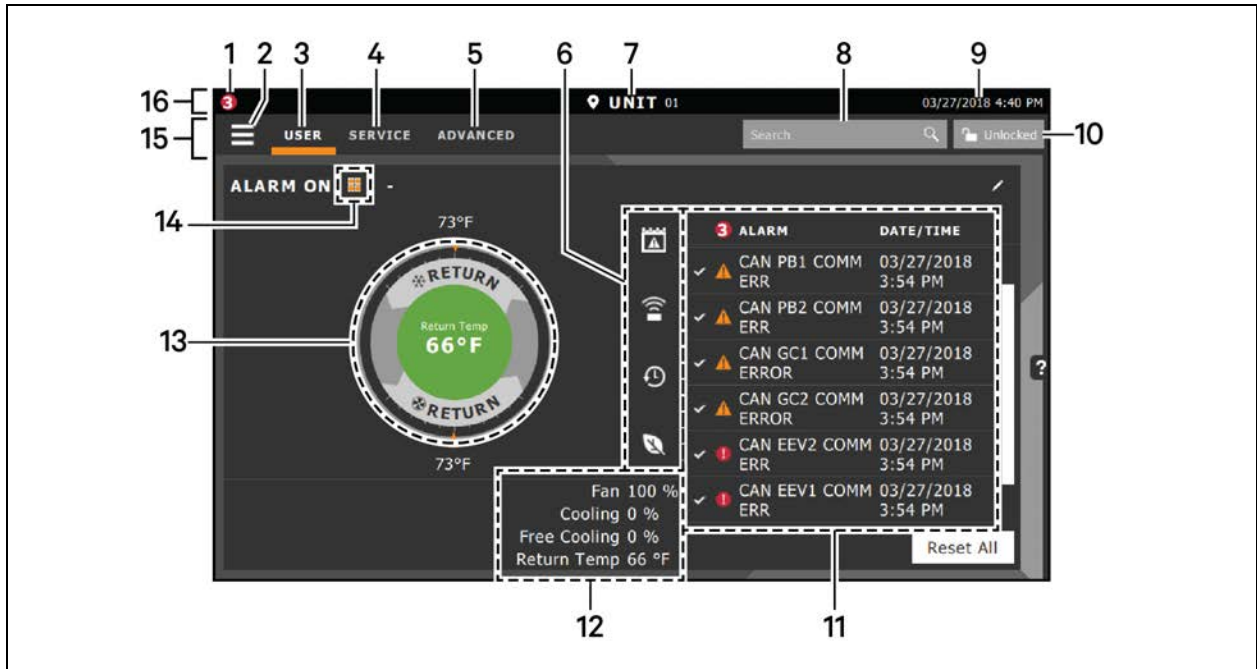

Table 1.1 Main Display Controls and Options

Item	Description
1	Alarms present. Displays the number of active alarms.
2	Menu icon. When unlocked, displays a menu for user or service options depending on which icon is selected.
3	User icon. When selected, the user options are available on the main display and menu. NOTE: You must unlock the display with the User PIN to access the menu and options. See Powering On Vertiv™ Liebert® iCOM™ and Logging In/Unlocking Controls on page 6 .
4	Service icon. When selected, the service options are available on the main display and menu. NOTE: You must unlock the display with the Service PIN to access the menu and options. See Powering On Vertiv™ Liebert® iCOM™ and Logging In/Unlocking Controls on page 6 .
5	Advanced icon. When selected, the advanced options are available on the main display and menu. NOTE: You must unlock the display with the Service PIN to access the menu and read-only options. See Powering On Vertiv™ Liebert® iCOM™ and Logging In/Unlocking Controls on page 6 .
6	Cooling-unit parameters. Status display of selected system parameter settings. See Adding and Adjusting Content on page 139
7	Unit Identification. You may customize the unit name up to 6 characters/numbers.
8	Search icon. Open the keyboard to search for controls and setting locations. See Searching on page 9 .
9	Date/Time.
10	Lock/Unlock icon. Indicates whether or not the user and service options are accessible. <ul style="list-style-type: none"> Locked icon: Display is read-only Unlocked icon: User or service is logged-in and options are accessible. See Powering On Vertiv™ Liebert® iCOM™ and Logging In/Unlocking Controls on page 6 .
11	Secondary-content panel. When accessing settings/configuration via the menus, the settings display in the right, secondary panel.

Table 1.1 Main Display Controls and Options (continued)

Item	Description
12	Summary of current unit function. You can customize to show fan speed, cooling, percentages from any installed device, and any physical (sensor) values.
13	Status Dial. Circular display of setpoints and environmental conditions of the unit. See Touchscreen Status Dial below .
14	Teamwork-mode icon. In a panel with Status content, the Teamwork Mode icon indicates the mode selected. For details and descriptions of the teamwork controls, see Teamwork Modes on page 65 .
15	Control header. Controls to access the user and service menus. See Control Header on page 6 .
16	Status Header. Displays the alarm status, unit identification, and the current date and time.

1.2 Touchscreen Status Dial

The dial in the primary control panel displays read-only control sensors, setpoints, and environmental conditions for unit status at a glance. See [Figure 1.2](#) on the next page .

The center of the dial displays sensor readings and changes color according to alarm thresholds as the readings rise and fall, see [Dial Background Color Status Indication](#) on page 5 .

Touching the center of the dial cycles through a set of sensor settings, and you can select the readings displayed, see [Adding and Adjusting Content](#) on page 139 .

Figure 1.2 Dial Sections

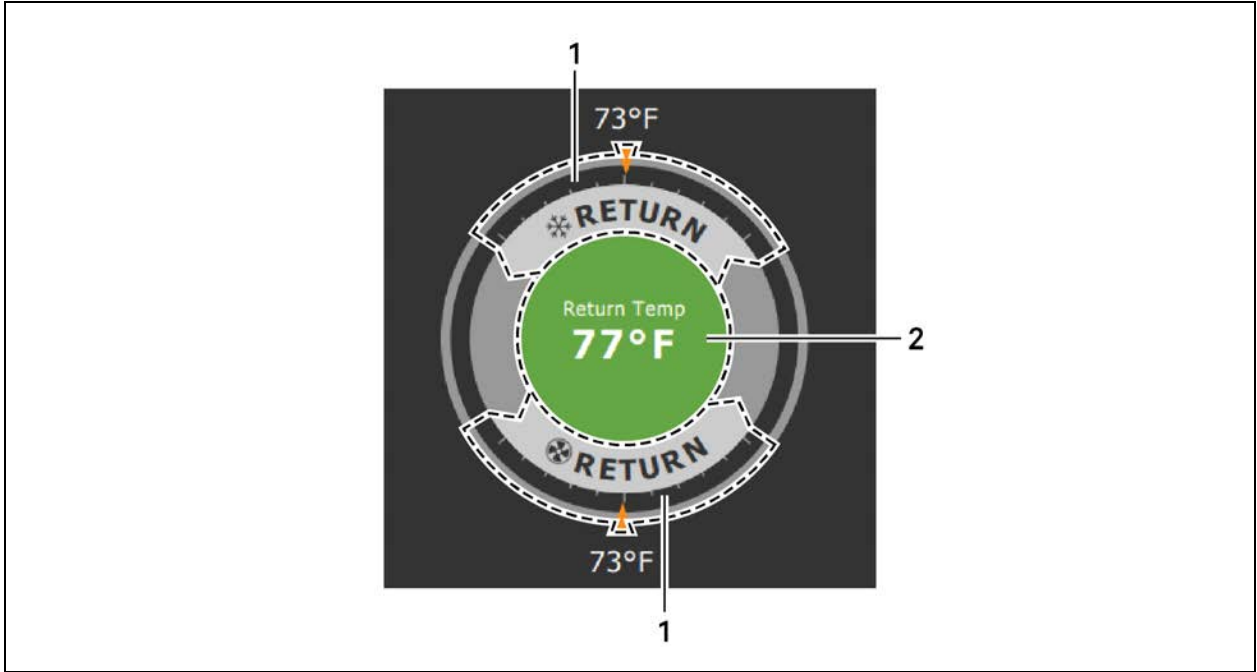

Table 1.2 Dial Sections

Item	Description
1	Control sensor and its setpoint. The sensors and setpoints displayed depend on the configuration of your unit. You may see only temperature-control, or if the unit includes humidity control, that displays on the dial as well. If the sensor selected for fan control is the same as that selected for temperature control, the dial displays the fan-control sensor and setpoint, as shown in Figure 1.2 above.
2	Single or multiple sensor readings. Cycle through readings by touching the displayed reading.

1.2.1 Dial Background Color Status Indication

The background color of the dial indicates whether or not the unit is powered on, and it also responds to threshold settings of the control-sensor reading, see **Figure 1.3** below. **Table 1.3** below describes the background color displayed if the selected sensor reading has threshold limits set.

Figure 1.3 Dial Background Colors

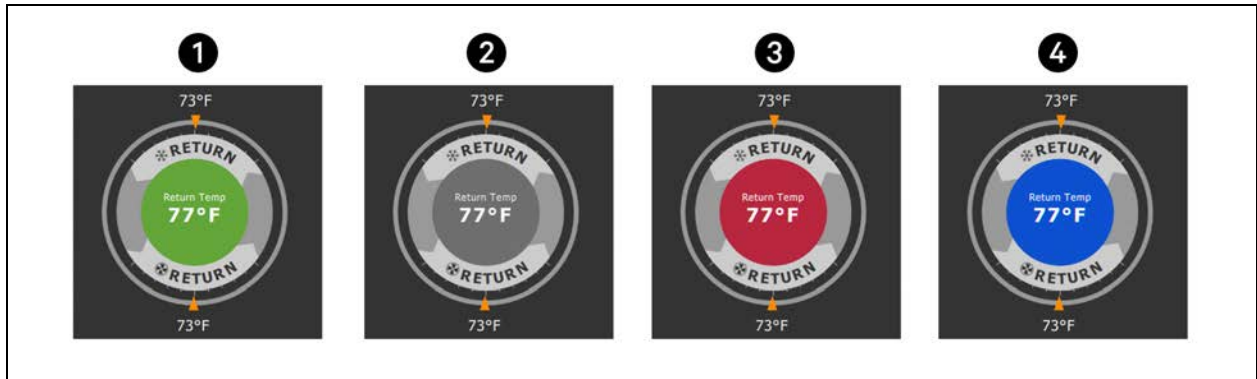

Item	Description
1	Sensor reading is within threshold limits.
2	Unit is powered off.
3	Sensor reading is above threshold limit or the unit is in an alarm condition.
4	Sensor reading is below threshold limit

Table 1.3 Background Color Displayed by Selected Value and Threshold Limit

Sensor/Value Selected	Threshold Limit	Background Color
Return Temp	None	Blue
	High return temperature	Red
Return Humidity	Low return humidity	Blue
	High return humidity	Red
Dew Point	Low dew point	Blue
	High dew point	Red
Supply Temp	Low supply temperature	Blue
	High supply temperature	Red
Average Rack Temp	Low remote temperature	Blue
	High remote temperature	Red
Max Rack Temp	Low remote temperature	Blue
	High remote temperature	Red

Table 1.3 Background Color Displayed by Selected Value and Threshold Limit (continued)

Sensor/Value Selected	Threshold Limit	Background Color
Min Rack Temp	Low remote temperature	Blue
	High remote temperature	Red
Static Pressure	Low static pressure	Blue
	High static pressure	Red
Outdoor Temp	None	Green
Outdoor Humidity	None	Green

1.3 Control Header

The control header contains the controls to access the user and service settings. The display is locked when started initially and when restarted after a period of inactivity.

1.3.1 Powering On Vertiv™ Liebert® iCOM™ and Logging In/Unlocking Controls

Liebert® iCOM™ is powered on when power is switched on at the cooling unit’s disconnect switch and you activate the display by touching it.



Liebert® iCOM™ is locked when started and also locks after a period of inactivity to prevent unauthorized changes. A four digit password is required to access the user and service menus and options, and the advance menu displays as read only when logged in at the service level.

NOTE: The factory default inactivity period is one minute. To change the inactivity period, see [Setting General Display Properties](#) on page 137 .

NOTE: The factory-default password for user and service login are provided. We recommend you change passwords as necessary to prevent unauthorized changes. See [Managing Access Permission and Passwords](#).

- Default User password: 1490
- Default Service password: 5010

To unlock the controls:

1. On the header, touch . The keypad opens.
2. Touch the numbers/characters for your password, then touch .
Depending on the password entered and your level of access, the User and/or Service options, and view only access to the Advanced menu are accessible. See [Accessing the User, Service, and Advanced Menus](#) on page 10

1.3.2 Powering On the Thermal Management Unit

NOTE: Depending on the operating state, there are start/stop priority switches that may prevent the cooling unit from operating even though power to the unit is switched on and you have turned it on via Vertiv™ Liebert® iCOM™.

The cooling unit operates only when all switches are closed. For example, even though you have turned on the unit through Liebert® iCOM™, if the BMS remote monitoring system is sending a command to turn off the unit, the cooling unit remains off.

NOTE: You must be logged in to access the menu options. See [Powering On Vertiv™ Liebert® iCOM™ and Logging In/Unlocking Controls](#) on the previous page .

To power-on the unit:



1. Touch , then  > Turn Unit On. The TURN UNIT ON dialog opens.
2. Touch Turn Unit On. The cooling unit starts and the operating status is displayed as shown in [Figure 1.4](#) below .

Figure 1.4 Unit Status on Liebert® iCOM™ Display



Item	Description
1	Current status of the unit. See Table 1.4 below .
2	Teamwork icon. See Viewing Teamwork, Standby, and Cascade Status on page 18 .

Table 1.4 Cooling Unit Statuses Displayed

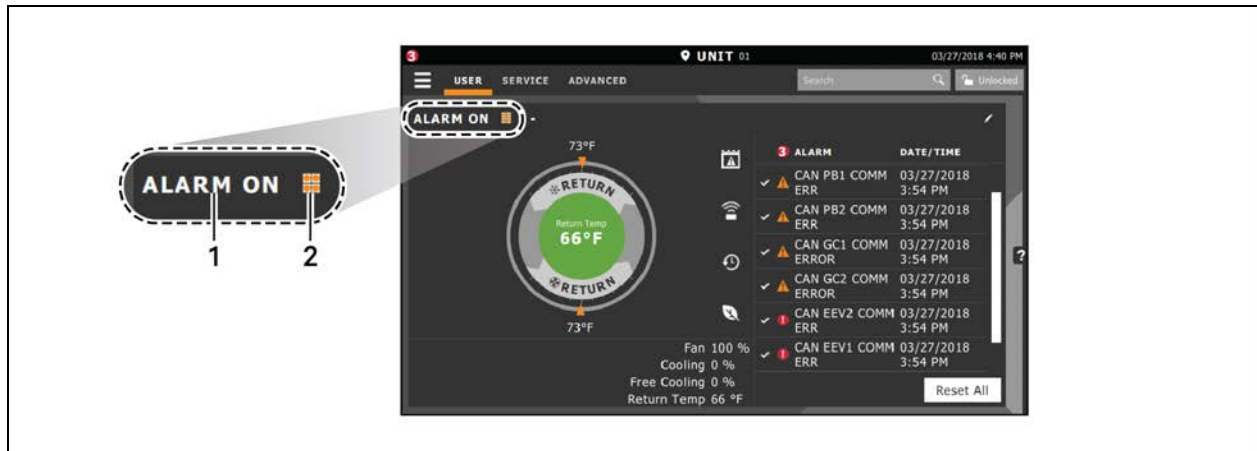

Unit Status Text	Description
ALARM OFF	An alarm forced the unit to turn off. See Viewing Unit Alarms on page 14 .
MANUAL	Controlled by a service technician. See Enabling Manual Mode for Diagnostics on page 129 .
DISPLAY OFF	Unit is turned Off at the Liebert® iCOM™ display. See Powering On the Thermal Management Unit above .
ALARM STANDBY	In stand-by because of an active alarm on the unit. See Viewing Unit Alarms on page 14 .

Table 1.4 Cooling Unit Statuses Displayed (continued)

Unit Status Text	Description
STANDBY	In standby because of service-menu setting. See Assigning Cooling Units to Standby (Lead/Lag) on page 69 .
TIMER OFF	Scheduled on a timer and is in “sleep” mode waiting for the next start interval. See Scheduling Condenser and Cooling Unit Tasks on page 35 .
UNIT ON	Operating normally without alarms or warnings.
WARNING ON	Active warning, but still operating. See Viewing Unit Alarms on page 14 .
ALARM ON	Active alarm, but still operating. See Viewing Unit Alarms on page 14 .
TIMER	Scheduled on a timer to operate, and is in operating mode. See Scheduling Condenser and Cooling Unit Tasks on page 35 .
REMOTE OFF	Turned-off by remote shutdown terminal. Occurs when a normally-closed set of 24V contacts opens. The Remote On/Off and Display On/Off switches are in series, and the cooling unit will only turn-on if both switches are on/closed. If one is off/open, the unit turns off.
MONITORING OFF	Turned-off by remote monitoring system. Check the remote monitoring device or call Vertiv™ technical support for assistance.
BACK-DRAFT	Unit is non-operational, but EC fan is operating as a back draft damper.
RESTART DELAY	Not yet operational after a power cycle because the restart-delay timer is active.

1.3.3 Powering Off the Thermal Management Unit

NOTE: You must be logged in to access the menu options. See [Powering On Vertiv™ Liebert® iCOM™ and Logging In/Unlocking Controls](#) on page 6 .

1. Touch , then  > *Turn Unit Off*. The TURN UNIT OFF panel opens.
2. Touch *Turn Unit Off*. The unit begins a power-off countdown then powers off.

1.3.4 Logging Out

Log out occurs automatically when the display back light turns off for inactivity.

NOTE: The factory default inactivity period is one minute. To change the inactivity period, see [Setting General Display Properties](#) on page 137 .

- To log-out manually, touch the lock icon. The icon indicates “locked.”

1.3.5 Calibrating the Touchscreen



Use a firm touch or a stylus for the best response. To improve interaction with quicker and more accurate touch response, calibrate the touchscreen.

1. On the User menu, touch *Display Options* > *Display Properties*.
2. On the UNIT DISPLAY panel, touch *Calibrate Screen* and follow the prompts to calibrate.
 - If you cannot access the calibration because of screen response, continue with step 3 .
3. At the cooling unit disconnect switch, power off the unit and then back on.
4. Touch your finger to the screen and hold it there while the display boots.

5. When the LED begins flashing, remove your finger. Cross hairs appear in each corner and in the center of the display.
6. Touch the center of each cross hair ONCE ONLY. (Touching more than once interrupts the calibration and you must start over at step 3.)
Cross hairs disappear and the display reboots when calibration is complete.

1.3.6 Setting the Date and Time

The correct date and time is critical for warnings, alarms, and scheduling.

1. Touch , then  > *Display Options* > *Display Properties* > *Date & Time*.
2. Touch the date field, use the arrows to select the date, and touch *OK*.
– or –
Touch the time field, use the arrows to set the time, and touch *OK*.
3. Select the date and time format if necessary.
4. Touch *Save*.

1.3.7 Searching

When logged in, you can use the display search to find the location of settings options based on a term, service code, or parameter. You can also search by the line ID used in the Vertiv™ Liebert® iCOM™ before the touchscreen model. For a listing of the line IDs, see [Setpoints and Alarm Settings by Line ID](#) on page 169 .

NOTE: You must be logged in to access the display search. See [Powering On Vertiv™ Liebert® iCOM™ and Logging In/Unlocking Controls](#) on page 6 .

1. In the control header, touch the search field. The keyboard opens.
2. Type the term and touch . A list of locations that contain the searched term opens.
3. To go to a listed location, touch an item, then touch *Go*. The panel for the selected location opens.
– or –

To view the service codes and parameter entries related to the searched term, touch *View Parameter Directory Entries* (the number of related entries is included in the option).

The Parameter Directory opens. You may further refine the search in the directory.

1.4 Using Context Sensitive Help

Touching the Help icon, , on the right-hand side of the display opens the Help drawer with information about the panel or dialog currently on the display.

You can use search and the topic index to find further information.

To close the Help drawer, touch the close arrow, .

1.5 About Vertiv™ Liebert® iCOM™ Version





The version, build, and other firmware information for the Liebert® iCOM™ display board may be helpful when servicing or troubleshooting. To locate the firmware version of the Liebert® iCOM™ control board, see [Updating iCOM Control Board Firmware](#).

- Touch , then  > *About*. The ABOUT panel opens.

1.6 Accessing the User, Service, and Advanced Menus

Vertiv™ Liebert® iCOM™ operating functions that monitor and control a cooling unit are accessed via the User and Service menus.

NOTE: You must be logged in to access the menu options. See [Powering On Vertiv™ Liebert® iCOM™ and Logging In/Unlocking Controls](#) on page 6 .

1. To access a menu, touch the icon for the menu you want, , , or , in the control header, see [Control Header](#) on page 6 . The orange bar appears below the menu name when selected indicating that this is the menu content that will be displayed.
2. Touch the menu icon, . The menu opens.

1.7 User Menu

The user menu lets you view system and unit statuses and edit some setpoints.

1.7.1 User menu options

Setpoints

Opens the SETPOINTS panel. See [Viewing and Editing Setpoints for the Cooling Unit](#) on page 13 .

Active Alarms

Opens the ALARMS panel. See [Viewing Unit Alarms](#) on page 14 .

Event Log

Opens the EVENT LOG panel. See [Viewing the Event Log](#) on page 16 .

Sensor Data

Opens the SENSOR DATA panel. See [Viewing Sensor Data](#) on page 17 .

Display Options

Opens the Display Options menu:

- Customize Layout: See [Customizing Main Display Views](#) on page 138 .
- Custom Labels: See [Customizing Parameter and Field Labels](#) on page 140 .
- Date & Time: See [Setting the Date and Time](#) on page 9 .

Total Run Hours

Opens the RUN HOURS panel. See [Managing Run Hours for a Component](#) on page 17 .

EconoPhase

Opens the ECONOPHASE - PUMP MODE panel.

About

Opens the ABOUT panel. See [About Vertiv™ Liebert® iCOM™ Version](#) on the previous page .

Turn Unit On/Off

Depending on unit's status, open the TURN UNIT ON or TURN UNIT OFF dialog. See [Powering On the Thermal Management Unit](#) on page 7 , or [Powering Off the Thermal Management Unit](#) on page 8 .

1.8 Service Menu

The service menu lets you view and edit setpoints and perform many other functions.

1.8.1 Service Menu Options

Setpoints

Opens the SETPOINTS panel. See [Editing Setpoints for the Cooling Unit](#) on page 19 .

Diagnostic/Service

Opens the Diagnostic/Service menu:

- Diagnostics: See [Performing Diagnostics](#) on page 129 .
- EconoPhase View: Opens the ECONOPHASE - PUMP MODE panel.
- Technical Support: Contact information for the cooling unit and Vertiv™ Liebert® iCOM™ display.

Alarm/Event Setup

Opens the ALARMS & EVENTS panel. See [Managing Events: Alarms, Warnings and Messages](#) on page 47 .

BMS & Teamwork

Opens the BMS & Teamwork menu:

- U2U Setup—See [Configuring U2U Network Settings](#) on page 61.
- Teamwork/Standby—See [Teamwork, Standby and Rotation for Cooling Units](#) on page 65.
- BMS Setup—See [BMS and IntelliSlot Settings](#).

Scheduler

Opens the SCHEDULER panel. See [Scheduling Condenser and Cooling Unit Tasks](#) on page 35.

Options Setup

Opens the OPTIONS SETUP panel. See [Setting General Thermal Management Unit Options](#) on page 37.

Auxiliary Device Setup

Opens the Auxiliary Device Setup menu:

- Sensors: See [Wired Remote Sensors](#) on page 122.
- Analog Input: See [Configuring Analog Input Devices](#) on page 121.
- Modbus Devices
- CapCom

Backup & Security

Opens the Backup & Security menu:

- Display Backup and Restore: See [Backing Up, Importing, Exporting, and Restoring Display Settings](#).
- Control Backup and Restore: See [Backing Up and Restoring Control Board Settings](#).
- Display Upgrade: See [Updating iCOM Display Firmware](#).
- Control Upgrade: See [Updating iCOM Control Board Firmware](#).
- Manage Permissions: See [Managing Access Permission and Passwords](#).

Turn Unit On/Off

Depending on unit's status, open the TURN UNIT ON or TURN UNIT OFF dialog. See [Powering On the Thermal Management Unit](#) on page 7, or [Powering Off the Thermal Management Unit](#) on page 8.

2 User Operation



2.1 Viewing and Editing Setpoints for the Cooling Unit

NOTE: User level access allows viewing and editing only a limited number of setpoints. To view or adjust all setpoints, you must have service level access. See [Editing Setpoints for the Cooling Unit](#) on page 19 .

NOTE: Depending on the type of thermal management unit, included components, and control settings of your system, the options on your Vertiv™ Liebert® iCOM™ display may differ.

NOTE: Your Vertiv™ Liebert® DSE Packaged Solution does not offer humidification or dehumidification functions. Please disregard those settings/fields when mentioned in this guide or displayed on the Liebert® iCOM™ controller.

2.1.1 Editing Temperature Setpoints

1. Touch , then  > *Setpoints* > *Temperature Control*. The TEMPERATURE CONTROL secondary panel opens.
2. Refer to [User Temperature Setpoint Options](#) below , [Temperature Control – Temperature Setpoints and Cooling Operation](#) on page 21 , and [Compressor Control by Cooling Requirement](#) on page 23 to adjust the setpoint options, then touch *Save*. The setpoint is updated.
 - Touch *Cancel* to discard the changes.

NOTE: Depending on the type of thermal management unit, included components, and control settings of your system, all of the options listed may not be available on your Vertiv™ Liebert® iCOM™ display.

User Temperature Setpoint Options

BMS Backup Temp Setpoint

Selects a temperature setpoint that activates in the event of a BMS timeout. The BMS timer must be configured for this setpoint to activate. See [Setting BMS Backup Setpoints](#).

Optimized Aisle Enabled

Read-only. Indicates that Vertiv™ Liebert® iCOM™ is configured for optimized aisle operation. See [Teamwork Mode 3—Optimized Aisle Operation](#) on page 68 .

Temperature Control Sensor

Selects sensor that controls cooling. Values are:

- Supply Sensor: Temperature control is based on maintaining the temperature of the discharge air from the cooling unit. See [Supply Sensors](#) on page 124 .
- Remote Sensor: Temperature control is based on the temperature reading(s) from wired remote sensor(s). See [Wired Remote Sensors](#) on page 122 .
- Return Sensor: Temperature control is based on maintaining the temperature of the air returning to the cooling unit.

Temperature Setpoint Act

Read-only display of adjusted temperature setpoint when one of the following is active:

- Temperature compensation
- BMS back up temperature setpoint
- Customer input setpoint (remote alarm device)

Temperature Setpoint

Temperature that the unit maintains via cooling/reheat.

2.2 Viewing Unit Alarms

The ALARMS panel lists active alarm and warning events. **Table 2.1** below describes the type and state of the alarm shown by indicator dots.

Table 2.1 Alarm Status/Type Indicators

Indicator	Description
Yellow dot	Warning event.
Red dot	Alarm event.
Circle	Event condition has cleared, but still must be acknowledged. See Acknowledging Alarms on the facing page .

2.2.1 To View Alarms

1. Touch , then  > *Alarms*. The ALARMS panel opens.
2. Touch an alarm to display the ALARM DETAILS panel.

Alarm fields

Alarm

Name of the event.

Date

Date event was logged.

Time

Time event was logged

Alarm Detail Fields

Alarm

Name of the event.

Alarm Type

Number representing the event type.

- 1: Warning
- 2: Alarm

Date/Time

Date and time the event was logged.

Duration

Time elapsed since event was logged.

Threshold

Sensor reading at which an event is triggered.

Unit

Cooling unit to which the alarm applies.

Value

The current value to which the threshold is compared.

2.2.2 Silencing an Audible Alarm

Touch the screen to silence an audible alarm. If the alarm is non-latching, the alarm silences when the condition clears.

NOTE: The audible alarm must be enabled in display options to sound. See [Enabling the Audible Alarm Notification](#) on page 55 .

2.2.3 Acknowledging Alarms

Depending on the notification settings, alarms and warnings must be acknowledged or reset. An event is active as long as it is unacknowledged, with the exception of the network failure events described in **Table 22** on the next page . Once acknowledged, an event remains active until the situation that triggered the event is resolved, see **Table 21** on the previous page , for event status indicators. When an event acknowledged and cleared, it is removed from the Alarms panel and the LED stops flashing red.

NOTE: Acknowledging alarm events does not clear them. To clear an issue, it must be corrected, reset automatically by the controller, or reset manually.

To Acknowledge Alarms

1. On the ALARMS panel, touch *Acknowledge All*. A check mark overlays the status indicator of the active alarms and warnings, and these automatically clear when the condition is no longer present.
 - If a critical event must be manually reset, the acknowledged items are listed with a Reset All button on the ALARMS panel.
2. Touch *Reset All* to manually reset the condition.

Table 2.2 Events That Clear without Acknowledgment

Network Failure	Description
UNIT XX DISCONNECTED	The Vertiv™ Liebert® iCOM™ I/O board assigned as U2U address number XX (two up to thirty-two) has lost communication with the group. Make sure all units are powered-on at the disconnect. Check cable connections and network settings where applicable.
NO CONNECTION W/UNIT 1	The Liebert® iCOM™ I/O board assigned as U2U address number 1 has lost communication with the group. Make sure all units are power on at the disconnect. Check cable connections and network settings where applicable.
BMS DISCONNECT	The BMS/BAS has not completed a handshake within the time defined by the BMS/BAS. Verify monitoring connections and communication to the BMS/BAS panel.
UNIT CODE MISSING	The factory unit code must be confirmed, saved and executed.
UNIT CODE MISMATCH	The factory unit code must be confirmed, saved and executed.
CAN GC 1 or 2 COMM ERR	See Events Specific to Liebert® MC Condenser on page 52 .
CAN PB COMM ERR	See Events Specific to Liebert® EconoPhase on page 53 .

2.3 Viewing the Event Log

The event log is a list by date/time of the last 400 events generated by Vertiv™ Liebert® iCOM™ for the Thermal Management unit.

- On the User menu, touch *Event Log*. The EVENT LOG for the cooling unit opens. **Table 2.3** below describes the color coded status for each event.



NOTE: Depending on the type of thermal management unit, included components, and control settings of your system, the options on your Liebert® iCOM display may differ.

Table 2.3 Event Status/Type Indicators

Indicator	Description
Green dot	Message.
Yellow dot	Unacknowledged warning event. See Acknowledging Alarms on the previous page .
Red dot	Unacknowledged alarm event. See Acknowledging Alarms on the previous page .
White dot with check mark overlay	Acknowledged event, the cause still exists.
White circle	Acknowledged event, the cause is cleared.

2.4 Viewing Sensor Data

The Sensor Data panel lists the standard and optional sensors monitored by Vertiv™ Liebert® iCOM™ and the current reading of each sensor.



- Touch , then  > *Sensor Data*. The SENSOR DATA panel opens.

A secondary panel displays the DAILY SENSOR READING SUMMARY, which shows temperature, humidity and dew point readings for the cooling unit.

NOTE: Depending on the type of thermal management unit, included components, and control settings of your system, the options on your Liebert® iCOM™ display may differ.

2.5 Managing Run Hours for a Component

You can view the run hours for components on a cooling unit, set the total run time limit, and reset total run hours to zero.

1. Touch , then  > *Total Run Hours*. The RUN HOURS panel opens and the current hours for each component are listed in the Total Run Hours column. To reset the total run hours to zero, see [Setting Run Hours to Zero](#) below .
2. Use the slider to set the total run time limit for each component, then touch *Save*. The limits are set.

NOTE: Depending on the type of thermal management unit, included components, and control settings of your system, the options on your Vertiv™ Liebert® iCOM™ display may differ.

2.5.1 Setting Run Hours to Zero

1. On the RUN HOURS panel, touch to check each box in the *Total Run Hours* column next to the component(s) to reset. The Set to Zero button becomes available.
2. Touch *Set to Zero*. The total run hours for selected component(s) is set to zero.

2.6 Viewing Teamwork, Standby, and Cascade Status

In the main User panel, the Teamwork mode icon indicates the mode selected, **Figure 2.1** below .

2.6.1 To View the Teamwork Details

Touch the Teamwork mode icon.

The Teamwork dialog opens displaying the Teamwork mode, number of units in standby, and number of operating units.

NOTE: You must be logged in with the Service PIN to edit teamwork mode. See [Powering On Vertiv™ Liebert® iCOM™ and Logging In/Unlocking Controls](#) on page 6 .

Figure 2.1 Teamwork Icons

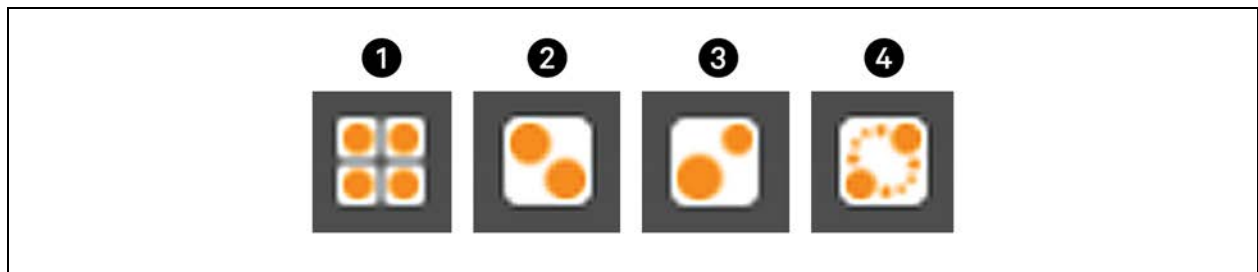

Item	Description
1	No teamwork.
2	Mode 1 - Parallel teamwork
3	Mode 2 - Independent teamwork
4	Mode 3 - Optimized aisle teamwork

3 Service Operation

NOTE: Your Vertiv™ Liebert® DSE Packaged Solution does not offer humidification or dehumidification functions. Please disregard those settings/fields when mentioned in this guide or displayed on the Vertiv™ Liebert® iCOM™ controller.

3.1 Editing Setpoints for the Cooling Unit

Setpoints are the means by which cooling unit operation is controlled.

NOTE: Depending on the type of thermal management unit, included components, and control settings of your system, all of the options listed may not be available on your Vertiv™ Liebert® iCOM™ display.

3.1.1 Setpoints Options

Fan Control

See [Configuring Fan Setpoints](#) on page 30 .

High/Low Limit Control

See [Configuring High/Low Limit Setpoints](#) on page 29 .



Temperature Control

See [Configuring Temperature Setpoints](#) below .

Temperature Compensation

See [Setting Temperature Compensation](#) on page 27 .

3.1.2 Configuring Temperature Setpoints

1. Touch , then  > *Setpoints* > *Temperature Control*. The TEMPERATURE CONTROL secondary panel opens.
2. Refer to [Temperature Control Options](#) on the next page , [Temperature Control – Temperature Setpoints and Cooling Operation](#) on page 21 , and [Compressor Control by Cooling Requirement](#) on page 23 ” to adjust the setpoint options, then touch Save. The setpoint is updated.

NOTE: Proportional band setting is dependent on the heat load and the components specific to your cooling unit. Additional tuning may be required after start-up when using PI temperature control. See [Considerations when Using PI Temperature Control](#) on page 23 .

NOTE: Depending on the type of thermal management unit, included components, and control settings of your system, all of the options listed may not be available on your Vertiv™ Liebert® iCOM™ display.

Temperature Control Options

AutoSet Enabled

When enabled, the proportional band for temperature and humidity and both integration time factors are set automatically based on the type of cooling unit (single compressor, dual compressor or chilled water).

NOTE: General settings cannot be adjusted or changed when AutoSet is enabled. If you make a change when AutoSet is enabled, the parameter defaults back to its original setting.

BMS Backup Temp Setpoint

Temperature that the cooling unit maintains during BMS backup operation.

Temperature Control Sensor

Selects sensor that controls cooling. Values are:

- Supply Sensor: Temperature control is based on maintaining the temperature of the discharge air from the cooling unit. See [Supply Sensors](#) on page 124 .
- Remote Sensor: Temperature control is based on the temperature reading(s) from wired remote/rack sensor(s). See [Wired Remote Sensors](#) on page 122 .
- Return Sensor: Temperature control is based on maintaining the temperature of the room air.
- Customer input setpoint (remote alarm device).

Temperature Control Type

Control when staging cooling and heating operations. Valid values:

- Proportional: Percent of cooling/heating determined by the difference between the air temperature sensor reading and the temperature setpoint.
- PI: Percent of cooling/heating calculated using the temperature proportional band and temperature integration time settings. See [Considerations when Using PI Temperature Control](#) on page 23 .
- Adaptive PID: Auto-tuning PID control loop, can be set for cooling. Only available on Vertiv™ Liebert® CW (chilled water) systems.
- Intelligent: Percent of cooling/heating determined by programmed logic that simulates manual human control.

Temperature Deadband

Widens the setpoint to prevent small temperature changes from cycling compressors and valves maximizing component life. When temperature is within the deadband, no change of the control output (heating/cooling) occurs.

Temperature Integration Time

Adjusts amount of cooling/heating based on the length of time the temperature has deviated from the setpoint. The time selected is the amount of time it will take cooling capacity to reach 100%. For example, if three minutes is selected, cooling capacity will increase to 100% in three minutes.

NOTE: Three to five minutes of integration time is adequate for most applications. See [Considerations when Using PI Temperature Control](#) on page 23 .

NOTE: Only used when Temperature Control Type is PI.

Temperature Proportional Band

Adjusts the activation point of cooling components based on deviation from setpoint by placing half of the selected value on each side of the temperature control setpoint. A smaller number causes faster reaction to temperature changes.

NOTE: Setting this too low causes short cycling of compressors.

Temperature Setpoint

Temperature that the unit maintains via cooling.

Temperature Setpoint Act

Read-only display of adjusted temperature setpoint when one of the following is active:

- Temperature compensation
- BMS backup temperature setpoint

3.1.3 Temperature Control – Temperature Setpoints and Cooling Operation

Temperature control refers to the cooling unit's response to programmed setpoints and sensed room/load conditions. Temperature control is closely tied to the primary cooling source. Liebert Thermal Management units employ several types of primary cooling sources:

Compressor Operation

Vertiv™ Liebert® iCOM™ controls the cooling units based on a calculated need for cooling (and heating, if included on your system). The requirement is expressed as a percentage and is calculated using the selected temperature control type.

Temperature Proportional Band

Use the proportional and dead band parameters to control how your cooling unit(s) respond based on the calculated need for cooling (or heating). **Figure 3.1** on the next page, illustrates temperature control using:

- 70° setpoint
- 10° proportional band
- No deadband

The proportional band is divided evenly on each side of the setpoint.

- 0% cooling capacity is required at 70°.
- As the air temperature increases, cooling also increases along the proportional band.
- If the air temperature reaches 75°, the system operates at cooling capacity.
- If air temperature rises to the end of the proportional band or further, the system operates at 100% capacity to bring the temperature down to the setpoint.

Figure 3.1 Temperature Control without a Deadband

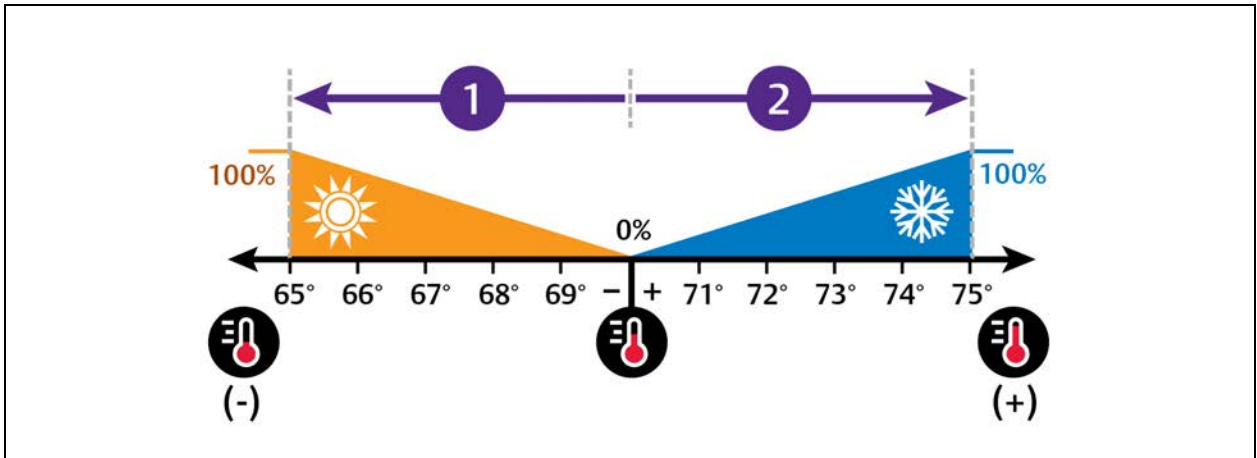

No.	Description
1	½ of proportional band.
2	½ of proportional band.

Temperature Deadband

A deadband widens the setpoint to prevent small temperature changes from activating compressors and valves and causing excessive component cycling. **Figure 3.2** on the facing page, illustrates temperature control using:

- 70° setpoint
- 10° proportional band
- 2° deadband

Like the proportional band, the deadband is also divided evenly on each side of the setpoint.

- 0% cooling capacity is required from 69° to 71°.
- At 71°, the system operates according to the temperature proportional band.

Figure 3.2 Temperature Control with a Deadband

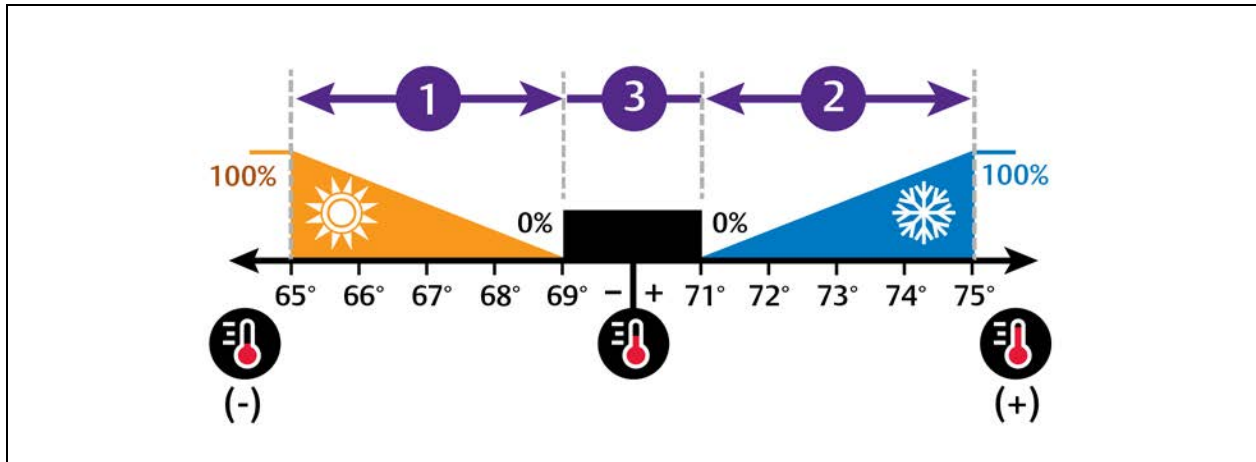

No.	Description
1	½ of proportional band.
2	½ of proportional band.
3	Deadband.

Considerations when Using PI Temperature Control

Several factors, such as room heat load, external heat gains, and component specific performance can affect the PI control loop. Adjusting the temperature proportional band and integration time can improve cooling unit performance and avoid problems detailed in **Table 3.1** below.

Table 3.1 PI Temperature Control Troubleshooting

Problem	Solution
Cooling is slow to activate	Decrease the proportional band slightly and monitor operation. Repeat until cooling-reaction time is acceptable.
Compressor short-cycle alarm	Increase the proportional band slightly by increasing the integration time between 3 and 5 minutes, and monitor compressor run time. Set the temperature deadband to 2. Run time must be more than 3 minutes to prevent a short-cycle of the compressor.
Excessive valve oscillation or hunting	Increase the proportional band and/or increase integration time.

3.1.4 Compressor Control by Cooling Requirement

Compressor control is directly linked to temperature control in that the cooling requirement determined by the temperature proportional band determines compressor operation. Depending on the type of cooling unit, the number and type of compressors varies. The following describes compressor operation along the proportional band for the varying compressor options.

Digital Scroll Compressors

Digital scroll compressors use time loaded/unloaded to modulate cooling capacity between 10% and 100% to control cooling more precisely than non-digital compressors. Capacity modulation is achieved by opening and closing a digital solenoid valve in 15 second intervals while the compressor runs continuously when the cooling requirement is 10% to 100%.

- When the valve is opened (energized, the compressor is unloaded and capacity is 0% (because the scroll plates are separated so that there is no refrigerant flowing through the compressor).
- When the valve is closed (de-energized), the compressor is loaded and capacity is 100%.
- Capacity is determined by the amount of time that the valve is closed in the 15 second interval. **Figure 3.3** below illustrates solenoid-valve operation when cooling requirement is 66%.
 - The valve is closed for 10 seconds (100% cooling).
 - Then open for 5 seconds (0% cooling).
 - This results in 66% cooling. Essentially, the compressor is partially loaded.

Figure 3.3 Digital Scroll Compressor Operation to Provide 66% Cooling Capacity

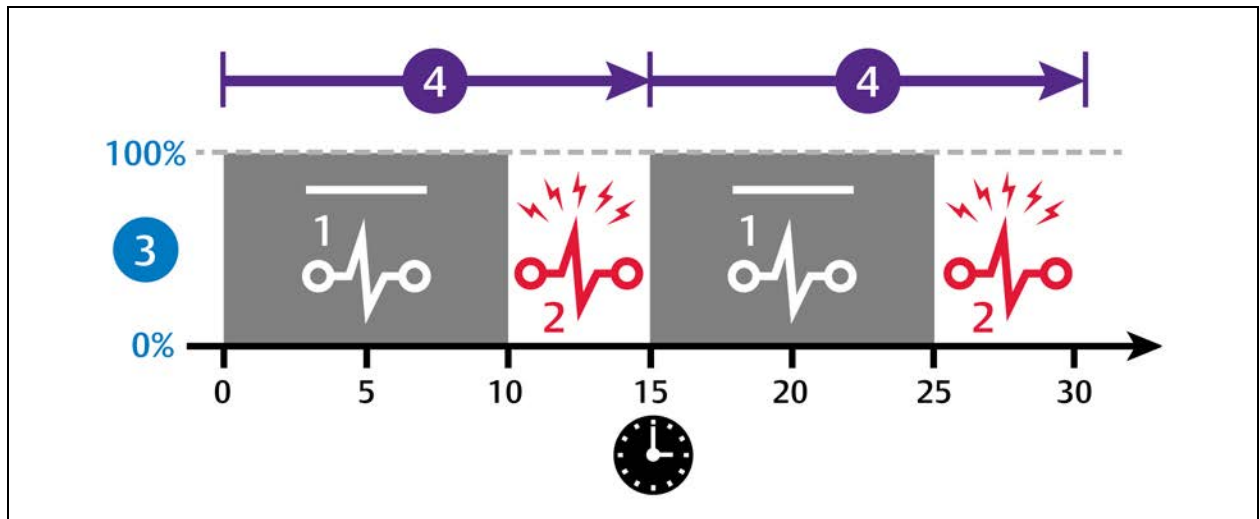

No.	Description
1	Solenoid de-energized.
2	Solenoid energized.
3	Percent loaded.
4	15 second capacity modulation cycle.

Dual Digital Scroll Compressors

In a two digital scroll system, the compressors operate in a lead lag configuration:

- The lead compressor starts when the cooling demand is at least 25% (calculated from temperature proportional band) and operates at 50% capacity (valve open 7.5 seconds/closed 7.5 seconds) for an initial period set in Winter Start Delay, see [Setting Low Pressure Time Delay](#) on page 43 , after which it operates per cooling demand.
- The lag compressor starts when cooling demand is 35% and operates at 70% capacity, increasing capacity as cooling demand increases.
- On both compressors at 100% cooling requirement, the valve remains closed for the entire 15 second interval and the compressors operate loaded at 100% capacity.
- The lag compressor stops when the cooling demand decreases to 20%.
- The lead compressor stops when cooling demand decreases to 10%.

Figure 3.4 on the next page illustrates digital scroll compressor operation with the following setpoint parameters:

- 70° setpoint
- 8° proportional band
- 2° deadband

Figure 3.4 Compressor Control—Dual Digital Scroll Compressor

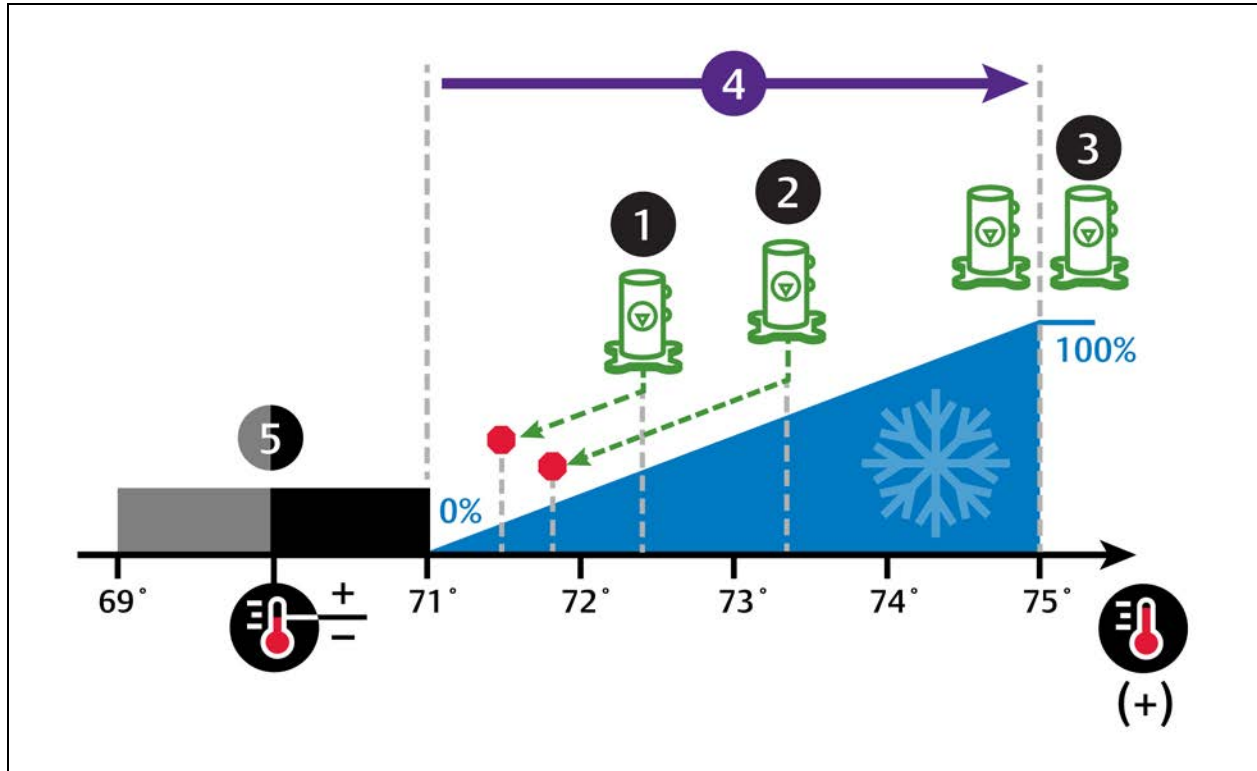

No.	Description
1	Lead compressor.
2	Lag compressor.
3	Lead and lag compressors.
4	½ of proportional band.
5	Deadband

Tandem Compressor Sets

A tandem compressor set consists of one digital scroll compressor and one fixed capacity, standard scroll compressor on a circuit. Typically, tandem compressors are employed in dual circuit Vertiv™ Liebert® DSE units with circuit 1 on the outer coil and circuit 2 on the inner coil as shown in the example in above .

In Vertiv™ Liebert® iCOM™, tandem compressors use the following naming convention:

- Compressor 1A is digital-scroll and Compressor 1B is fixed, standard scroll. These comprise tandem-compressor set 1.
- Compressor 2A is digital-scroll and Compressor 2B is fixed, standard scroll. These comprise tandem-compressor set 2.

[Selecting Event Type and Setting Alarm/Warning Notification](#) on page 49 describes the alarm events associated with the tandem compressors. If an alarm condition affects both tandem sets, tandem-compressor set 1 acts as the lead until the alarm is reset and the compressors reactivated. Once the alarm is cleared and the compressors activated, the lead-lag settings chosen for Compressor Sequence resume, see [Setting Compressor Options](#) on page 42 .

The compressors operate in stages to maintain the selected temperature setpoint. The stages are defined by the compressors that operate during that stage and the begin operating and ramp up or down based on the call-for-cooling percentage, see **Table 3.2** below, for typical operation. The loading routine may vary based on transient room conditions, but in the tandem set the compressors operate as follows: The digital scroll compressor in the lead set activates on a call for cooling and ramps between 20% and 100% to meet the requirement. If the call exceeds the digital scroll's capacity, the fixed-capacity compressor activates and the digital scroll ramps down.



Table 3.2 Cooling Stages and Compressor Operation in a Dual-Circuit System with Tandem Compressors

Cooling Stage	Compressor(s) Operating	Unit Capacity to Meet Room Load
1	Digital-scroll 1A modulating	Up to 25%
2	Digital-scrolls 1A and 2A modulating	25% to 50%
3	Digital-scrolls 1A and 2A modulating, Fixed 1B	50% to 75%
4	Digital-scrolls 1A and 2A modulating, Fixed 1B and 2B	75% to 100%

3.1.5 Setting Temperature Compensation

Temperature compensation provides protection from changes that affect capacity and heat load by monitoring temperature conditions and fan-speed settings, then automatically adjusting the temperature setpoint. Changes that may cause temperature compensation are floor tile removal in non-cold aisle areas, incorrect supply temperature setpoint, unit failure in a neighboring zone, or unexpected heat load fluctuations at rack equipment.

Temperature compensation is also tied-in to cascade/stand-by operation in Teamwork Mode 3. See [Teamwork Mode 3—Optimized Aisle Operation](#) on page 68.

1. Touch , then  > *Setpoints* > *Temperature Compensation*.
The TEMPERATURE COMPENSATION secondary panel opens.
2. Select the Compensation Type, then touch Save. The setpoint is updated.
 - Return temperature compensation cannot be used when both fan and cooling control is set to Return.
 - Supply temperature compensation requires the following settings:
 - Temperature Control Sensor: Supply Sensor
 - Fan Control Sensor: Remote Sensor

NOTE: When temperature compensation is enabled and active, the Temperature Setpoint Act field on the Temperature Control setpoints panel displays the adjusted setpoint value.

NOTE: Depending on the type of thermal management unit, included components, and control settings of your system, all of the options listed may not be available on your Vertiv™ Liebert® iCOM™ display.

Temperature Compensation Options

Compensation Type

Selects the compensation routine:

- No: Temperature compensation routine disabled.
- Return: Increases the temperature setpoint when the return air temperature is too cold.
- Supply: Decreases the temperature setpoint when the air flow capacity approaches 100% and the cold aisle temperature remains above the setpoint.
- Supply+Return: Allows both supply and return compensation.

3.1.6 Fan Temperature Compensation

For applications where unit fan speed is being controlled off the return sensor, Vertiv™ Liebert® iCOM™ shall also support the capability of simultaneously utilizing remote 2T sensor values to override the return air temperature setpoint associated with fan speed control. Once enabled, when a high remote temperature is detected, the Fan Temperature Compensation routine shall temporarily increase fan speed output to compensate for the high remote temperature by decreasing the return temperature setpoint by a value specified by the end-user.

The remote 2T sensors required for this feature shall monitor cold aisle temperatures while fan speed is driven by the return air sensor and corresponding setpoint. As the remote temperature increases above the Fan Temp Comp – Remote Setpoint, fan speed control setpoint (return air setpoint) shall begin to decrease starting with 0°F/0.0K adjustment when at the remote setpoint and ending with the maximum adjustment as defined by Fan Temp Comp – Adjust Band (i.e. Fan Temp Comp – Rem Temp Setpoint + Fan Temp Comp – Rem Band). In the event the remote temperature sensor reading is considered invalid, Liebert® iCOM™ shall fall back and use Fan Temp Comp – Rem Temp Backup value for control. When the remote temperature is continuously above the sum of Fan Temp Comp – Remote Setpoint + Fan Temp Comp – Rem Band, the Fan Temp Comp Limit alarm event shall annunciate after the defined delay time has surpassed.

Fan Temp Comp – Operation – Enables/disables Fan Temperature Compensation routine.

Fan Temp Comp – Rem Temp Setpoint – Remote temperature threshold at which routine activates.

Fan Temp Comp – Rem Band – Adjustment band.

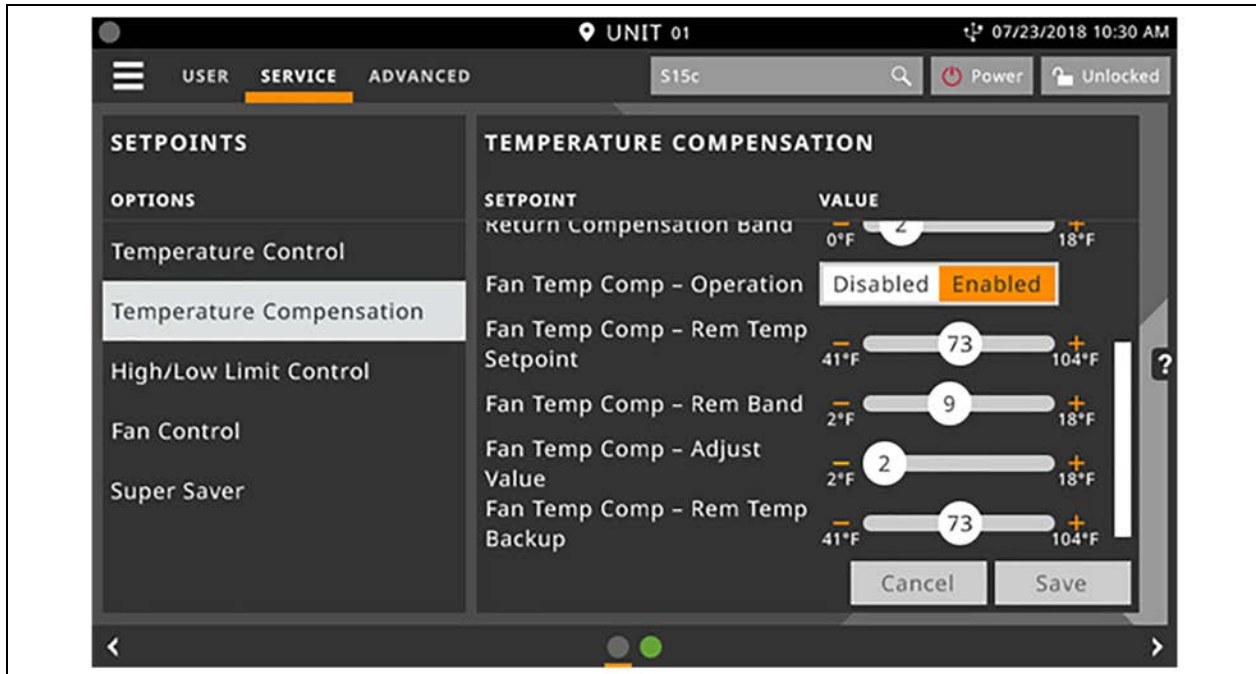

Fan Temp Comp – Adjust Value – Value subtracted from return temperature setpoint as remote temperatures rise above.

Fan Temp Comp – Rem Temp Backup – Remote temperature backup value which shall be used in the event remote sensor values are considered invalid.



3.1.7 Configuring High/Low Limit Setpoints

To Set High and Low Limits

1. Touch , then  > *Setpoints* > *High/Low Limit Control*. The HIGH/LOW LIMIT CONTROL secondary panel opens.
2. Adjust the setpoint options, then touch *Save*. The setpoint is updated.
 - Touch *Cancel* to discard the changes.

NOTE: Depending on the type of thermal management unit, included components, and control settings of your system, all of the options listed may not be available on your Vertiv™ Liebert® iCOM™ display.

High/Low Limit Control Options

High Return Limit

Enables/disables use of additional fan speed based on return air temperature.

Return Limit P-band

Calculates fan speed based on proportional deviation from the return air temperature.

Supply Limit Enabled



Enables/disables use of additional fan speed based on supply air temperature.

Supply Temp Limit Setpoint

Supply air temperature at which use of additional fan speed is enabled.

3.1.8 Configuring Fan Setpoints

Configures fan speed control to operate independent of compressor loading (de-coupled mode).

1. Touch , then  > *Setpoints* > *Fan Control*. The FAN CONTROL secondary panel opens.
2. Adjust the setpoint options, then touch *Save*. The setpoint is updated.
 - Touch *Cancel* to discard the changes.

NOTE: Depending on the type of thermal management unit, included components, and control settings of your system, all of the options listed may not be available on your Vertiv™ Liebert® iCOM™ display.

Fan Control Options

Airflow Calibration

Maximum allowed fan output voltage.

Fan Control Sensor

Selects the sensor that controls automatic fan-speed, see [Automatic Fan Speed Control](#) on page 32 ,

– or –

Selects manual control, see [Manual Fan Speed Control](#) on the facing page .

Options are:

- Supply: Air flow/fan speed is adjusted based on reading from the supply air-temperature sensor.
- Remote: Air flow/fan speed is adjusted based on reading from a wired, remote temperature sensor.
- Return: Air flow/fan speed is adjusted based on reading from the wired, return air-temperature sensor.
- Manual: Air flow/fan speed is adjusted using a building-management system.

Fan Control Type

Selects the method of control for the fan motor.

- Auto: Air flow/fan speed is adjusted using locally installed temperature sensors.
- Proportional: Regulation based on the difference between the fan control sensor reading and the fan setpoint.
- PI: Regulation is based on proportional and integral terms. Provides best temperature control and helps avoid fan speed oscillation.
- Adaptive PID: Auto-tuning PID control loop, can be set for cooling or fan speed.

Fan Delta

Fan temperature setpoint, it is the temperature difference compared to the cooling setpoint.

Fan Speed Proportional Band

Adjusts the fan speed based on the deviation from the setpoint. A smaller number causes faster reaction to temperature changes.

Fan Speed Integration

Adjusts fan speed based on time away from the setpoint to maintain accurate temperature control.

Maximum Fan Speed

Maximum percentage at which the fans will operate.

Minimum Fan Speed





Minimum percentage at which the fans will operate.

3.1.9 Manual Fan Speed Control





In Manual fan control mode, the speed of the motor can be set in one of the following ways:

- The manual (fixed) fan speed may be set via Vertiv™ Liebert® iCOM™.
- Hard-wired analog input (input-signal types including 4 to 20 mA, 0 to 10 VDC, and 0 to 5 VDC) and a factory supplied isolator to ensure reliable communication.
- Remotely using a Vertiv™ Liebert® IntelliSlot card.

Setting Manual Fan Speed Control via Analog Input

1. Touch , then  > *Setpoints* > *Fan Control*, set *Fan Control Sensor* to *Manual*, then touch *Save*.
2. Touch , then  > *Auxiliary Device Setup* > *Analog Input*.
3. On ANALOG INPUTS, touch *Customer Analog Inputs* to expand it, then touch the analog-input device corresponding to fan speed control.
4. On the ANALOG INPUT PROPERTIES panel, adjust the properties, then touch *Save*.
 - Touch *Cancel* to discard the changes without saving.

Setting Manual Fan Speed Control via Building Management System

1. Touch , then  > *Setpoints* > *Fan Control*, set *Fan Control Type* to **Manual**, then touch *Save*.
2. Touch , then  > *BMS & Teamwork Setup* > *BMS Setup*.
3. On BMS SETUP, touch *Control Settings*. The CONTROL SETTINGS secondary panel displays:
 - In *Fan Control Sensor*, select *Manual*.
 - In *BMS Fan Speed Local Override*, select *No*.
 - Touch *Save*. BMS control of fan speed is set, and the BMS set fan speed is displayed on the Fan Speed slider.

NOTE: Set the fan speed via BMS by writing to the Fan Speed Maximum Set Point monitoring point. For details, see SL-28170 IntelliSlot Reference Guide found at <https://www.vertiv.com/en-us/support/>.

NOTE: Local adjustments to fan speed are overridden when remote/BMS fan-speed control is set.

3.1.10 Automatic Fan Speed Control



Temperature sensors can control fan speed using one of three modes based on the type of sensor selected as the fan control sensor: supply, return, or remote. See **Table 3.3** below. Control is based on the selected sensor for both fan control and temperature control and their setpoints as follows:

- Coupled: The fan control and temperature control sensor selection is the same. When coupled, fan speed is determined by the temperature setpoints.
- Decoupled—the fan control and temperature control sensor selection is different. When decoupled, fan speed is determined by the fan setpoints.

Table 3.3 Fan Speed Controlling Sensor Options

		Temperature Control Sensor selected		
		Supply Sensor	Remote Sensor	Return Sensor
Fan Control Sensor selected	Supply Sensor	Coupled	N/A	N/A
	Remote Sensor	Decoupled (Recommended)	Coupled	N/A
	Return Sensor	Decoupled	Decoupled	Coupled



To Set Parameters for Automatic Fan Speed Control

1. Touch , then  > *Setpoints* > *Fan Control*,
 - Set *Fan Control Type* to *Manual*
 - Select a *Fan Control Sensor*.
 - Adjust the setpoint options, then touch *Save*.

Sensor based fan speed control is set.

2. Touch *Temperature Control*.
3. On the TEMPERATURE CONTROL secondary panel:
 - Select a *Temperature Control Sensor*.
 - Adjust the setpoint options, then touch *Save*.

3.1.11 Configuring Static Pressure Setpoints

1. Touch , then  > *Setpoints* > *Static Pressure Settings*. The STATIC PRESSURE SETTINGS secondary panel opens.
2. Adjust the setpoint options described in the [Static Pressure Settings Options](#) on the facing page, then touch *Save*. The setpoint is updated.
 - Touch *Cancel* to discard the changes.

NOTE: Depending on the type of thermal management unit, included components, and control settings of your system, all of the options listed may not be available on your Vertiv™ Liebert® iCOM display.

Static Pressure Settings Options

Current Override Temperature

Current temperature reading of the sensor selected for static pressure control override.

Current Override Value

Percentage of override from 0% (no override/static pressure control only) to 100% (temperature-sensor reading overrides completely).

Full Speed at

Temperature at which override reaches 100% and fan operates at full speed.

Operation at Static Pressure Sensor Failure

Selects operation in the event that the static pressure sensor fails. Values are:

- Freeze Speed: Current fan speed is kept.
- SP Off: Static pressure control is disabled and fan speed is dictated by selected fan speed sensor.

Override Integration Time

Adjusts amount of override based on the length of time the temperature has deviated from the setpoint.

Override Slew Rate Filter

Rate of change filter to slow down fan speed changes.

Static Pressure Control Override

Selects sensor that may override static pressure control if the temperature gets too far from the temperature setpoint to provide additional air flow because static pressure is not able to maintain the temperature. Values are:

- None: Override is disabled.
- Remote Sensor: The remote sensor overrides static pressure control.
- Return Sensor: The return sensor overrides static pressure control.

Static Pressure Min Pause

Minimum initial length of time that fan speed stops increasing after the pressure reading crosses into the deadband. After the pause, the fan speed pulses (increases if below the setpoint and decreases if above the setpoint) for the period selected in the Static Pressure Pulse inside deadband field. After each pulse, a pause takes place, the length of which is calculated as a ratio between the deadband border (minimum) and the setpoint (maximum).

Static Pressure Max Pause

Maximum initial length of time that fan speed stops increasing after the pressure reading crosses into the deadband. After the pause, the fan speed pulses (increases if below the setpoint and decreases if above the setpoint) for the period selected in the Static Pressure Pulse inside deadband field. After each pulse, a pause takes place, the length of which is calculated as a ratio between the deadband border (minimum) and the setpoint (maximum).

Static Pressure Pulse Inside Deadband

Period of time the fan speed increases or decreases (pulses) when pressure is inside the deadband.

Static Pressure Requested Speed Up To

Temperature at which static pressure control override begins.

3.1.12 Supply Sensor Aggregation

When more than one supply air sensor is required to be used for cooling capacity control (temperature control), the Supply Sensor Aggregation feature may be enabled. Supply Sensor Aggregation feature allows the use of multiple temperature sensors which are programmed to create a single, aggregated supply air temperature value which may be used for cooling capacity control.

Vertiv™ Liebert® iCOM™ shall support a maximum of six sensors for Supply Sensor Aggregation calculation. Up to five additional remote 2T sensors may be connected to a given Liebert® iCOM™ controller and programmed for Supply Sensor Aggregation. The standard Supply NTC sensor may also be included/excluded in the aggregated supply temperature calculation Liebert® iCOM™. The end-user shall have the ability to determine whether the supply sensor aggregation calculated value is based on the Average of all the sensor values or Maximum (worst case) temperature reading. Invalid sensor readings will not affect the unit calculation (they will be excluded).

Enabling Supply Sensor Aggregation

Via the Liebert® iCOM™ display, navigate to Service Menu > Auxiliary Device Setup > Sensors > Supply Sensor Aggregation Setup.

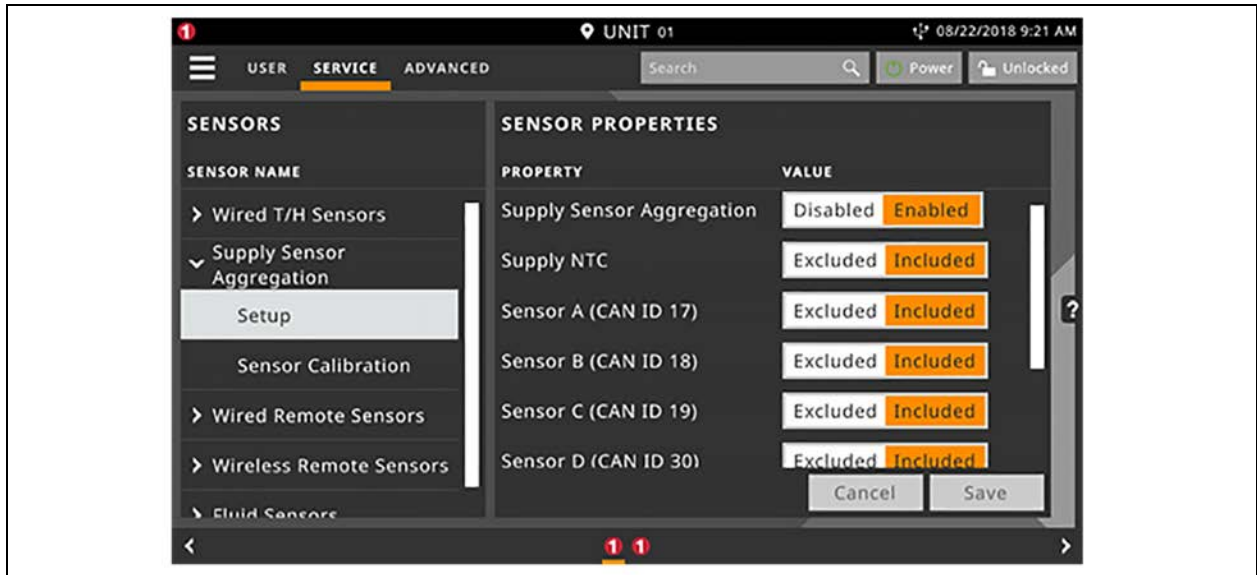

The additional Remote 2T sensors must be properly addressed in order to be used in this calculation. The standard addressing of these sensors differs from that of the 10 additional remote 2T sensors Vertiv™ Liebert® iCOM also supports. The end-user shall have the ability to determine which of the connected sensors may be included/excluded in the Supply Sensor Aggregation calculation via the toggle shown in the image above. End-users will also the capability of calibrating each sensor.

The information below represents the CANbus addressing of the additional remote sensors which shall be used for Supply Sensor Aggregation calculation:

Sensor	CANbus Node	Dip Switch Position SW1-1	Dip Switch Position SW1-2	Dip Switch Position SW1-3	Dip Switch Position SW1-4	Dip Switch Position SW1-5	Dip Switch Position SW1-6
Sensor A	17	ON	OFF	OFF	OFF	ON	OFF
Sensor B	18	OFF	ON	OFF	OFF	ON	OFF
Sensor C	19	ON	ON	OFF	OFF	ON	OFF
Sensor D	30	OFF	ON	ON	ON	ON	OFF
Sensor E	31	ON	ON	ON	ON	ON	OFF

NOTE: * Sensor A-C may be Remote T/H or Remote 2T sensors. Sensors D & E must be Remote 2T sensors.

3.2 Scheduling Condenser and Cooling Unit Tasks



The Scheduler configures operating conditions and modes for specific intervals. Tasks to schedule include:

- Condenser set back: See [Scheduling Condenser Low-noise Operation](#) below .
- Condenser fan-reversal: See [Scheduling Condenser Fan Reversal](#) on the next page .
- Unit sleep Schedule: Turns off units during times of low demand and controlled only by temperature. Sleep is interrupted if the return temperature rises above the alarm threshold.

3.2.1 Scheduling Condenser Low-noise Operation

Condenser setback schedules low-noise fan operation on units equipped with Vertiv™ Liebert® MC premium efficiency control. Fans spin more slowly during specified times to reduce noise, and faster when low-noise is unnecessary.

NOTE: Low noise operation is overridden to prevent a high pressure condition.

1. Touch , then  > Scheduler > Condenser Setback Schedule. The TASK PROPERTIES panel opens.
2. Adjust the schedule settings, and touch Save. The schedule is set up.
 - Touch *Cancel* to discard the changes.

Condenser Setback Task Properties Options

Disabled Day

Selects specific days on which noise reduction operation is disabled when the schedule is enabled.

Interval 1

Start and finish time of day that noise reduction operates.

Interval Day

Selects days on which noise reduction operation for the interval specified in Interval 1.

Max Speed in Low Noise Mode

Sets the maximum speed for the condenser fan during low-noise operation.

Max Speed in Normal Mode

Sets the maximum speed for the condenser fan during normal or high efficiency operation.

Noise Reduction

Enable/disable noise reduction. When checked, the schedule is run. When not checked, the scheduling parameters are ignored.

Status



Indicates if low noise operation is active or inactive.

Whole Day

Selects whole days for which noise reduction operation is available for the condenser fan.

3.2.2 Scheduling Condenser Fan Reversal

Condenser fan reversal schedules a reversal of the condenser fans, reversing air flow to help remove dust, paper, leaves and such from the suction side of the condenser coil.

1. Touch , then  > *Scheduler* > *Condenser Fan Reversal Schedule*. The TASK PROPERTIES panel opens.
2. Adjust the schedule settings, and touch *Save*. The schedule is set up.
 - Touch *Cancel* to discard the changes.

Condenser Fan Reversal Task Properties Options**Reverse Fans At Duration**

Length of time, in seconds, the fans are reversed.

Reverse Fans Every



Selects number of days between fan reversal.

Reverse Fans Now

Enables/Disables immediate fan reversal.

3.2.3 Scheduling Sleep Times for Thermal Management Units

Unit sleep schedules turn off units during low demand as long as return temperature remains below the alarm threshold.

1. Touch , then  > *Scheduler* > *Unit Sleep Schedule*. The TASK PROPERTIES panel opens.
2. Adjust the schedule settings, and touch *Save*. The schedule is set up.
 - Touch *Cancel* to discard the changes.

Unit Sleep Schedule Task Properties Options

Interval 1/2

Start and finish time of day that sleep mode operates.

Interval Day

Selects days on which sleep mode operates for the intervals specified in Interval 1 and Interval 2.

Sleep Mode

Enable/disable sleep schedule. When checked, the schedule is run. When not checked, the scheduling parameters are ignored.

Timer Mode Type

Selects unit operation when in sleep mode. Values are:

- Unit Off: The unit stops (fans are off).
- Deadband: The unit operates in a limited capacity (fans are on) based on an additional deadband added to the temperature deadband.

Timer Reset

Selects whether or not the sleep mode timer resets.



Whole Day

Selects specific days on which sleep mode is active for the entire day when the schedule is enabled.

3.3 Setting General Thermal Management Unit Options

NOTE: Depending on the type of thermal management unit, included components, and control settings of your system, all of the options listed may not be available on your Vertiv™ Liebert® iCOM™ display.

3.3.1 Setting Miscellaneous Options

1. Touch , then  > *Options Setup* > *Misc Settings*. The MISC SETTINGS panel displays.
2. Make adjustments as needed and click *Save*. The option settings are updated.
 - Touch *Cancel* to discard the changes without saving.

NOTE: Depending on the type of thermal management unit, included components, and control settings of your system, all of the options listed may not be available on your Vertiv™ Liebert® iCOM™ display.

Miscellaneous Cooling Unit Settings Options

Auto Restart Enable

When enabled, the cooling unit returns to the status at which it was operating when input power returns after a power failure. (On if it was powered on and Off if it was powered off before the failure.) See [Automatic Restart after Power Failure](#) on page 40 .

Cascade after Remote On

Upon a remote request for all units to start, selects whether or not the units start one after another by the Cascade Units Delay set in [Teamwork Modes](#) on page 65 , see the [Teamwork Control Options](#) on page 66 .

Free Cool Capacity Transition Filter

Selects how quickly capacity changes between modes of operation to avoid overshooting during the transition.

- Only a factory trained service technician should adjust this setting.

K11 Active On

Selects the action of the activated K11 (warning) relay. Options are:

- Dehum: Dehumidification is on.
- Warning: A warning is active.
- Emergency Pwr: Emergency power is on.
- Freecooling: Freecooling is on.
- FC Start: Freecooling is in the start phase or is on.

Loss of Power Autoreset Delay

Selects the length of time that a Loss of Power event (that triggers after a power cycle that occurs when the cooling unit is operating) is active when power is restored. When the delay time elapses, the event resets and is cleared automatically.

Operation at Temp Control Sensor Failure

Selects cooling unit operation in the event that the control temperature sensor fails.

- Shut Down: The unit shuts down on sensor failure.
- Cooling: The unit continues operation based on the select Temp Control Sensor Failure Cooling Mode.

Single Unit Auto Restart

Selects time elapsed (in seconds) before unit restarts when Auto Restart Enable is enabled.

Temp Control Sensor Failure Cooling Mode

Unit operation when Cooling is selected at control temperature sensor failure.

- Hold: Holds the last call for cooling. That is, continue operating at same capacity.
- Full: Activates full cooling, 100% capacity.



Warning Activates Alarm Relay

When enabled, a warning event activates the common alarm relay.

3.3.2 Configuring Quick Start

In the event of a power interruption to the Vertiv™ Liebert® iCOM™ controller, the unit components and controls shut down. Normally, after power is restored, the Liebert® iCOM™ controller must fully boot, and no cooling or air flow occurs until the controls have fully booted. Quick Start lets you determine the fan and cooling output that the unit will provide before the controller fully boots. When configured, the unit can provide airflow and cooling within 10 seconds after power is restored to the controller. Quick Start can be applied to fan, chilled water, DX, and PRE-pump functions. Quick Start operates only during Liebert® iCOM™ application boot, then normal controller operation resumes.

To Configure Quick Start

1. Touch , then  > *Options Setup* > *Quick Start Settings*.
The QUICK START SETTINGS panel displays.
2. Refer to below, and select the configuration options for your system.

NOTE: Depending on the type of thermal management unit, included components, and control settings of your system, all of the options listed may not be available on your Vertiv™ Liebert® iCOM™ display.

Quick Start Options

DX Quick Start

Enables/disables DX quick start.

DX Quick Start Initial Call for Cooling

Compressor output percentage (call for cooling) during quick start operation (0 – 100%).

DX Quick Start with Econophase

Enables/disable Econophase operation during quick start. When enabled on DSE thermal management units, note the following:

- If unit was operating in pump mode at the time of power loss, unit restarts in pump mode.
- If unit was operating in mixed mode at the time of power loss, unit restarts in mixed mode.
- If unit was operating in compressor mode at the time of power loss, unit restarts in compressor mode.

Fan Quick Start

Enables/disables fan quick start.

Pump Start Call For Cooling

Output percentage of PRE pump quick start operation (50 – 100%).

Quick Start Delay

Delay before quick start activates after power is restored (0 to 180 sec).

NOTE: When using DX quick start, you must configure a minimum of 40 seconds to allow time for global condenser communication to establish before the compressors are powered on.

Quick Start Fan Analog Output



Fan speed percentage during quick start operation.

Quick Start Overlap Time

Length of time quick start fan speed overlaps normal fan speeds settings. After fully booted, normal fan speed control resumes when this time expires.

3.3.3 Automatic Restart after Power Failure



Set the cooling unit to return to the status at which it was operating when input power returns after a power failure. (On if it was powered on and Off if it was powered off before the failure.)

1. Touch , then  > *Options Setup* > *Misc Settings*. The MISC SETTINGS panel displays.
2. Set *Auto Restart Enable* to *Yes*, and use the slider to set the number of seconds to delay before restart, then touch *Save*.
Automatic restart is enabled.
 - Touch *Cancel* to discard the changes without saving.

3.3.4 Setting Fan Options

Air flow is adjustable via Vertiv™ Liebert® iCOM™ manually using a building management system (BMS) or automatically using locally installed temperature sensors.

NOTE: Thermal management units ship with the factory setting Return Sensor for the temperature-control sensor and the fan speed control sensor.

1. Touch , then  > *Options Setup* > *Fan Settings*. The FAN SETTINGS panel displays.
2. Make adjustments as needed and click *Save*. The option settings are updated.
 - Touch *Cancel* to discard the changes without saving.

NOTE: Depending on the type of thermal management unit, included components, and control settings of your system, all of the options listed may not be available on your iCOM display.

Fan Settings Options

Air Flow Calibration

Maximum allowed fan output voltage.

Allow Fan Modulation with Comp

Enables/disables fan modulation with compressor operation. Values are:

No: Fan speed ramps to STD when a compressor starts operating.

Yes: Fan speed modulates based on CFF while compressor operates.

Fan Backdraft Mode

Enables/disables fan operation in back draft mode.

Fan Shutdown Delay Timer

Length of time that the fan continues to operate after the cooling unit is turned off via the display, local control or the BMS.

- The delay timer does not apply when the unit is turned off remotely.

Fan Speed at Unit Start

Speed at which the fans run on unit start up.

Fan Speed at Unit Start Timer

Length of time fans run at the speed selected in fan speed at unit start.

Fan Speed Filter at 0%

Decreases the rate at which the fan speed changes when close to or at the temperature setpoint to avoid undershooting the setpoint.

Fan Speed Filter at 100%

Increases the rate at which the fan speed changes for a quicker reaction of fan speed at high temperatures.

Fan Speed Reposition Delay

Length of time before fan speed can decrease, allowing temperature to stabilize before the change occurs.

Fan Speed Reposition Mode

Sets a one time delay that allows the fan to maintain current speed when a call to increase or decrease is made to allow the temperature to stabilize.

Fanspeed Transition Filter

Sets how quickly the fan speed changes between operating modes. Prevents an instant reaction when fans turn on or off and prevents unstable operation.

Max Deceleration Rate

Selects the rate and which the fan speed changes during deceleration.

Maximum Fan Speed

Maximum speed at which the fan will operate.

MIN at CFC for EC Fan

Cooling deviation at which the fan will operate at minimum speed.

Minimum Fan Speed

Minimum speed at which the fan will operate.



No Power Fan Speed

Speed at which the fans operate when using emergency power.

STD at CFC for EC Fan

Cooling deviation at which the fan will operate at maximum speed.

3.3.5 Setting Compressor Options

1. Touch , then  > *Options Setup* > *Compressor Settings*. The COMPRESSOR SETTINGS panel displays.
2. Make adjustments as needed and click *Save*. The option settings are updated.
 - Touch *Cancel* to discard the changes without saving.

NOTE: Depending on the type of thermal management unit, included components, and control settings of your system, all of the options listed may not be available on your Vertiv™ Liebert® iCOM™ display.

Compressor Settings Options

Ball Valve Setpoint Offset

Adjusts sensitivity to compressor discharge pressure or liquid pressure by increasing sensitivity. The higher the added pressure, the more the valve opens.

Capacity Change at 0%

Decreases the rate at which cooling capacity changes when close to or at the temperature setpoint to avoid undershooting the setpoint.

Capacity Change at 100%

Increases the rate at which the cooling capacity changes for a quicker reaction of cooling at high temperatures.

Compressor Sequence

Selects the lead compressor when cooling activates. Values are:

- Auto: Compressor with the lowest run hours leads.
- 1: Compressor 1 leads.
- 2: Compressor 2 leads.



Winter Start Delay

Length of time, in minutes, that a low pressure condition is ignored during compressor start-up. See [Setting Low Pressure Time Delay](#) below .

Setting Low Pressure Time Delay

At compressor start-up, a low pressure condition is ignored for a set period to avoid false trips due to bubbles in the refrigerant or other misreading of the low-pressure device.



NOTE: The factory default setting is a three minute delay for air cooled units and a zero to one minute delay for water cooled units.

1. Touch , then  > *Options Setup* > *Compressor Settings*.
2. Use the *Winter Start Delay* slider to select the number of minutes for the delay, and touch *Save*.

Adjusting Ball Valve Pressure Offset

NOTE: Only a properly trained and qualified technician should modify the motorized ball valve setting.

The number of times the valve opens and closes is adjusted based on added pressure offset.

1. Touch , then  > *Options Setup* > *Compressor Settings*.
2. Use the *Ball Valve Setpoint Offset* slider to select amount of pressure added to open the valve wider, and touch *Save*.

Compressor Sequencing for Balancing Run Times



Compressor sequencing, available in two compressor cooling units, allows assigning a lead compressor or allowing automatically leading with the compressor with the lower run hours logged.

When Auto is selected, the following applies as Vertiv™ Liebert® iCOM™ attempts to maintain equal run time of the compressors:



- If only one compressor is available because of safety delays, it is given first priority to start/stop.
- If both compressors are off, the compressor with fewer run hours is the next to start.
- If both compressors are operating, the compressor operating for the longest time since the last start is the first to shut off.

NOTE: Automatic compressor sequencing will not power off a compressor if it is required to properly condition the space.

To Set Up Compressor Sequencing

1. Touch , then  > *Options Setup* > *Compressor Settings*.
2. Select the *Compressor Sequence* option to use, and touch *Save*.

3.3.6 Setting Q15 Options

1. Touch , then  > *Options Setup* > *Q15 Settings*. The Q15 SETTINGS panel displays.
2. Make adjustments as needed and click *Save*. The option settings are updated.
 - Touch *Cancel* to discard the changes without saving.

Q15 Settings Options

Damper Switch Feedback Timer

If output function is Damper and End Switch, the length of time Liebert® iCOM™ waits for the feedback signal from the damper motor, that is, if it is open or closed.

Fan Delay for Damper

Length of time that must elapse during damper opening/closing. During this span, all functions associated with the on/off state are eligible.

Medium Board: Q15 map to K11

Maps the Q15 function to the K11 (warning) relay because a medium-sized board does not have Q15 output.

Q15 Output Direction

Selects whether the output is normally-on or normally-off.

Q15 Output Function

Selects the reason for which the digital output is activated. Options are:

1 = Dehum On	9 = FreeCool ON
3 = Reheat On	10 = Damper
4 = Comp On	11 = High Temp
5 = Comp 1 On	12 = Low Temp
6 = Comp 2 On (in dual-compressor systems)	13 = Loss Power
7 = Humi On	14 = Power Source

Q15 Output Sensor

Selects a sensor reading to compare to the set threshold that activates Q15 output. Options are:

- 0: Return
- 1: Supply
- 2: Rem Max
- 3: Rem Low
- 4: Rem Avg

Q15 Output State

Status of Q15 output, On or Off.

Q15 Temp Actual

Current value of the sensor selected as the Q15 Output Sensor.

Q15 Temp Output Threshold

Temperature threshold above or below which Q15 output activates.

This page intentionally left blank

4 Managing Events: Alarms, Warnings and Messages

NOTE: Your Vertiv™ Liebert® DSE Packaged Solution does not offer humidification or dehumidification functions. Please disregard those settings/fields when mentioned in this guide or displayed on the Vertiv™ Liebert® iCOM™ controller.

Events are notifications of operating status for the cooling unit, its components, and auxiliary devices. All events are recorded in the Event Log, and alarm and warning events are also displayed on the Alarms panel (See [Viewing the Event Log](#) on page 16, and [Viewing Unit Alarms](#) on page 14.)

In some cases, depending on configuration, an alarm event may power off the cooling unit, but not always. However, if a standby unit is configured, all alarm events stop the faulty unit and start the standby unit. Message and warning events do not.

4.1 Event Properties

The ALARMS & EVENTS panel lists all events available on the system. You can view and modify events and the criteria that trigger visual/audible alarms including:

- Critical thresholds
- Time delays
- Enable/disable
- Event type
- Adding custom events

NOTE: Not all event properties may be adjusted, depending on the criticality of the event, which is factory set.

4.1.1 To Open the Panel

Touch , then  > Alarm/Event Setup.

NOTE: Depending on the type of thermal-management unit, included components, and control settings of your system, the options on your Vertiv™ Liebert® iCOM™ display may differ.

4.1.2 Alarms & Events Panel Fields

Property

Lists groups of events, expanding displays the events in each group. See [Enabling Events and Editing Event Settings](#) on the next page.

Type

Event type. See [Selecting Event Type and Setting Alarm/Warning Notification](#) on page 49.

Ack

Indicates type of acknowledgment required. See [Acknowledging Alarms](#) on page 15 . This option is not available with all alarm types.

- Auto: The alarm is acknowledged automatically. It goes away if the situation that triggered alarm event is no longer true.
- Manual: The alarm goes away only when acknowledged, even if the situation that triggered the alarm event is resolved/no longer true.



Reset

Indicates type of reset required for the event. (This option is not available with all alarm types.)

- Auto : The alarm resets automatically after acknowledgment.
- Manual: The alarm must be reset manually after acknowledgment. See [Acknowledging Alarms](#) on page 15 .

4.2 Enabling Events and Editing Event Settings

In the ALARMS & EVENTS panel, events are grouped into categories for easier management, for example, the factory set remote sensor alarms and humidification/dehumidification events. In some cases, touch the group heading provides edit options for the entire group, like thresholds, delays and enable/disable. Each event includes settings specific for that event and the notification option where event type and alarm notifications are selected (See [Selecting Event Type and Setting Alarm/Warning Notification](#) on the facing page).

1. Touch , then  > *Alarm/Event Setup*. The ALARMS & EVENTS panel opens.
2. Scroll or search to find the event, touch the set's heading to display the properties and values for the entire set in the EDIT panel.
– or –
Touch an individual alarm or event to display it's specific values in the EDIT panel.

NOTE: To edit the event type and notification, see [Selecting Event Type and Setting Alarm/Warning Notification](#) on the facing page .

3. Use the EDIT panel to adjust the settings for the selected event or group of events.



4.3 Selecting Event Type and Setting Alarm/Warning Notification

Setting notification delays and disabling visual notification prevents nuisance notifications. Customize to notify of critical events on your cooling system.

NOTE: If the event includes a safety function, such as high pressure, low pressure, main fan overload, etc., the safety function executes regardless of event type or notification setting. However, notification timing delays still apply.

Table 4.2 on the next page, lists the default and adjustable notification settings for events. **Table 4.3** on page 52, describes events for the Vertiv™ Liebert® MC Condenser. **Table 4.4** on page 53, describes events for the Vertiv™ Liebert® EconoPhase unit. **Table 4.3** on page 52, describes events for the Vertiv™ Liebert® DSE compressors.

4.3.1 To Select Event Type and Notification

1. Touch , then  > *Alarm/Event Setup*.
2. Scroll or search to find the event and touch the alarm or event.
3. On the EDIT panel, touch *Notifications*. The EDIT panel displays the notification properties.
4. Adjust the notification properties described in [Notification Properties](#) below, then touch *Save*. The notification is updated.
 - Touch *Cancel* to discard the changes without saving.

Notification Properties

Delay

Time, in seconds, to delay notification after event trigger. Depending on the event, the delay may or may not be adjusted. **Table 4.2** on the next page lists the delays and their default settings.

- If the notification delay for the event is greater than the delay set for the event group, the group's delay includes the event's delay.

Enable

Enables/disables notification. Touch the switch to set On or Off.

- When disabled, events are not logged or displayed and visual/audible alarm notifications are not made.

Type

Logging and notification level of the event. **Table 4.1** below, describes the event type and notification it generates. **Table 4.2** on the next page, lists the default types for events.

Table 4.1 Notification Types

Type	Description
Message	Stored in event log only. No visual or audible notification.
Warning	Listed with a yellow status dot on the ALARMS panel and the LED flashes. See Table 11.1 on page 129, and Viewing Unit Alarms on page 14.
Alarm	Listed with a red status dot on the ALARMS panel, the LED flashes, and the audible alarm sounds. See Table 11.1 on page 129, Viewing Unit Alarms on page 14, and Enabling the Audible Alarm Notification on page 55.

Table 4.2 on the next page lists the default settings for each event.

- Internal delay is factory set and not adjustable. It is the time delay after event trigger that notification is sent.
- Default delay may or may not be adjustable and is added to the internal delay of event notification.
- Type may be adjustable or may be fixed.

NOTE: Depending on customization, some events may not be available on your cooling unit.

Table 4.2 Event Notification Defaults

Event	Internal Delay	Default Delay/Range for Adjustment	Type
MAIN FAN OVERLOAD	2 sec	5 sec/0 – 9999 *	ALM
LOSS OF AIRFLOW	3 sec	3 sec/0 – 9999 *	ALM
CLOGGED FILTERS	2 sec	2 sec/0 – 9999 *	WRN
HIGH ROOM TEMP	1 min. after fan on	30 sec/0 – 9999	Fixed to WRN
LOW ROOM TEMP	1 min. after fan on	30 sec/0 – 9999	Fixed to WRN
HIGH ROOM HUM	1 min. after fan on	30 sec/0 – 9999	Fixed to WRN
LOW ROOM HUM	1 min. after fan on	30 sec/0 – 9999	Fixed to WRN
HIGH TEMP SENSOR A	1 min. after fan on	30 sec/0 – 9999	Fixed to WRN
LOW TEMP SENSOR A	1 min. after fan on	30 sec/0 – 9999	Fixed to WRN
HIGH HUM SENSOR A	1 min. after fan on	30 sec/0 – 9999	Fixed to WRN
LOW HUM SENSOR A	1 min. after fan on	30 sec/0 – 9999	Fixed to WRN
COMP 1 OVERLOAD	Internal Calc.	no	ALM
COMP 2 OVERLOAD	Internal Calc.	no	ALM
COMP 1 HIGH PRESSURE	Internal Calc.	no	ALM
COMP 2 HIGH PRESSURE	Internal Calc.	no	ALM
COMP 1 LOW PRESSURE	Internal Calc.	no	ALM
COMP 2 LOW PRESSURE	Internal Calc.	no	ALM
COMP 2 PUMPDOWN FAIL	Internal Calc.	no	ALM
DIG SCROLL1 HIGH TEMP	Internal Calc.	no	ALM
DIG SCROLL2 HIGH TEMP	Internal Calc.	no	ALM
EL HEAT HIGH TEMP	5 sec	0 sec/0 – 9999	WRN
WORKING HRS EXCEEDED	0 sec	0 sec/0 – 9999	Fixed to WRN
SMOKE DETECTED	2 sec	2 sec/0 – 9999 *	ALM
WATER UNDER FLOOR	2 sec	2 sec/0 – 9999 *	ALM
COND PUMP-HIGH WATER	2 sec	2 sec/0 – 9999 *	ALM
LOSS OF FLOW	5 sec Reset delay: 10 sec	2 sec/0 – 9999 *	ALM
STBY GLYCOL PUMP ON	2 sec	2 sec/0 – 9999 *	ALM
STANDBY UNIT ON	2 sec	2 sec/0 – 9999 *	ALM
HUMIDIFIER PROBLEM	2 sec	2 sec/0 – 9999 *	ALM

Table 4.2 Event Notification Defaults (continued)

Event	Internal Delay	Default Delay/Range for Adjustment	Type
NO CONNECTION w/Unit1	Internal Calc.	-	WRN
UNIT X DISCONNECTED	Internal Calc.	-	WRN
LOSS OF POWER	0 sec	no	ALM
CUSTOMER INPUT 1	2 sec	2 sec/0 – 9999 *	ALM
CUSTOMER INPUT 2	2 sec	2 sec/0 – 9999 *	ALM
CUSTOMER INPUT 3	2 sec	2 sec/0 – 9999 *	ALM
CUSTOMER INPUT 4	2 sec	2 sec/0 – 9999 *	ALM
CALL SERVICE	2 sec	2 sec/0 – 9999 *	MSG
HIGH TEMPERATURE	2 sec	2 sec/0 – 9999 *	MSG
LOSS OF AIR BLOWER 1	2 sec	2 sec/0 – 9999 *	ALM
REHEAT LOCKOUT	2 sec	2 sec/0 – 9999 *	WRN
HUMIDIFIER LOCKOUT	2 sec	2 sec/0 – 9999 *	WRN
FC LOCKOUT	2 sec	2 sec/0 – 9999 *	WRN
COMPRESSOR(S) LOCKOUT	2 sec	2 sec/0 – 9999 *	WRN
COMP 1 SHORT CYCLE	0 sec	0 – 9999	MSG
COMP 2 SHORT CYCLE	0 sec	0 – 9999	MSG
No Power	0 sec	0 sec/0 – 9999WRN	
Condensate 1 Failure	0 sec	5 sec/0 – 9999	WRN
Condensate 2 Failure	0 sec	5 sec/0 – 9999	WRN
EC Fan Fault	0 sec	10 sec/0 – 9999	ALM
HIGH SUP TEMP	0 sec	30 sec/0 – 9999	WRN
LOW SUP TEMP	0 sec	30 sec/0 – 9999	ALM
REDUCED ECO AIRFLOW	0 sec	3 sec/0 – 9999	WRN
ECO HI TEMP OVERRIDE	0 sec	10 sec/0 – 9999	WRN
TEMP CTRL SENSOR FAIL	0 sec	3 sec/0 – 99999	ALM
HIGH DEW POINT	0 sec	30 sec/0 – 9999	WRN
LOW DEW POINT	0 sec	30 sec/0 – 9999	WRN
HI DEW POINT SENSOR A	0 sec	30 sec/0 – 9999	WRN
LOW DEW POINT SENSOR A	0 sec	30 sec/0 – 9999	WRN
HIGH REMOTE SENSOR	0 sec	30 sec/0 – 9999	WRN
POWER "A" FAILURE	0 sec	10 sec/0 – 9999	ALM
POWER "B" FAILURE	0 sec	10 sec/0 – 9999	ALM
AIRFLOW SENSOR FAILURE	0 sec	10 sec/0 – 9999	WRN
HUM CTRL SENSOR FAIL	0 sec	30 sec/0 – 9999	WRN

Table 4.2 Event Notification Defaults (continued)

Event	Internal Delay	Default Delay/Range for Adjustment	Type
LOSS OF FLOW	0 sec	5 sec/0 – 9999	ALM
DAMPER FAILURE	0 sec	10 sec/0 – 9999	ALM
BMS DISCONNECTED	0 sec	ENABLED/DIS - ENAB	WRN

Table 4.3 below, describes events available with a Liebert® MC Condenser.

NOTE: A CANbus connection between the Vertiv™ Liebert® MC condenser and Vertiv™ Liebert® iCOM™ is required to trigger these events.

Table 4.3 Events Specific to Liebert® MC Condenser

Event	Description
CAN GC 1 or 2	<ul style="list-style-type: none"> Vertiv™ The Liebert® iCOM™ board cannot establish communication with the Liebert® MC condenser board for 10 seconds consecutively. Alarm notification displayed for the corresponding circuit. EconoPhase pump operation disabled for the circuit affected. When Liebert® iCOM™ re-establishes communication with the Liebert® MC board, the event is reset.
GC 1 or 2 Rem Shutdown	<ul style="list-style-type: none"> Remote shutdown requested. Compressor(s) and EconoPhase pump(s) in the corresponding circuit are powered-off. If event occurs on the lead circuit, then the lead-lag order of the compressors/tandem banks changes. When the Liebert® MC condenser remote-shutdown circuit returns to inactive state (closed), the event is reset and the compressors in that circuit may be powered-on. Normal compressor lead-lag sequence resumes when both compressors are Off.
GC 1 or 2 Board Fail	An unrecoverable failure of the Liebert® MC condenser control board has occurred causing a condenser shutdown.
GC Pres Sens Fail C1 or C2	Condenser pressure sensor failure
GC High Cond Press C1 or C2	High condensing pressure
GC Low Cond Press C1 or C2	Low condensing pressure
GC 1 or 2 Amb Sens Fail	Ambient-temperature sensor failure
GC 1 or 2 Amb Temp Limit	High/low ambient temperature
GC Temp Sens Fail C1 or C2	Refrigerant-liquid-line temperature-sensor failure
GC High Cond Temp C1 or C2	High refrigerant liquid line temperature

Table 4.3 Events Specific to Liebert® MC Condenser (continued)

Event	Description
GC Low Cond Temp C1 or C2	Low refrigerant liquid line temperature
GC 1 or 2 Fan 1 through 4 FAIL	<p>The following events may result from a fan failure alarm. Refer to the specific fan manufacturer's literature for troubleshooting information.</p> <ul style="list-style-type: none"> • VSD high link current • VSD drive error • VSD earth to ground fault • VSD electronics heat sink thermal overload • VSD hall failure • VSD IGBT failure • VSD line fault • VSD motor locked • VSD motor thermal overload • VSD phase failure • VSD-specific uncategorized alarm detected • VSD electronics high-temperature condition • VSD high link voltage • VSD low link voltage • RS-485 communications failure
GC 1 or 2 TVSS Failure	TVSS alarm

Table 4.4 below, describes events available with a Vertiv™ Liebert® EconoPhase.

Table 4.4 Events Specific to Liebert® EconoPhase

Event	Description
PB1 BOARD FAIL	<p>An unrecoverable failure of the pump control board has occurred. Pump shut down.</p> <ul style="list-style-type: none"> • Pump board must be rebooted to reset event.
PB1 CAVITATE SHUTDOWN	<p>Pump has cavitated and shut down.</p> <ul style="list-style-type: none"> • Event is reset when Vertiv™ Liebert® iCOM™ requests a new start-up.
PB1 IN PRES SENS FAIL	<p>Inlet refrigerant pressure sensor failure. Pump shut down.</p> <ul style="list-style-type: none"> • Event is reset when condition clears.
PB1 IN TEMP SENS FAIL	<p>Inlet refrigerant temperature sensor failure. Pump shut down.</p> <ul style="list-style-type: none"> • Event is reset when condition clears.
PB1 INV DATA SHUTDOWN	<p>Invalid data detected and pump shut down.</p> <ul style="list-style-type: none"> • Event is reset when Vertiv™ Liebert® iCOM™ requests a new start-up.
PB1 LO DIFF PRESSURE	<p>Pump differential pressure fell below a lower threshold and pump shut down.</p> <p>Event is reset when Liebert® iCOM™ requests a new start-up.</p>
PB1 LO OUTLET TEMP	<p>Pump outlet-refrigerant temperature fell below a lower threshold and pump was shut down.</p> <ul style="list-style-type: none"> • Event is reset when Liebert® iCOM™ requests a new startup.
PB1 OUT PRES SEN FAIL	<p>Outlet refrigerant-pressure-sensor failure. Pump shut down.</p> <ul style="list-style-type: none"> • Event is reset when condition clears.



Table 4.4 Events Specific to Liebert® EconoPhase (continued)

Event	Description
PB1 OUT TEMP SEN FAIL	Outlet refrigerant-temperature-sensor failure. Pump shut down. <ul style="list-style-type: none"> Event is reset when condition clears.
PB1 CAN DISCONNECTED	Liebert® iCOM™ lost CAN communications with pump board. Pump shut down. <ul style="list-style-type: none"> Event is reset when condition clears.
PB1 REMOTE SHUTDOWN	Remote shut-down requested. Pump shut down. <ul style="list-style-type: none"> Event is reset when condition clears.
PB1 STARTUP FAIL	Three pump start up attempts in a row have failed. <ul style="list-style-type: none"> Event must be reset manually.
PB2 BOARD FAIL	An unrecoverable failure of the pump control board occurred. Pump shut down. <ul style="list-style-type: none"> Reboot pump board to reset event.
PB2 CAVITATE SHUTDOWN	Pump has cavitated and shut down. Event is reset when Liebert® iCOM™ requests a new start-up.
PB2 IN PRES SENS FAIL	Inlet refrigerant-pressure-sensor failure. Pump shut down. <ul style="list-style-type: none"> Event is reset when condition clears.
PB2 IN TEMP SENS FAIL	Inlet refrigerant-temperature-sensor failure. Pump shut down. <ul style="list-style-type: none"> Event is reset when condition clears.
PB2 INV DATA SHUTDOWN	Invalid data detected and pump shut down. <ul style="list-style-type: none"> Event is reset when Liebert® iCOM™ requests a new start-up.
PB2 LO DIFF PRESSURE	Pump differential pressure fell below a lower threshold and pump shut down. <ul style="list-style-type: none"> Event is reset when Liebert® iCOM™ requests a new start-up.
PB2 LO OUTLET TEMP	Pump outlet refrigerant temperature fell below a lower threshold and pump shut down. <ul style="list-style-type: none"> Event is reset when Liebert® iCOM™ requests a new start-up.
PB2 OUT PRES SEN FAIL	Outlet refrigerant pressure sensor failure. Pump shut down. <ul style="list-style-type: none"> Event is reset when condition clears.
PB2 OUT TEMP SEN FAIL	Outlet refrigerant-temperature sensor failure. Pump shut down. <ul style="list-style-type: none"> Event is reset when condition clears.
PB2 CAN DISCONNECTED	Vertiv™ Liebert® iCOM™ lost CAN communication with pump board. Pump shut down. <ul style="list-style-type: none"> Event is reset when condition clears.
PB2 REMOTE SHUTDOWN	Remote shut-down requested. Pump shut down. <ul style="list-style-type: none"> Event is reset when condition clears.
PB2 STARTUP FAIL	Three pump start-up attempts in a row have failed. <ul style="list-style-type: none"> Event must be reset manually.
PB1 COMMUNICATE FAIL	Ethernet communications failure. Pump not shut down. <ul style="list-style-type: none"> Event is reset when condition clears. USB communications failure. Pump not shut down. <ul style="list-style-type: none"> Event is reset when condition clears.

Table 4.4 Events Specific to Liebert® EconoPhase (continued)

Event	Description
PB2 COMMUNICATE FAIL	<p>Ethernet communications failure. Pump not shut down.</p> <ul style="list-style-type: none"> Event is reset when condition clears. <p>USB communications failure. Pump not shut down.</p> <ul style="list-style-type: none"> Event is reset when condition clears.
PB1 COND TO PUMP TEMP	<p>Temperature variance from condenser 1 output to pump 1 input exceeds allowed parameters. Pump shut down.</p> <ul style="list-style-type: none"> Event is reset when Liebert® iCOM™ requests a new start-up.
PB2 COND TO PUMP TEMP	<p>Temperature variance from condenser 2 output to pump 2 input exceeds allowed parameters. Pump shut down.</p> <ul style="list-style-type: none"> Event is reset when Liebert® iCOM™ requests a new start-up.
MM Cycle Lock Out	<p>Vertiv™ Liebert® EconoPhase operating in Mixed Mode has failed to control cooling 10 times in 6 hours.</p> <ul style="list-style-type: none"> Mixed Mode operation is disabled until the event is manually reset.
PB Cycle Lock Out	<p>Liebert® EconoPhase in Pump Mode has failed to control cooling 5 times consecutively at full-pump-capacity temperature conditions.</p> <ul style="list-style-type: none"> EconoPhase operation is disabled until the event is manually reset.

4.4 Enabling the Audible Alarm Notification

1. Touch , then  > *Display Options* > *Display Properties*.
The UNIT DISPLAY panel opens.
2. Touch the *Alarm Buzzer Pattern* value, and select a pattern from the drop-down list.
 - Selecting *None* disables the audible notification.
3. Touch *Save* to save the property settings.
 - Touch *Cancel* to discard changes.

4.5 Remote Alarm Device and Customer Input Events

Remote alarm devices are various sensors and detectors outside the cooling unit that provide information about conditions and situations that may affect operation. Remote alarm devices (RAD) include smoke detectors, filter condition, valve status.

Included in the RADs option are up to four customer input events depending on cooling unit configuration. In some cases, two additional, optional customer input events are available. See [Setting Up Customer Input Events](#) on the next page .



RAD and customer input notifications are set in the same way as other events. See [Selecting Event Type and Setting Alarm/Warning Notification](#) on page 49 .

4.5.1 Setting Up Customer Input Events

Input devices must be wired to Terminal 24 through a dry contact to locations 50, 51, 55 and 56 for alarms 1 through 4 respectively, (For the terminal location, refer to the cooling unit electrical schematic and installation manual). **Table 4.5** below, maps the customer input to the RADs

Table 4.5 Customer Input Terminals to RAD Terminals

Customer Input	Customer Input Terminal	RAD Number	RAD Terminal
1	24	1	50
2	24	2	51
3	24	3	55
4	24	4	56

1. Touch , then  > *Alarm/Event Setup* > *Remote Alarm Device Input*. The EDIT panel opens.
2. In *Customer Input X* (where X is the input number), select the input type that best describes the wired device/input, see **Table 4.6** on the facing page .
3. In *Customer Input X Active When*, select whether the input is active (triggers events) when *Opened* or *Closed*.
4. Once input(s) are set, touch *Save*.
The customer-input settings are saved.

Customer Input Options

Customer Input X

Selects the customer wired input, where X is the input number. See **Table 4.6** on the facing page, for a description of available values.

Customer Input X Active When

Selects when the input triggers an event. Options are:

- Opened: Events are triggered when the contacts across the corresponding RAD terminal strip are open.
- Closed: Events are triggered when the contacts across the corresponding RAD terminal strip are closed.

NOTE: Depending on customization, some events listed in Table 4.6 below , may not be available with your system.

Table 4.6 Customer Input Options

Input	Action/Description
Smoke	Event only.
Water Alarm	Event only.
C PMP Alarm	Event only.
Flow Alarm	Event only.
Stdby G Pmp	Event only.
Stdby Unit	Event only.
C-Input 1	Event only.
C-Input 2	Event only.
C-Input 3	Event only.
C-Input 4	Event only.
Rht Lockout	Event + Electric heaters disabled.
Hum Lockout	Event + Humidifier disabled.
Rht+Hum Lock	Event + Electric heaters and humidifier disabled.
Comp Lockout	Event + Compressor(s) disabled w/o pump down.
Call Service	Event only.
High Temp	Event only.
Air Loss	Event only.
FC Lockout	Event + Free-cooling disabled.
Heater Alarm	Event + Heaters off.
Flow AL SD	Event + Shut-down the unit.
Flow AL LC	Event + Lockout compressors, no pump down. (Enabled only if at-least one compressor is operating. Auto-reset depends on input status.)
Comp Lock PD	Event + Compressor(s) disabled w/ pump down
Enable FC	Forces free-cooling to "On."
HTRJ VFD	Activates the HEAT REJ VFD ALARM. No other function.
HTRJ SPD	Activates the HEAT REJ SPD ALARM. No other function.
FIRE ALARM	Event + Shuts-down the unit.
2ND SETPOINT	No event, but switches to the second setpoint.
Emergency Power	Event + Disables unit.
LSI	Event + Activates humidifier-problem Alarm and stop filling bottle when full.
COND 1 FAIL	Event only.
COND 2 FAIL	Event only.
D-SCROLL RED	Event + Reduces requested compressor capacity by 20%.
SWAP VALVE	No event -Active X valve closes and Y opens/Inactive Y closes and X opens. See 7.3 - Custom Dual Chilled Water Valve

Table 4.6 Customer Input Options (continued)

Input	Action/Description
	Staging.
EC FAN FAULT	Event + Set analog output to 10 V.
ECO AIRFLOW	Event + Reduce Vertiv™ Liebert® Air Economizer air flow.
DAMPERSWITCH	Damper + End switch.
POWER A	Event only.
POWER B	Event only.

5 Unit to Unit Networking

NOTE: Your Vertiv™ Liebert® DSE Packaged Solution does not offer humidification or dehumidification functions. Please disregard those settings/fields when mentioned in this guide or displayed on the Vertiv™ Liebert iCOM™ controller.

Liebert® iCOM™ controlled thermal management units connected in an Ethernet unit to unit (U2U) network are able to efficiently cool and control humidity in the conditioned space by exchanging data in several modes of operation.

U2U networking is required to set up and control the following operating features:

- Teamwork
- Stand-by (lead/lag)
- Rotation
- Cascading

NOTE: The U2U network must be separate from other networks. Use a communication card, such as a Vertiv™ Liebert® IntelliSlot Unity, to communicate securely between your building-management system or other networks.

5.1 Preparing for U2U Group Set Up

Cooling units in the network will be assigned to groups, which affects how units function in teamwork, standby, rotation, and cascading operations. Especially in large rooms, it is important to consider several factors before setting up groups to balance cooling unit operation with room conditions.

NOTE: For ease of set-up and use, we recommend using only one group unless you have multiple rooms, differing software versions, or different types of cooling units.

1. Make a map of the room and indicate the location of all heat generating devices and cooling units to plan for proper heat load management and cooling air distribution.
2. Note the type of units by product/model, size, etc.
3. Determine the number of units to network together to ensure proper air flow and environmental control, up to 32 units.
4. Determine number of standby units.
5. Determine if using teamwork and if so, which mode.
6. Plan U2U address assignments.
 - Refer to the [U2U Display and Control Board Settings](#) on page 61, for guidelines assigning cooling-unit control-board addresses and Vertiv™ Liebert® iCOM™ display board addresses.
 - Balance/alternate unit address assignments based on room layout and because standby and teamwork operate in numeric order by unit number. **Figure 5.1** on the next page, shows an example layout assignment with half of the cooling units in stand-by and half operating. Without a plan, adjacent units could be operating or inactive, which may not provide proper heat-load balance or efficient use of cooling capacity.

7. Read and record all programmed settings for each of the individual units (see [Backing Up, Importing, Exporting, and Restoring Display Settings](#)).
8. Verify that network cabling and switches are provided, ready to connect, and labeled by unit at the network switch.

NOTE: Cooling units are factory wired for stand alone operation. Do not connect the U2U network cabling before setting the U2U network configuration/groups. Network communication conflicts and unreliable display readings will result. Configure the network using [Configuring U2U Network Settings](#) on the facing page , then refer to [U2U Wiring Connection](#) on page 162 , to connect the network cabling and hardware.

Figure 5.1 Example Layout Standby/Operating Unit Address Assignment

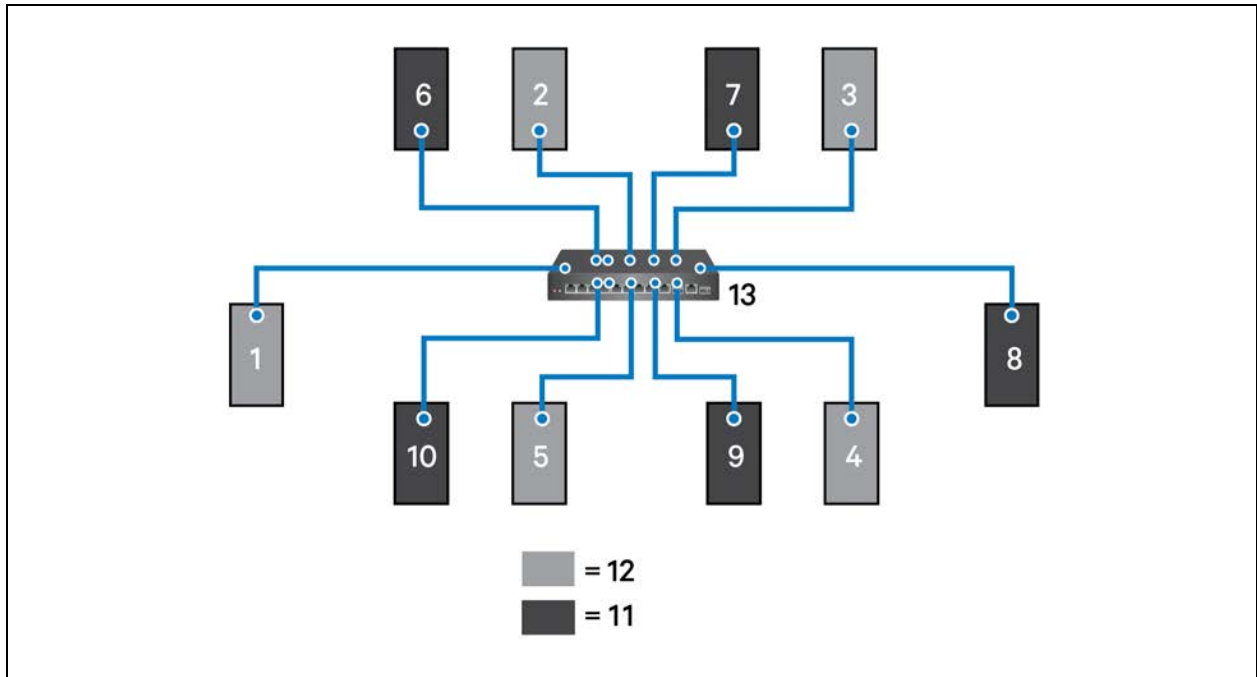

Item	Description
1 to 10	Assigned address of the thermal-management unit.
11	Operating units.
12	Units on standby.
13	Network switch.

5.2 Configuring U2U Network Settings



NOTE: Always change and save the control board settings first. If you change the display settings first, you could lose access to the control board via Vertiv™ Liebert® iCOM™.

The U2U NETWORK SETTINGS configure Liebert® iCOM™'s unit to unit communication and includes information buttons,



that display pop-up field descriptions. The panel also indicates issues with the network settings. For resolution, see [Troubleshooting Network Settings Issues](#) on page 63.

5.2.1 To Configure Unit to Unit Networking

1. Touch , then  > *BMS & Teamwork Setup* > *U2U Setup*. The U2U NETWORK SETTINGS panel opens.
2. Touch the field to edit. The keypad opens.
3. Type the entry and touch . When all fields to edit are updated, touch *Save & Restart*.

NOTE: Depending on the changes made, the Save button updates to indicate the components that need rebooted or restarted. If the control board reboots, the cooling unit suspends operation for 60 seconds, then resumes operating.

5.2.2 U2U Display and Control Board Settings

Broadcast

Logical address at which connected units receive datagrams.

NOTE: Messages sent to the broadcast address is typically received by all network-attached hosts.

CB Firmware Version

Display configuration based on the firmware version of the control board. Depends on your cooling unit as follows:

- CR-2.03 = CRV
- PA-2.01 = CW/DS
- PA-2.04 = DSE
- PA-2.05 = DSE, PDX/PCW, Mini-Mate
- PA-2.06 = CW/DS, DSE, PDX/PCW, Mini-Mate

NOTE: CB Firmware Version does not alter or affect the firmware running on the control board. It only updates the display configuration. If incorrect, menus and data in the Vertiv™ Liebert® iCOM™ display will be invalid or missing.

Gateway

Routes data and acts as proxy server/firewall for display and control board during network set-up.

Generate U2U Compatible Broadcast

Facilitates U2U communication between the display and control board.

NOTE: Do not uncheck. Failure to generate the compatible broadcast address results in loss of communication between the display and control board.

IP Address

Network address of the display and control board.

NOTE: Last 3 digits must be a unique value and need not be sequential. However, we recommend that they match the U2U address for easier reference later.

Netmask

Divides IP addresses in subnet and specifies network available to hosts for the display and control board. Display and control-board Netmask must be identical on the U2U network.

MAC Address

Unique, read-only identifier of the display or control-board Ethernet device.

U2U Address

For the display, a unique identifier for each display on the U2U network. Address range is 33 to 64.

For the control board, a unique identifier for each control board on the U2U network. Address range is 1 to 32 and must be consecutive from the previous control-board address in the U2U group. This is the address used for stand-by/lead-lag and cascade operation, see **Figure 5.1** on page 60 .

NOTE: For both board and display, we recommend matching the U2U address to the last 3 digits of the IP address for easier reference later.

U2U Group

For the display, select the zone/group to which the unit belongs.

For the control board, selects the zone/group with which the unit will be configured in teamwork/stand-by/rotation scenarios.

NOTE: Units with a specific thermal area of influence should be assigned to the same zone/group, typically when a network spans separate rooms rather than by aisles. Groups are also handy when cooling units vary by cooling type, compressor type, or version of Vertiv™ Liebert® iCOM™ firmware and otherwise do not operate together efficiently or at all.

U2U Target Address

The address of the control board targeted by the display.

- The unit's U2U target address must match the control -board U2U address.

5.2.3 Troubleshooting Network Settings Issues

At the bottom of the U2U NETWORK SETTINGS panel, an Issues button indicates whether or not there are problems with the network settings. The button indicates the number of issues and changes color when a problem exists, see **Table 5.1** below .

Table 5.1 Issues Button Status Colors



Color	Description
Green	No problems. Number of issues is zero.
Red	Problem(s) detected. Number of issues displays.

To view network issues:

1. When an issue is indicated, touch the Issues(s) button on the U2U NETWORK SETTINGS panel. The ISSUES dialog opens.
2. Note the problems and *Close* the dialog, then address the issue:
 - Touch the setting to correct. The on-screen keyboard opens.
 - Make adjustments and touch *Go*.
 - Continue making corrections until no problems are indicated.
3. Verify that unit-to-unit communication is established, then touch *Save*.

NOTE: Depending on the changes made, the Save button updates to indicate the components that need rebooted or restarted. If the control board reboots, the cooling unit suspends operation for 60 seconds, then resumes operating.

5.2.4 Modifying U2U Network Settings

1. Touch  , then  > *BMS & Teamwork Setup* > *U2U Setup*. The U2U NETWORK SETTINGS panel opens.
2. Touch the setting to edit and make adjustments, then touch .
3. Verify that unit to unit communication is established, then touch *Save*.

NOTE: Depending on the changes made, the Save button updates to indicate the components that need rebooted or restarted. If the control board reboots, the cooling unit suspends operation for 60 seconds, then resumes operating.

This page intentionally left blank

6 Teamwork, Standby and Rotation for Cooling Units

NOTE: Your Vertiv™ Liebert® DSE Packaged Solution does not offer humidification or dehumidification functions. Please disregard those settings/fields when mentioned in this guide or displayed on the Vertiv™ Liebert® iCOM™ controller.

Liebert® iCOM™ unit to unit communication via private network and additional hardware allows the following operating features for the cooling units. (See [Unit to Unit Networking](#) on page 59)

- Teamwork
- Standby (Rotation)
- Cascade

6.1 Continuous Control with Virtual Master

The Virtual Master function maintains smooth control if group communication is compromised. In these operating configurations, a lead (master) unit is in charge of component staging in teamwork mode, unit staging, and stand-by rotation. If the lead unit gets disconnected, Vertiv™ Liebert® iCOM™ automatically assigns a virtual master, which assumes the responsibilities of the lead unit until communication is restored.

6.2 Teamwork Modes

When Vertiv™ Liebert® iCOM™ controlled thermal management units are connected to a network in a group or team, use teamwork to optimize performance and efficiency depending on the mode chose and its application.

In a panel with Status content, the Teamwork mode icon indicates the mode selected, **Figure 6.1** on the next page . Touching the icon displays the Teamwork dialog from which you can access the teamwork control settings.

6.2.1 To Set Up Team Work

1. Touch the Teamwork-mode icon, then touch *Edit* on the teamwork dialog.
– or –



Touch , then  > *BMS & Teamwork Setup* > *Teamwork / Standby* > *TeamworkMode*.

2. Select the mode from the *Teamwork Mode* drop down in the TEAMWORK MODE CONTROL panel. The TEAMWORK/STANDBY panel opens.
3. Touch *Save*. Teamwork mode is set.
 - Touch *Cancel* to discard changes.

Figure 6.1 Teamwork Icons

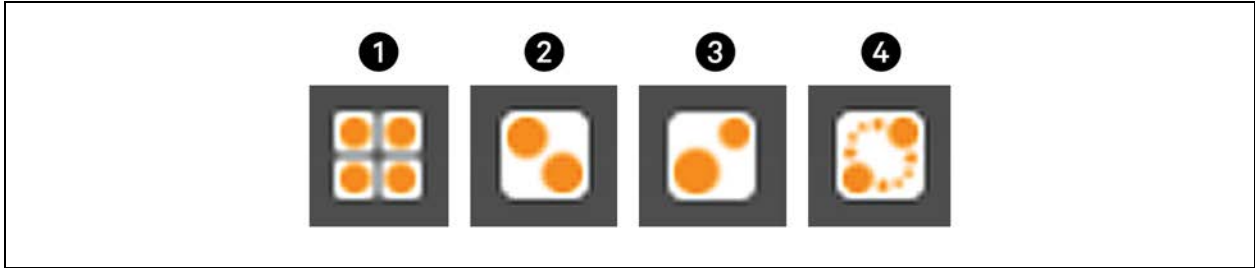

Item	Description
1	No teamwork.
2	Mode 1 - Parallel teamwork
3	Mode 2 - Independent teamwork
4	Mode 3 - Optimized aisle teamwork

NOTE: Depending on the type of thermal management unit, included components, and control settings of your system, all of the options listed may not be available on your Vertiv™ Liebert® iCOM™ display.

Teamwork Control Options

Cascade Units

Stages on stand-by units based on room temperature/humidity load. Available in Teamwork modes 1 and 3, the options differ for each:

- Teamwork mode 1. Parallel options are:
 - Yes: Standby units cascade on based on a call for heating, cooling, humidification, or dehumidification.
 - Cool/Heat: Standby units cascade on with a call for heating or cooling only.
 - Cooling: Standby units cascade on with a call for cooling only.
- Teamwork mode 3 - Optimized Aisle options are:
 - Fan PI: Standby units cascade on based on the inability of active units to reach setpoint temperature or if using static pressure control, setpoint pressure while operating at full capacity.
 - Fan speed: Standby units cascade on based on the inability of active units to reach setpoint temperature or if using static pressure control, setpoint pressure while operating at full fan speed.

Cascaded Units Delay

Length of time in minutes to delay the activation of a stand-by unit after the previously activated unit starts, to prevent staged cascaded units from starting too close together or at the same time.

Cascaded Units Min Run

Length of time in minutes that an cascade on unit must run before powering-off.

Cascaded Units Off Delay

Length of time, in minutes, to delay powering-off a cascaded unit after fan speed drops below the *Stop Next Unit @ SYS Fanspeed* setting.

Cascaded Units Quick Start

After a power cycle of the master unit, identical to Cascaded Units Delay except that it should be shorter to get units to start more quickly after a power cycle.

- This delay remains in effect until all cascaded units have been restarted, then the delay reverts to setting of Cascaded Units Delay.

Max. Intermediate System Speed

Limits the fan speed of the group until all units in cascade are powered on. Once all units are operating, the fan speed may increase beyond this setting.

Number of Connected Units

Number of units connected in the group if U2U networked.

Start Next Unit at SYS Fanspeed

Fan speed at which the next cascaded unit is powered-on.

Stop Next Unit at SYS Fanspeed

Fan speed at which the next cascaded unit is powered-off. Unit power-off may be delayed by *Cascaded Units Off Delay*.

Based On

Select the way the sensor readings from each cooling-unit in the group are used to control temperature and humidity.

Options are:

- Maximum: Based on the highest reading from a sensor in the group.
- Average: Based on the average readings from the sensors in the group.

Type

Teamwork mode to use for the group.

6.2.2 No Teamwork—Multiple Zones in One Room

When a teamwork mode is not used, cooling units work independently based on their own sensors. Standby and unit rotation may be used, but cascading cannot.

6.2.3 Teamwork Mode 1—Parallel Operation

In Teamwork mode 1, fan speed and cooling capacity are ramped-up in parallel, which means that all units operate identically.

Teamwork mode 1 is best for small rooms with balanced heat loads. A master unit collects the controlling readings for temperature and humidity from all the operating (fan on) units in the group, then determines the average or worst-case reading, and sends operating instructions to efficiently distribute cooling capacity across available units.

In Teamwork mode 1, most parameters are shared and, when set in any unit, are set in all units in the group.

6.2.4 Teamwork Mode 2—Independent Operation

Teamwork mode 2 works well for most applications, and best in large rooms with unbalanced heat loads by preventing units in a group from operating in opposing modes, some cooling and some heating. All temperature and humidity parameters are shared by the group. The master unit monitors all available unit-sensor readings and determines the demand for cooling, heating, humidification and dehumidification, then sends operating instructions to address the greatest demand.

In Teamwork mode 2, the setpoints for all units must be identical. The proportional band, deadband, and related settings may differ by unit. Fan speed is modulated per unit. Rotation and cascading is not available, so expect uneven distribution of work hours.

6.2.5 Teamwork Mode 3—Optimized Aisle Operation

In Teamwork Mode 3, the fan speed for all units operates in parallel, which means fan speed operation is identical at each unit. However, cooling capacity operates independently for each unit.

Teamwork mode 3 takes advantage of variable speed fan options and variable-capacity component options to maintain rooms with an unbalanced load and to prevent units in a group from operating in opposing modes. All units operate in the same mode based on the average or worst-case (maximum) readings from the unit sensors. A local control (cooling capacity supply sensor) provides input to manage and maintain the discharge air temperature at each unit. In addition, fan speed and operation are controlled based on readings from the unit temperature or static pressure sensors to control air delivery to the cold aisle.

NOTE: Stand-by and lead/lag are available when using optimized aisle mode, but is not recommended because it requires less power to run all units at reduced capacity.

Setting Up Teamwork Mode 3



Teamwork mode 3 requires the following:

- Vertiv™ Liebert® iCOM™ connection to a U2U network.
- Variable capacity compressors in the cooling unit.
- Variable speed fans in the cooling unit.
- Supply control air temperature sensors.



In addition, specific settings for wired remote (rack) sensors and setpoints are needed as described in the following steps.

To Set Up Optimized Aisle Operation



1. Set wired remote sensor function and mode:



- Touch , then  > *Auxiliary Device Setup* > *Sensors* > *Wired Remote Sensors*.
- Touch each sensor name, and select *Control* or *Reference* in *Function* based on rack setup or preference, then touch *Save*.
- On the SENSORS panel, touch *Setup* under *Wired Remote Sensors*, and select *Maximum* or *Average* in *Unit Remote Sensors Mode*, then touch *Save*. See [Wired Remote Sensors](#) on page 122, for descriptions of all the wired remote sensor settings.

2. At each unit in the group:

- Touch , then  > *Setpoints* > *Temperature Control*.
- In *Temperature Control Sensor*, select *Supply Sensor*, then touch *Save*.
- In *Temperature Setpoint*, select the setpoint based on the cooling unit's area of influence, then touch *Save*.

3. At the master unit:

- Touch , then  > *Setpoints* > *Fan Control*.
- In *Fan Control Sensor*, select *Remote Sensor*, then touch *Save*.
The other units in the group are set automatically.

- Touch , then  > *BMS & Teamwork Setup* > *Teamwork / Standby* > *Teamwork Mode*.
- In *Teamwork Mode*, select *3 Optimized Aisle*.
- In *Teamwork* is based on, select *Maximum* or *Average*, then touch *Save*.

Teamwork mode 3 is set.

4. Monitor operation of the cooling units and adjust setpoints and control bands as necessary.

6.3 Assigning Cooling Units to Standby (Lead/Lag)

Stand-by assigns some units to operate while others are on standby, which is idle but ready to become active in the event of an alarm condition in one of the operating units or based on a rotation schedule.

When a unit is in standby mode, fan(s) are off and no cooling occurs. In multiple cooling unit systems, assigning units to standby lets you:



- Configure redundancy in case of failure scenarios (stand-by).
- Manage cooling unit run time (lead/lag). See [Setting a Rotation Schedule](#) on the next page.
- Modulate for very low loads to full-design load (to be temperature reactive) by cascading activation of standby units (configured when setting-up teamwork mode).

The U2U network has built in fail over conditions that are automatically employed when standby units have been assigned:

- During single cooling-unit or component failure, a standby unit is activated to replace the failed unit.
- Alarm event causes unit shutdown, a stand-by unit is activated. If the activated unit also has an alarm event, the next available stand-by unit is activated. If all units have an alarm event, and no more stand-by units are available, a unit with a non-critical alarm event will be activated.

NOTE: Redundancy is employed if units are assigned to standby regardless of the teamwork mode selected, including no teamwork.

6.3.1 To Set up Lead/Lag Operation

1. Touch , then  > *BMS & Teamwork Setup > Teamwork / Standby*. The TEAMWORK/STANDBY panel opens.
2. Touch *Standby*. The STANDBY CONTROL panel displays.
3. Adjust the settings, then touch *Save*.
 - Touch *Cancel* to discard the changes.

Standby Options

High Temperature Threshold

Temperature at which all standby units are activated.

Number of Standby Units

Number of units in standby mode.

Standby Fan Timer at Reheat/Humidification



Length of time in minutes that the fan continues to operate after the cooling unit enters standby or sleep mode if reheat or the humidifier were operating when unit powered off.

Start All Standby Units by High Temperature

When enabled, all units are activated to cool when a high temperature alarm occurs.

6.4 Setting a Rotation Schedule

You can set a rotation schedule to switch operating and standby units to manage run time of the cooling units.

1. Touch , then  > *BMS & Teamwork Setup > Teamwork / Standby*. The TEAMWORK/STANDBY panel opens.
2. Touch *Unit Rotation*. The UNIT ROTATION CONTROL panel displays.
3. Adjust the settings, then touch *Save*.
 - Touch *Cancel* to discard the changes.

6.4.1 Unit Rotation Options

Lead Lag Overlap Timer

Length of time in minutes that cooling units operate in parallel when one begins operating (from standby) and the other goes into standby.

Rotate At

Selects exact time at which rotation occurs. Adjustable, based on a 24 hour clock where minutes are 0 to 59 and hours are 0 to 23.

Rotate By

Number of positions by which the cooling units rotate. For example, rotate by 3 in a group of 10 units and start with unit 1 operating. At rotation, unit 1 goes to standby and unit 4 activates, then 7, 10, 2, and so on. You can select 1 to 8 units in a single rotation schedule.

Rotate Every

Selects rotation period. Valid values:

- 12 hrs
- 24 hrs

Rotate Now

Immediately performs rotation.

Rotation Frequency

Frequency at which rotation occurs. Options include:

- No: Rotation disabled.
- Daily: Rotation occurs every day.
- Every [Day of Week]: Rotation occurs weekly on the same day.
- Monthly [Day of Week]: Rotation occurs monthly on the same day.



6.4.2 Manually Rotating the Operating and Standby Units

You can rotate the operating and standby units outside of the set schedule using Rotate Now.

NOTE: Manual rotation may only be performed at the cooling unit designated as the lead unit, U2U Address = 1, of the group.



NOTE: The Rotate Now button may only be available when a Rotation Frequency is selected. See [Setting a Rotation Schedule](#) on the previous page .

1. At the cooling unit, verify that it is the lead unit of the group:

- Touch , then  > *BMS & Teamwork Setup > U2U Setup*.
- In the CONTROL BOARD column, verify that the *U2U Address* is **1**.

If it is the lead unit, continue with step 2.

If it is not the lead unit, find the lead unit and start at step 1.

2. Touch , then  > *BMS & Teamwork Setup > Teamwork / Standby*. The TEAMWORK/STANDBY panel opens.
3. Touch *Unit Rotation*. The UNIT ROTATION CONTROL panel displays.
4. Touch *Rotate Now*, then touch *Save*. The operating and standby units are rotated.

7 Configuring Economizer Operation

NOTE: Your Vertiv™ Liebert® DSE Packaged Solution does not offer humidification or dehumidification functions. Please disregard those settings/fields when mentioned in this guide or displayed on the Vertiv™ Liebert® iCOM™ controller.

Use Liebert® iCOM™ to configure the economizer installed on your cooling unit.

NOTE: Depending on customization to your cooling system, one of two types of economizer may be installed, Vertiv™ Liebert® Fluid Economizer or Vertiv™ Liebert® Air Economizer. Menu options differ depending on the type of economizer installed and significant differences are noted when they occur.

7.1 Fluid Economizers

Fluid economizers provide a secondary chilled water or glycol coil (Vertiv™ Liebert® Econ-O-Coil) for cooling. Economizer operation is commonly referred-to as free cooling because it reduces or eliminates the use of the compressor(s) in the right environmental conditions.

Your system may have one of two kinds of fluid economizers:

- GLYCOOL Economizer: a two pipe system that feeds a second glycol coil in the cooling unit and also the compressor(s) and heat exchanger (Vertiv™ Liebert® Paradenser™, tube-in-tube condenser, or brazed plate heat exchanger).
- Dual-Cool Economizer: A two pipe or four pipe system.
 - A two pipe system provides chilled water to a second coil, bypassing the air cooled/condenser compressorized loop.
 - In a four pipe system, two fluid lines are dedicated to a second chilled-water coil and two fluid lines are dedicated to a glycol cooled or chilled water cooled compressorized loop.

The Fluid Economizer option appears on the Vertiv™ Liebert® iCOM™ Service menu and opens the FLUID ECONOMIZER panel to configure operation.

7.1.1 Fluid Economizer Control Options

Override

Configures cooling unit override of economizer operation. See [Overriding Fluid Economizer Operation](#) on the next page .

Setup



Configures the activation setpoints of the economizer. See [Setting Up Fluid Economizer Operation](#) on the next page .

Status

Status of economizer properties. See [Viewing Fluid Economizer Statuses](#) on page 79 .

7.1.2 Overriding Fluid Economizer Operation

Overrides the economizer’s settings with those of the cooling unit.

1. Touch , then  > *Economizer* > *Override*. The OVERRIDE panel opens.
2. Select the override settings and touch Save.

Fluid Economizer Override Options

Enable Fluid Economizer

Enables/disables economizer operation.

Lockout FC at FC Fluid below



When enabled, prevents frost on free cooling pipes by disabling the free-cooling unit when the FC Fluid Temperature falls below the specified limit. The default setting is 32°F

Stop FC at Setpoint + Value

Temperature at which free cooling is locked out.

7.1.3 Setting Up Fluid Economizer Operation

Configures activation points of the economizer. The sensors used to control/activate secondary cooling are room/local air temperature sensor or return air sensor and an Aquastat Sensor (AQ) that measures the glycol/chilled water temperature.

1. Touch , then  > *Economizer* > *Setup*. The SETUP panel opens.

Indicator dots next to the parameters show the status of the property. **Table 7.1** below, describes the color dots that indicate whether or not DT Between Room and Fluid Value (depending on the selection for DT Between Room and Fluid Value) is within range for economizer operation. Indicators must be green to condition the space using the economizer. If an indicator is yellow, the economizer will not condition the space.

2. Refer to the [Fluid Economizer Set Up Options](#) on the facing page, and [Temperature Control with a Fluid Economizer](#) on page 76, to adjust the setpoint options, then touch Save.

Table 7.1 Economizer Property Status Indicators

Indicator color	Definition
Green	The air or fluid meets the requirements for use.
Yellow	The air or fluid does not meet requirements and is ineligible for use.

NOTE: Depending on the type of economizer with your system, all of the options listed may not be available on your Vertiv™ Liebert® iCOM™ display.

Fluid Economizer Set Up Options

DT Between Room and Fluid Type

Selects the glycol/chilled water temperature input used by the comparator circuit to determine if the differential temperature (DT) warrants use of secondary cooling.

- **Disabled:** Disables the second cooling source in dual cool configurations and is the default setting for standard, compressorized units and for chilled-water units without a second cooling source.
- **Contact:** An external input is used to determine secondary cooling activation based on the open/closed status of the contact:

Open: Activate second cooling source.

Closed: Deactivate second cooling source.

- **Temp:** The difference between the fluid temperature and the room air temperature (Temperature Setpoint) determines use of secondary cooling. (The difference parameter is set with the DT Between Room and Fluid Value slider. When the difference is equal to or greater than the selected value, secondary cooling is used.)
- **Set:** Enables free cooling when the sensed fluid temperature is colder than the Temperature Setpoint. (The difference parameter is set using the DT Between Room and Fluid Value slider. When the difference is equal to or greater than the selected value, secondary cooling is used.)

DT Between Room and Fluid Value

Temperature difference between fluid and room air at which secondary cooling activates. For example, when set at the factory default 12°F (-11.1°C), secondary cooling activates when the fluid temperature is 12 or more degrees colder than the room air temperature/setpoint.

Minimum CW Temp

Enables/disables setting a minimum chilled water temperature that controls simultaneous operation of chilled water secondary cooling and compressor(s).

Minimum CW Temp Value

Temperature of the fluid that determines whether or not secondary cooling and compressor(s) operate simultaneously:

- If the fluid temperature is below the minimum temperature and if the temperature differential is satisfied (DT Between Room and Fluid Value), then the compressor(s) are locked-out and the secondary chilled water coil provides cooling.

NOTE: If secondary cooling fails (for example, loss of water flow), this setting is overridden and the compressor(s) activated. If this occurs, free cooling is locked out for one hour.

- If the fluid temperature is above the minimum temperature, chilled-water and the compressorized cooling will operate simultaneously if needed.

Enable Free Cooling Flush

Number of hours between flushes of the free cooling coil.

Free Cooling Flush Duration

Length of time the for flush of the free cooling coil.

Free Cooling Flush Starts K11

When enabled, the Q15 relay is activated during the free cooling flush.

Ramp Up Fan at 100% FC

Enables/disables and increase in fan speed when free cooling reaches 100% capacity.

7.1.4 Temperature Control with a Fluid Economizer

When an economizer is installed, the cooling requirement (determined by the temperature proportional band) is addressed first by the economizer's secondary cooling, if the economizer cooling capacity is insufficient, the compressor(s) begin cooling to bring the room air temperature down to the temperature setpoint.

The fluid economizer employs a motorized ball valve that controls the flow of chilled water/glycol to provide a cooling capacity from 0% to 100%.

Simultaneous Operation, Partial Economizer Operation, Staging Cooling Sources

When simultaneous operation of the compressor(s) and secondary cooling is enabled, the portion of the proportional band assigned to the fluid capacity valve may be reduced by the comparator circuit based on the differential temperature (DT) settings. When this occurs, the compressor-control proportional band moves closer to the setpoint, and compressorized cooling begins before secondary cooling reaches 100% (as shown in [Secondary Cooling Temperature Control with 2-Step Compressor](#) on the facing page) or shuts off.



CAUTION: On units with a GLYCOOL fluid economizer and standard scroll or semi-hermetic compressors without unloaders, there is a risk of over-cooling and low refrigerant pressure when free cooling/secondary cooling operates simultaneously with compressor/DX cooling. Make sure adequate flow is provided when 100% free cooling and compressorized cooling occur at the same time. If the fluid temperature is too cold while the compressors are running, the refrigerant pressure will drop. Contact technical support at 1-800-543-2778 for more information on setting-up simultaneous operation.

NOTE: The compressor control method is not affected by economizer operation and operates across the assigned proportional band based on the compressor configuration of your system (1-step, 2-step, 4-step, or digital-scroll). See [Compressor Control by Cooling Requirement](#) on page 23 , for a description compressor-control methods.

Secondary Cooling Temperature Control with 2-Step Compressor

When the fluid temperature meets the set up requirements, secondary cooling provides temperature control as follows. If the fluid is not cold enough, primary, compressorized cooling operates as normal.

NOTE: The compressor control method is not affected by economizer operation and operates across the assigned proportional band based on the compressor configuration of your system (1-step, 2-step, 4-step, or digital-scroll). See Compressor Control by Cooling Requirement on page 23 , for a description compressor-control methods.

- 70° temperature setpoint
- 8° temperature proportional band
- 2° temperature deadband

In **Figure 7.1** on the next page :

The proportional band is divided evenly on each side of the setpoint, and an additional half of the proportional band is added to the cooling side for 200% cooling.

- At 71° air temperature (cooling demand 0%), the fluid control valve is closed.
- As cooling demand increases from 0% to 100%, the fluid control valve opens incrementally to increase cooling capacity proportionally until fully open at 75° (cooling demand 100%).

NOTE: If simultaneous operation of economizer cooling and compressor (DX) cooling is enabled, the compressor(s) may begin operation before the valve is open 100% because the fluid temperature differential is calculated to provide insufficient cooling.

- At 100% cooling demand, the compressor control method is employed across the additional half of the proportional band, a single scroll compressor with unloaders in this example:
 - The compressor starts unloaded at 77° when the cooling requirement is 150%.
 - At 79° when the cooling requirement is 200%, the compressor operates loaded until 77° is reached when cooling requirement is 150% when it returns to unloaded operation.

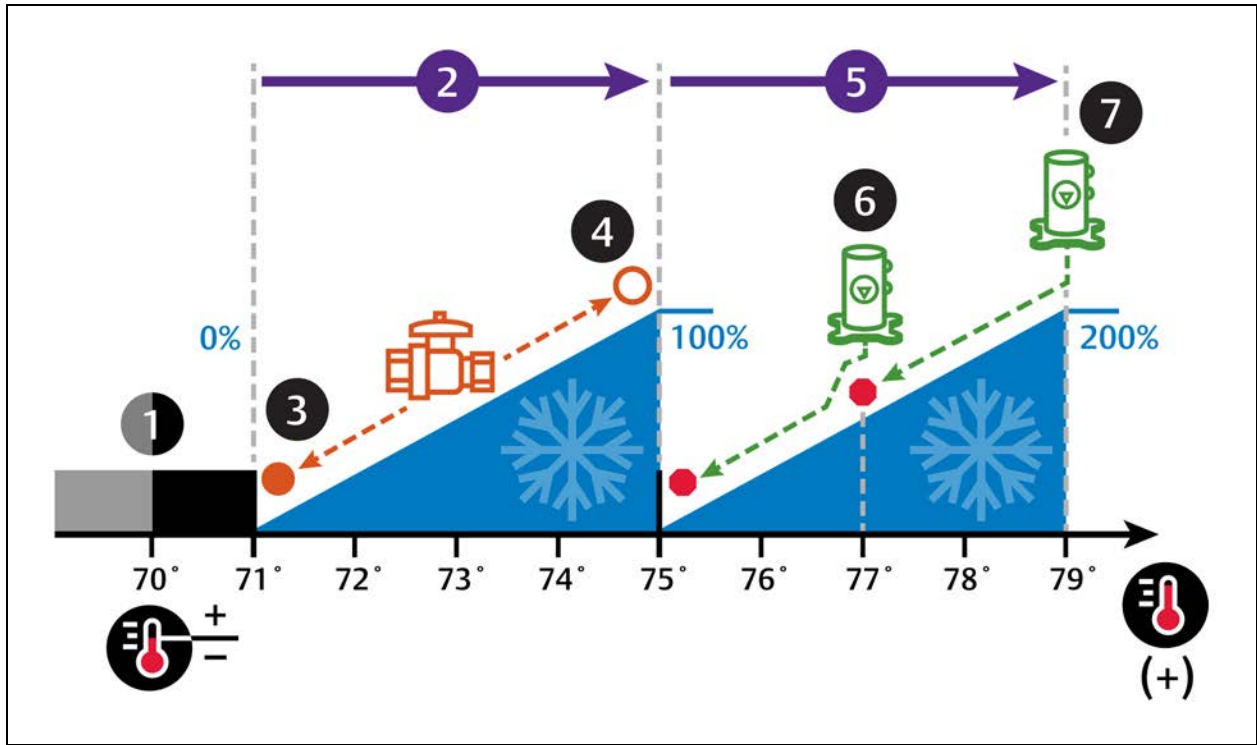

Figure 7.1 Temperature Control—Fluid Economizer and Example 2-Step Compressor Capacity



No.	Description	No.	Description
1	Deadband.	5	½ of proportional band assigned to compressor(s) operation.
2	½ of proportional band assigned to valve operation.	6	Scroll compressor step 1. (Compressor 1 in dual-compressor configuration, Unloaded in single-compressor configuration.)
3	Fluid control valve closed.	7	Scroll compressor step 2. (Compressor 2 in dual-compressor configuration, Loaded in single-compressor configuration.)
7	Fluid control valve fully-open.		

7.1.5 Viewing Fluid Economizer Statuses

Display the status of the economizer features installed in the cooling unit.

- Touch , then  > *Economizer* > *Status*. The STATUS panel opens.
 - If the status indicators are not all green, the economizer is not used to condition the unit. To adjust the settings, see [Setting Up Fluid Economizer Operation](#) on page 74 .

Fluid Economizer Status Options

FC Capacity

Cooling capacity of the fluid economizer.

Free Cooling Fluid Temperature

Current temperature of the free cooling fluid.

This page intentionally left blank

8 External Monitoring and Building Management Systems

Vertiv™ Liebert® iCOM™-controlled cooling units are equipped with embedded Vertiv™ Liebert® IS-Unity-DP software to communicate with external monitoring systems including Building Management Systems (BMS), Network Monitoring Systems (NMS) and Vertiv™ Liebert® SiteScan™ Web.

Embedded Unity communicates with multiple third-party protocols to monitor and manage a range of parameters and events. The Embedded Unity software delivers:

NOTE: Because the Liebert® iCOM™ U2U network must be separate from other networks, use external monitoring or BMS to communicate securely between networks.

- Velocity Protocol for Vertiv™ Liebert® *Trellis*™, Liebert® SiteScan™ and Vertiv™ Liebert® Nform.
- Embedded Vertiv™ Liebert® LIFE™ Technology for Remote Service Delivery.
- SNMP (v1/v2/v3) for NMS.
- HTTP/HTTPS for web page viewing.
- SMTP for e-mail.
- SMS for mobile messaging.
- Modbus RTU-Modbus Remote Terminal Unit communication protocol for BMS over an RS-485 serial network (Modbus RTU RS-485).
- Modbus TCP-Modbus Transmission Control Protocol for BMS over Internet or LAN.
- BACnet IP-BACnet over Internet Protocol for BMS over Internet or LAN.
- BACnet MSTP-BACnet Primary-Secondary/Token-Passing communication protocol for BMS over an RS-485 serial network (Modbus MSTP RS-485).

8.1 BMS and Vertiv™ Liebert® IntelliSlot Settings

When communicating with a building management system (BMS) with an optional IntelliSlot Unity card or via embedded Unity function, the BMS settings are identical and include:



- Disconnect fail safe
- Manual fan speed control
- Allowing the BMS to change fan speed
- Backup fan control

8.1.1 Configuring BMS Communication with Embedded Unity

By default, built-in Unity function is disabled. You must enable communication with the BMS via the IS-UNITY options in Vertiv™ Liebert® iCOM™.

To configure Modbus, BACnet, SNMP, SMS and HTTP communication, see [Communication Setup with Embedded Unity](#) on page 83.

To Enable Embedded Unity Function

1. Touch  , then  > *BMS & Teamwork* > *BMS Setup*.
The BMS SETUP panel opens.

2. Select *IntelliSlot Card Settings* and one of the following in *Monitoring Protocol*:
 - *Embedded* to use built-in Unity function.
 - *Embedded & IS V4* to use built-in Unity and additional Vertiv™ Liebert® IntelliSlot card or Vertiv™ Liebert® SiteLink connection.
3. Touch *Save & Restart (Unit Only)*.

IntelliSlot Options

Monitoring Address

Address used by an optional, installed IntelliSlot card. Factory default is 3.

- Do not modify the monitoring address unless directed to do so by Vertiv technical support.



Monitoring Protocol

Protocol used for communication with BMS. Options are:

- Velocity V3: Legacy Velocity communication card
- IGM: IGMNet communication cards
- Velocity V4: Vertiv™ Liebert® IS-UNITY card or Vertiv™ Liebert® SiteLink/Vertiv™ Liebert® Sitescan™.
- Embedded: Embedded IS-UNITY function
- Embedded & IS V4: Both Embedded Unity function and Velocity V4 for an optionally installed Liebert® IS-UNITY card or Liebert® SiteLink/Liebert® Sitescan™.

8.1.2 Setting BMS Control Settings

NOTE: If a Liebert® Sitelink/Liebert® Sitescan™ Connection and MODBUS RTU or BACnet MSTP is required simultaneously, then the purchase of the RS-485 Expansion Board is required. Contact your local Vertiv sales rep or the factory.

1. Touch  , then  > *BMS & Teamwork* > *BMS Setup* > *Control Settings*. The CONTROL SETTINGS secondary panel opens.
2. Adjust the settings, and touch *Save*. The settings are configured.

NOTE: Use Configure Timeout to configure the setpoints used in the event of an outage and BMS takes control. See [Setting BMS Backup Setpoints](#) on the facing page .

NOTE: Depending on the type of thermal management unit, included components, and control settings of your system, all of the options listed may not be available on your Vertiv™ Liebert® iCOM™ display.

BMS Control Settings Options

BMS is Connected To

- Velocity
- Analog Input 1-4

BMS Fan Speed Local Override

Enables/disables local override of the fan-speed set via BMS.

Fan Control Sensor

Currently selected fan control sensor. Must be set to Manual for BMS control. See [Configuring Fan Setpoints](#) on page 30 .



Handshake

Sets a time period, in minutes, in which communication between the BMS and Vertiv™ Liebert® iCOM™ must occur.

Maximum Fan Speed

Current fan speed setting (set via fan setpoints or by BMS).

8.1.3 Setting BMS Backup Setpoints

1. Touch , then  > *BMS & Teamwork* > *BMS Setup* > *Configure Timeout* button on the lower-right of the panel. The CONFIGURE TIMEOUT secondary panel opens.
2. Adjust the values, and touch *Save*. The settings are configured.

NOTE: Depending on the type of thermal management unit, included components, and control settings of your system, all of the options listed may not be available on your Vertiv™ Liebert® iCOM™ display.

BMS Timeout Settings Options

BMS Backup Fan Operation

Enables/disables BMS operation of the fans during back up operation. Options are:

- Disabled
- BMS Backup Spd
- Coupled
- BMS Backup Set

BMS Backup Temp Setpoint

Temperature that the cooling unit maintains during BMS back up operation.

8.2 Communication Setup with Embedded Unity

The following sections describe the configuration options for embedded Unity function including Modbus, BACnet, SNMP, SMS, and HTTP communication.

NOTE: The Unity configuration is also accessible through the Unity web interface. For details on accessing and using the web interface, refer to the *Vertiv™ Liebert® IntelliSlot Unity Card Installer/User Guide*, available at www.vertiv.com.

IS-UNITY setup includes the following options to configure Unity function and communication:

- Connection
 - [Connecting to the BMS](#) below
 - [Embedded Unity User and Password](#) on page 88
 - [Troubleshooting Unity Connection and Set Up](#) on page 86
- Configuration
 - [System Configuration](#) on page 89
 - [Local Users Configuration](#) on page 90
 - [Network Configuration](#) on page 91
 - [Web Server Configuration](#) on page 93
 - [Remote Services Configuration](#) on page 96
 - [Velocity Protocol Configuration](#) on page 99
 - [Messaging Configuration](#) on page 100
- Protocols
 - [BACnet Protocol Setup](#) on page 105
 - [Modbus Protocol Setup](#) on page 108
 - [SNMP Protocol Setup](#) on page 110
 - [Unity Status Readings](#) on page 114
 - [Unity Support Information](#) on page 115

8.2.1 Connecting to the BMS

The embedded Unity software resides on the Vertiv™ Liebert® iCOM control board. There are two methods of connecting to a BMS, via Ethernet or RS-485.

For a network connection, connect the Ethernet cable from the BMS to P74 on the Liebert® iCOM™ control board. **Figure 8.1** on the facing page, shows the connector location.

For an RS-485 connection, connect the serial cable from the BMS to TB3 on the Liebert® iCOM™ control board. Pin 1 is the positive terminal on the right in **Figure 8.1** on the facing page.

If the optional RS-485 Expansion Board is purchased, TB1 on the Expansion Board is then used for BACnet MSTP or MODBUS RTU and TB3 on the Vertiv™ Liebert® iCOM™ Board is used to connect directly to a Vertiv™ Liebert® Sitelink/Vertiv™ Liebert® SITESCAN™ System.

Please see **Figure 8.2** on page 86 for TB1 Pin-outs and description.

Figure 8.1 Control Board Connections

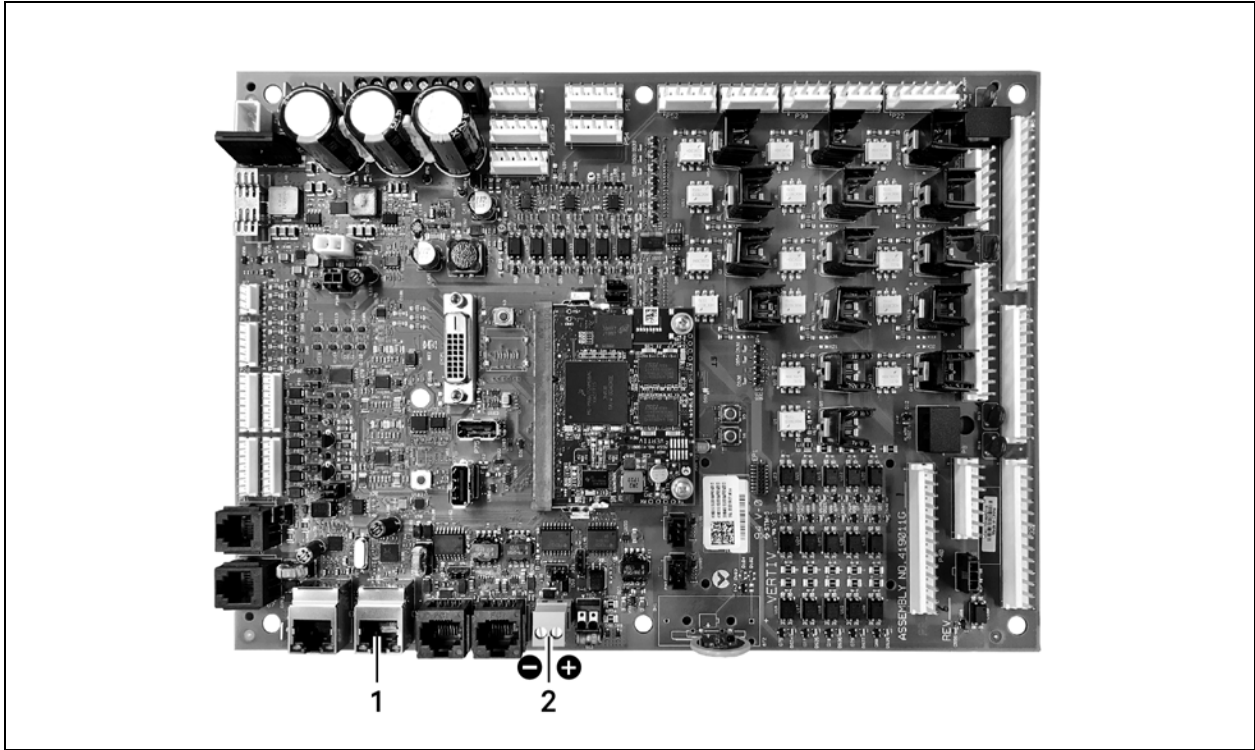

No.	Description
1	P74 Ethernet port
2	485 two wire terminal connector

Troubleshooting Unity Connection and Set Up

Figure 8.2 RS-85 Expansion Board

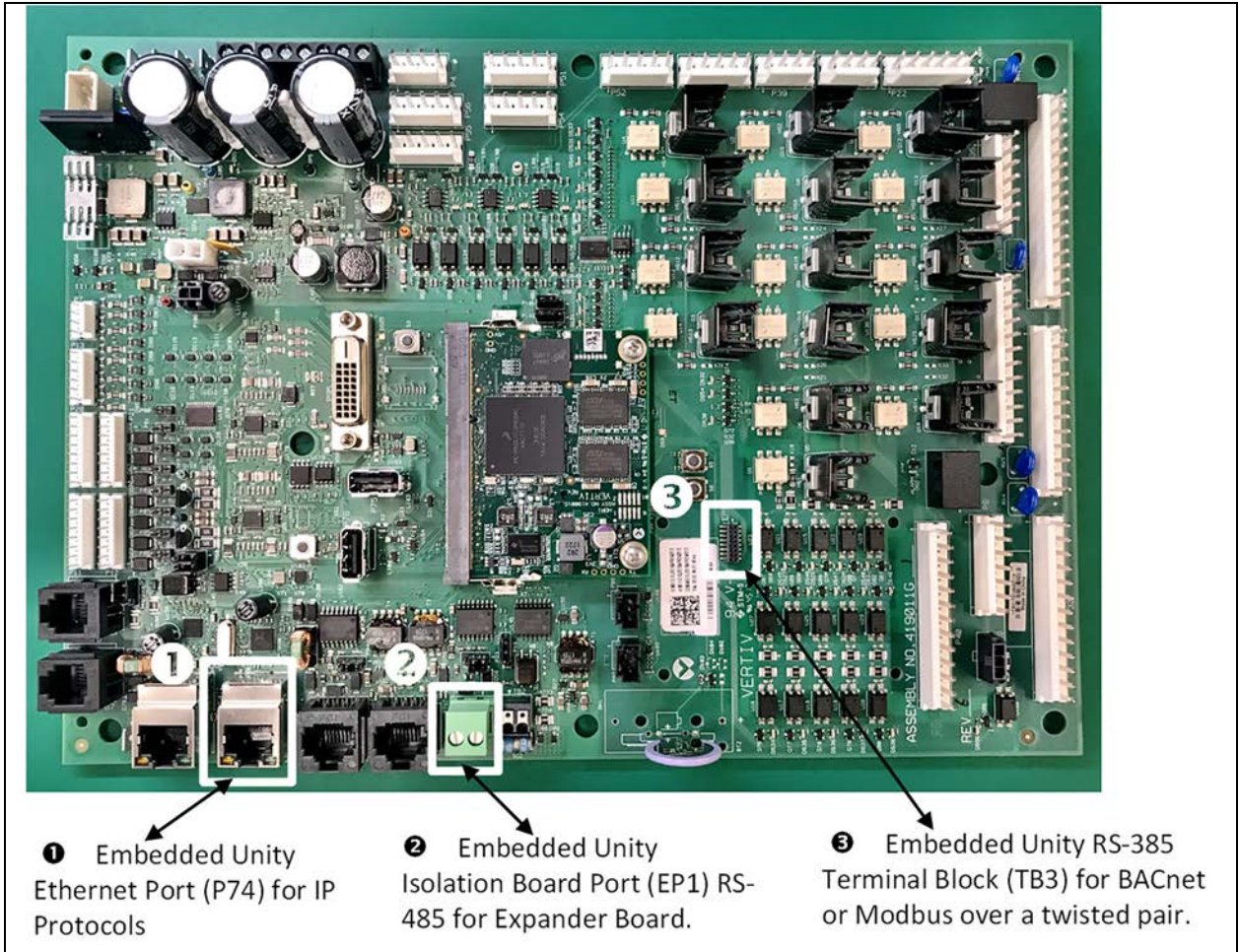

Item	Description
1	Embedded Unity Ethernet port (p74) for IP protocols
2	Embedded Unity RS-485 Terminal Block (TB3) for BACnet or Modbus over twisted pair
3	Embedded Unit isolation board port (EP1) RS-485 for expander board

The expansion board is needed only if there is a requirement to do Velocity 4 to IntelliSlot based cards and BACnet or Modbus RS-485 simultaneously. See **Figure 8.3** on the facing page for the expansion board.

Figure 8.3 Expansion Board

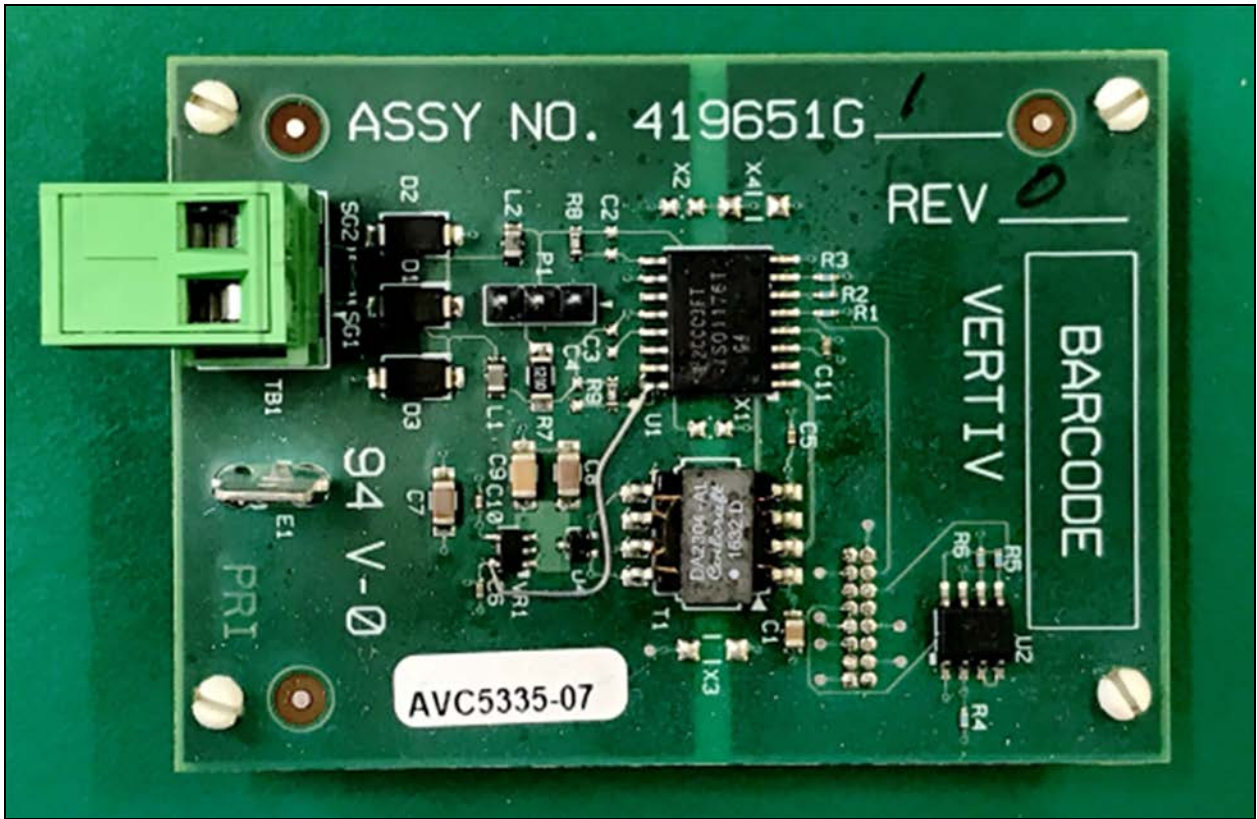

Table 8.1 below, lists problems you may encounter with the Unity software and possible solutions.

Table 8.1 Embedded Unity Troubleshooting

Problem	Possible cause	Suggested Remedy
Settings are not available in local unit Vertiv™ Liebert® iCOM™ display, show as "IS-Unity Service is Unavailable"	Embedded Unity is not enabled.	Make sure the correct monitoring protocol is selected in BMS Setup. See Configuring BMS Communication with Embedded Unity on page 81.
	Unity software needs more time to boot up since most recent Liebert® iCOM™ controller or Unity reboot.	Wait no more than 10 minutes to give enough time to boot up.
	The Liebert® iCOM™ user and password for Unity are incorrect.	Enter a valid user name and password for the Liebert® iCOM™-to-Unity connection. See Embedded Unity User and Password on the next page.
	Embedded Unity has crashed.	Restart, and wait at least 5 minutes to fully boot up. See Unity Restart and Restore Defaults on page 89.
	Unity configuration had become corrupt.	Restore to defaults, see Unity Restart and Restore Defaults on page 89. NOTE: All customized Unity configuration settings will be lost. Use this as a last resort.
Ethernet to BMS network not communicating or connecting	BMS Ethernet drop is connected to the wrong RJ-45 connector on the Liebert® iCOM™ control board.	Make sure that the cable is connected to P74 on the Liebert® iCOM™ control board, and corrected if needed.



Table 8.1 Embedded Unity Troubleshooting (continued)

Problem	Possible cause	Suggested Remedy
	Ethernet cable is bad or incorrectly made.	Use a cable tester that gives a quality rating and length (sends a true data packet) to test the cable and correct as needed.
	Incorrect network settings.	Correct the IPv4 network settings, see IPv4 and IPv6 Configuration on page 92 . NOTE: If you adjust the settings, you must restart the Unity software for the changes to take effect.
485 twisted pair to BMS network not communicating or connecting	Incorrect polarity.	Correct the polarity. See Connecting to the BMS on page 84 .
	Incorrect protocol settings.	Verify and correct the settings. Refer to the configuration settings that apply to your system: <ul style="list-style-type: none"> • BACnet Protocol Setup on page 105 . • Modbus Protocol Setup on page 108 . • SNMP Protocol Setup on page 110 .
	Protocol settings have not been saved.	Save the settings, and restart Unity so the configuration is authorized/applied. See Unity Restart and Restore Defaults on the facing page .

8.2.2 Embedded Unity User and Password

Changes to the Unity configuration are authenticated with a user/password that is stored in Vertiv™ Liebert® iCOM™. The stored user name and password must match that of a user account in embedded Unity, see [Local Users Configuration](#) on page 90 , for a description of the Unity accounts. By default, the user is Liebert and the password is Liebert (case sensitive).

If you are not using the default combination in Unity, then you must update Liebert® iCOM™ with the matching username and password.



1. Touch , then  > *BMS & Teamwork* > *IS-Unity Settings*.
2. Adjust the Username and Password, and touch *Save*.

8.2.3 Unity Restart and Restore Defaults



Some types of configuration changes require a restart of the embedded Unity software to take effect. Using the Restart IS-Unity option, does not affect the Vertiv™ Liebert® iCOM™ controller.

You also have the option of restoring the configuration to factory defaults if communication problems occur and cannot be remedied with troubleshooting

To Restart Embedded Unity

1. Touch , then  > *BMS & Teamwork > IS-Unity Settings*.
2. Touch *Restart IS-Unity*, then *Save*.



To Reset the Configuration to Factory Defaults

1. Touch , then  > *BMS & Teamwork > IS-Unity Settings*.
2. Touch *Default IS-Unity Setup*, then *Save*.



8.2.4 System Configuration

System displays general information about the monitored and managed device. You can select the temperature units displayed, which is Celsius by default.

To Update the System Settings

1. Touch , then  > *BMS & Teamwork > IS-Unity Setup > Configuration > System*.
2. Adjust the information, and touch *Save*. The settings are configured.

Time Service Settings

1. Touch , then  > *BMS & Teamwork > IS-Unity Setup > Configuration > System > Time Service*.
2. Adjust the settings, and touch *Save*.

Time Service Setting Options

External Time Source

The external source to use for time synchronization. Default is NTP Server.

Primary NTP Time Server

URL, Hostname, or IP address of the primary NTP time source. Has a 64 character maximum.

Backup NTP Time Server

URL, Hostname, or IP address of the back-up NTP time source. Has a 64 character maximum.

NTP Time Sync Rate

The rate at which time will be synchronized with the network time protocol server, if NTP is the external time source.

Time Zone

Time zone where the device is located.

Enable Auto-Sync to Managed Device

Enable automatic writing time to the managed device.

Managed Device Auto-Sync Rate

Rate at which time will be written to the managed device, if an external time source has been selected.

8.2.5 Local Users Configuration

Local Users offers up to 10 users and three access levels described in **Table 8.2** below .

The default password for all users is *Liebert* (case sensitive).



Table 8.2 User Access Levels

Level Name	Access/Permission Type	Description
No Access	None	The No Access level is enforced when Password Protected Site is enabled.
General User	Read-only	Able to view all tabs, folders and sub-folders of the user interface. A General User will only need to enter the assigned password if Password Protected Site is enabled, see Web Server Configuration on page 93 . By default, Local User [2] is <i>User</i> with the default password <i>Liebert</i> (both are case sensitive). The Authorization (access type) for Local User [2] is General User.
Administrator	Read/Write	Able to edit settings using the assigned password, which is always required to edit settings/configuration. By default, Local User [1] is <i>Liebert</i> with the default password <i>Liebert</i> (both are case sensitive). The Authorization (access type) for Local User [1] is Administrator. Be sure that you always have one administrator user, so you can access and modify configuration and other settings.



IMPORTANT! Record user names and passwords and save them in a secure place where they can be found if forgotten. A lost password cannot be retrieved from the IS-UNITY card. If the administrator password is lost, the card must be reset to factory defaults and reconfigured.

To Change the User Names and Passwords

NOTE: There is a 30 character maximum. All printable characters are valid except: \ : ' < > ~ ? " #

1. Touch  , then  > *BMS & Teamwork* > *IS-Unity Setup* > *Configuration* > *Users* > *User [n]*.
2. Enter a new user name and password.
3. Re-enter the password to confirm it.
4. In *Authorization for User*, select the type of access, see **Table 8.2** above .
5. Touch *Save*.

8.2.6 Network Configuration

1. Touch , then  > *BMS & Teamwork > IS-Unity Setup > Configuration > Network*.
2. Adjust the settings, and touch Save.

Network Setting Options

Speed Duplex

Selects the speed and duplex configuration of the card's Ethernet port. It is set to Auto by default. If it requires changing, contact the system administrator for the proper settings.

Hostname

Identifies the network node. Default is *UNITY-serial_number_of_card*.

Domain Name Suffix List

Listing of domain name suffixes for resolution of host names. If it requires changing, contact the system administrator for the proper setting.

Telnet Server



Enables/disables telnet access to the card to prevent unauthorized changes. The default setting disables telnet access.

SSHv2 Server

Enables/disables SSHv2 (Secure SHell) access to the card to prevent unauthorized changes. The default setting disables SSHv2 access.

IPv4 and IPv6 Configuration

The IPv4 and IPv6 settings determine which internet protocol will be used for communication over the network connected to the Ethernet port. IPv4 and IPv6 networks will run in parallel (dual stack network), but the protocols are different. See your network administrator to determine which protocol should be enabled and to determine the correct settings.

1. Touch , then  > *BMS & Teamwork* > *IS-Unity Setup* > *Configuration* > *Network* > *IPv4 or IPv6*.
2. Adjust the settings, and touch Save.

IPv4 Settings

IPv4 Protocol

Enables IPv4 in the card

IP Address Method

Mode the card boots into to be a network ready device (Static, DHCP, BootP). Default is DHCP.

Static IP Address

Network address for the interface.

Subnet Mask

Network mask for the interface which divides a network into manageable segments

Default Gateway

IP address of the gateway for network traffic destined for other networks or subnets.

DNS Server Address Source

Source of DNS server identification (None, Automatic, Configured).

Primary DNS Server

Network address of the primary DNS server.

Secondary DNS Server

Network address of the secondary DNS server.

IPv6 Settings

IPv6 Protocol

Enables IPv6 in the card.

IP Address Method

Mode the card boots into to be a network ready device (Static, Auto). Default is Auto.

Static IP Address

Network address for the interface.

Prefix Length

Prefix length for the address that divides a network into manageable segments.

Default Gateway

IP address of the gateway for network traffic destined for other networks or subnets. Default is 64.

DNS Server Address Source

Source of DNS server identification (None, Automatic, Configured). Default is Automatic.

Primary DNS Server

Primary DNS Server

Secondary DNS Server

Secondary DNS Server

Domain Name Server Test

The Domain Name Server (DNS) test checks key points of a DNS setup for a given domain.

1. Touch , then  > *BMS & Teamwork* > *IS-Unity Setup* > *Configuration* > *Network* > *DNS Test*.
2. Adjust the settings, and touch *Save*.

DNS Test Settings**Last Query Response**

Response from a DNS to the last query.

Example: *gxtwebdemo.liebert.com* resolved to *126.4.203.251*

Type of Query



Type of DNS query. (Hostname, IP Address)

Query Value

Value for the domain name server (DNS) to resolve. Example: *gxtwebdemo.liebert.com*

8.2.7 Web Server Configuration

Web Server Settings configures some security settings, such as HTTP or HTTPS, and password enabling.

1. Touch , then  > *BMS & Teamwork* > *IS-Unity Setup* > *Configuration* > *Web Server*.
2. Adjust the settings, and touch *Save*.

Web Server Settings

Web Server Protocol

Select the operation mode of the web server (HTTP, HTTPS).

HTTP Port

Standard web port not encrypted. Required if HTTP is enabled as web server protocol. Default is 80. Must be set to 80 for correct Vertiv™ Liebert® iCOM™ connection.

HTTPS Port

Standard secure web port; all communication is encrypted. Required if HTTPS is enabled as web server protocol. Default is 443. Must be set to 443 for correct Liebert® iCOM™ connection.

Password Protected Site

When enabled, a log in session is required before any device information is displayed to the user. User level credentials will allow only viewing of device information. Administrator level credentials are required to make any changes.

Remote Write Access

When enabled, all web browsers have write access to data on all Unity card web pages when the user is logged in with Administrator credentials. When disabled, write access is restricted to web browsers connected on an Autoconfiguration IPv4 address. An Autoconfiguration IPv4 address is of the form 169.254.x.x, and is negotiated automatically when a direct connection is made between the Ethernet port of your PC and the Ethernet port of the Unity card. Regardless of this setting, all web browsers always have read access to the web pages (subject to the setting of the Password Protected Site parameter), and the diagnostic information file can be generated when the user is logged in with Administrator credentials (see [Unity Support Information](#) on page 115).

NOTE: When remote write access is disabled, an indicator is displayed in the upper right corner of the web page as a reminder, shown in the following figure.

NOTE: Only disable remote write access if you are absolutely sure that you do not need to administer the managed device or the Unity card through a remote web browser session.

Session Idle Timeout

The interval the software will wait before logging off a user unless there is user activity. The default is five minutes.

Certificate Configuration

When the web server protocol is configured to use HTTPS communications, all web server communication with all browsers is encrypted and validated based upon the security algorithms and validity checks specified in the SSL certificate that is currently installed in the card. By default, the card generates its own unique, self-signed SSL certificate when it is first powered up. However, many installations want to install and use SSL certificate files that were generated by their own Certificate Authority (CA).

Selections in Certificate provide commands to Upload SSL Certificate PEM Files or Generate Self-Signed SSL Certificate.

Certificate Commands

Generate Self-Signed SSL Certificate

Generates and installs a new self-signed certificate based on the mode selected for Generate Self-Signed SSL Certificate Mode. See [Generating a Self-Signed SSL Certificate](#) on the next page .

Generate Self-Signed SSL Certificate Mode

Method used to generate a self-signed SSL certificate. Options are:

- Use Default Values: The values used in place of the user configurable fields are the same as those used when the original SSL certificate was generated by the card on first power up. The default values are not displayed.
- Use Configured Settings: The user entered values in the configurable fields are used to generate the certificate.

NOTE: When using configured settings, all of the configurable fields, described below, must have an entry to successfully generate a certificate.

Common Name

Fully qualified domain name that browser clients will use to reach the card's web server when it is running with the certificate generated with the name entered here.

Organization

Organization or company identified as the owner of the generated certificate.

Organizational Unit

Organizational unit or company division of the organization identified as the owner of the generated certificate.

City or Locality

City or locality of the organization identified as the owner of the generated certificate.

State or Province

State or province of the organization identified as the owner of the generated certificate.



Country Code

Country code (two letter abbreviation) of the organization identified as the owner of the generated certificate.



Email Address

E-mail address of the contact within the organization identified as owner of the generated certificate.

Generating a Self-Signed SSL Certificate

1. Touch , then  > *BMS & Teamwork* > *IS-Unity Setup* > *Configuration* > *Web Server* > *Certificate*.
2. In Generate Self-Signed SSL Certificate Mode, select the mode to use.
 - If you select *User Configured Settings*, make entries in all of the configurable-value fields (required).
3. Touch *Save*.
4. Follow the instructions in the dialog to generate and install the certificate.

8.2.8 Remote Services Configuration

1. Touch , then  > *BMS & Teamwork* > *IS-Unity Setup* > *Configuration* > *Remote Services*.
2. Adjust the settings, and touch *Save*.

The folder contains sub-folders for connectivity and diagnostics:

- [Remote Services Connectivity](#) on the facing page
- [Remote Services Diagnostics](#) on page 98

Remote Service Options and Settings**Serial Number From Device**

Serial number obtained from the managed device. Identifies the device to the system unless *Device Serial Number Override* is enabled.

Reset Remote Services Config

Resets configuration of the remote service back to factory defaults.

NOTE: Does not reset the communication card configuration.

Remote Service

Enables/disables remote service connection.

Device Data Sampling

Enables/disables, data sampling of the device.

Device Serial Number

Serial number used when *Device Serial Number Override* is enabled.

Device Serial Number Override

Enables/disables use of the serial number obtained from the managed device.

Site Equipment Tag Number

Number from the site equipment tag.

Site Identifier

Site identification number.

Device Instance ID

Manufacturer's device identification number.

Service Center Country

Country in which the device is serviced.

Remote Services Connectivity**Remote Service Connectivity Options and Settings****Connectivity Test Result**

Result of most recent connectivity test.

Test Connectivity

Initiates connectivity test.

Evaluate Remote Services Configuration

Attempt to connect to the remote service to verify the configuration.

Remote Service Platform URL

URL address of the remote-service platform. Do not enter the "http://" or "https://" prefix.

Connection Retry Time

Length of time to attempt reconnection in the event of a communication failure. Range is 30 to 600 seconds.

Proxy Enable

Enables use of remote service platform URL to connect with a proxy server.

Proxy Authentication

Enables authentication of the proxy server.

Proxy Address

IP or URL address of the proxy server.

Proxy IP Port Number

Port number of the proxy server. Range is 1 to 65535.

Proxy User Name

User name of the proxy server.

Proxy User Password

Password of the proxy server.

Remote Service Cloud URL

URL address of the remote-service cloud. Do not enter the "http://" or "https://" prefix.

Remote Services Diagnostics**Remote Service Diagnostic Settings****Communication Status**

Results of the most recent transaction.

Communication Error Count

Number of communication errors since reboot.

Last Communications Error

Most recent communication error message since reboot with date and time stamp.

Monitored Device Rule File Information

Details about the remote service rule file in effect for the monitored device.

Remote Services Operating Status

Status of the remote service.



Managed Device Status

Status of managed device's communication with the card.

8.2.9 Velocity Protocol Configuration

Velocity protocol contains four sub-folders: Managed Device, MSTP, Ethernet, and Internal.

NOTE: With the exception of changing the node ID when multiple cards are used or when disabling Velocity Protocol IP access, the settings in the Velocity Protocol sub-folders should not be modified unless directed by a Vertiv representative.

1. Touch , then  > *BMS & Teamwork* > *IS-Unity Setup* > *Configuration* > *Velocity Protocol*.
2. Adjust the settings, and touch Save.

Velocity Protocol Options

Velocity Protocol IP Access

When disabled, prevents access from a remote, IP-based system using the Velocity Protocol.

Velocity Protocol Managed Device Options

Connection State

Status of connection to managed device.

FDM Version

Version of the managed device.

Product Sequence ID

Product sequence identifier of the managed device.

LAN Type

Type of interface connection to the managed device. Must be set to MSTP Internal for correct communication with Vertiv™ Liebert® iCOM™.

Node ID (MSTP Only)

Identifier of the managed device on an MSTP LAN.

IP Address (IP Only)

Address of the managed device on an IP LAN.

Velocity Protocol MSTP Options

Interface

Type of MSTP interface.

Data Rate

Communication rate in bps.

Max Master Address

Maximum node ID in-use on the MSTP interface.

Network Number

Network number of the MSTP interface. 1 to 65534.

Node ID

Node ID of the agent card on the MSTP LAN. 0 to 127.

Velocity Protocol Ethernet Options**Velocity Protocol IP Port Number**

Port number of the IP interface, 1 to 65535.

Network Number

Network number of the Ethernet interface, 1 to 65534.

Velocity Protocol Internal Options**Network Number**

Internal network number used on the agent card. Not available to other interfaces.

8.2.10 Messaging Configuration

Messaging enables and disables email and text messaging about events. It includes a test to determine if email and text messages can be successfully sent. Settings specify message recipients, the format of the messages, and other details.



Messaging Options**Email**

May be enabled to send email messages about events

SMS

May be enabled to send text messages about events

E-mail Messaging Configuration

1. Touch , then  > *BMS & Teamwork > IS-Unity Setup > Configuration > Messaging > Email.*
2. Adjust the settings, and touch Save.

E-mail Settings

E-mail From Address

Sender's e-mail address. In most cases this will be the e-mail address of the person to whom replies should be sent. For example, *Support@company.com*

E-mail To Address

E-mail address of the recipient. Multiple e-mail addresses should be separated by a semicolon.

E-mail Subject Type

Subject of the email. This value will default to the event description. The subject line can be customized.

Custom Subject Text

The subject of the email can be changed

SMTP Server Address

Fully qualified domain name or IP address of the server used for relaying email messages. If using a server name, a DNS server may need to be configured under Network Settings.

SMTP Server Port

SMTP server port.

SMTP Connection

SMTP server connection type. Determines the capabilities of the SMTP server. Options are:

- Clear: Do not use encryption
- SSL/TLS: Encryption using SSL/TLS connection
- STARTTLS: SSL/TLS encryption initiated using STARTTLS.

SMTP Authentication

Enable or disable email SMTP authentication. An e-mail account must be provided for the SMTP service provider to authenticate.

NOTE: Some e-mail servers may require account configuration changes to allow communication with the Unity card. For example, Gmail only recognizes Google applications as being secure. However, they provide an account setting that allows authentication with what they consider "less secure apps." Please see your network administrator or service provider for configuration details.

SMTP Username

Username of the e-mail account to use when e-mail SMTP authentication is enabled.

SMTP Password

Password for the e-mail account to use when e-mail SMTP authentication is enabled.

Include IP Address in Message

If checked, the IP Address of the agent card will be included in outgoing messages.

Include Event Description in Message

If True, SNMP event description will be included in outgoing messages.

Include Name in Message

If checked, the agent card Name will be included in outgoing messages.

Include Contact in Message

If checked, the agent card contact will be included in outgoing messages.

Include Location in Message

If checked, the agent card location will be included in outgoing messages.

Include Description in Message

If checked, the agent card description will be included in outgoing messages.

Include Web Link in Message

If checked, a web link to the agent card and web server listening port number will be included in outgoing messages.

Enable Event Consolidation

If checked, multiple events will be sent per outgoing message.



Consolidation Time Limit

If Event Consolidation is enabled, a message will be sent when Consolidation Time Limit seconds has passed since the first buffered event was received.

Consolidation Event Limit

If Event Consolidation is enabled, a message will be sent when the number of buffered events reaches the Consolidation Event Limit.

SMS Messaging Configuration

1. Touch , then  > *BMS & Teamwork > IS-Unity Setup > Configuration > Messaging > SMS.*
2. Adjust the settings, and touch Save.

SMS Settings

SMS From Address

The sender's SMS address. In most cases this will be the SMS address of the person to whom replies should be sent. For example, Support@company.com.

SMS To Address

The SMS address of the recipient. Multiple SMS addresses should be separated by a semicolon.

SMS Subject Type

Subject of the message, either default or custom.

Custom Subject Text

The subject of the message. The subject can be customized by the customer.

SMTP Server Address

Fully qualified domain name or IP address of the server used for relaying SMS messages.

NOTE: If using a server name, a DNS server may need to be configured under Network Settings.

SMTP Server Port

SMTP server port.

SMTP Connection

SMTP server connection type. Determines the capabilities of the SMTP server. Options are:

- Clear: Do not use encryption.
- SSL/TLS: Encryption using SSL/TLS connection.
- STARTTLS: SSL/TLS encryption initiated using STARTTLS.

SMTP Authentication

Enable or disable SMS SMTP authentication. An SMS account must be provided for the SMTP service provider to authenticate.

NOTE: Some messaging servers may require account configuration changes to allow communication with the Unity card. For example, Gmail only recognizes Google applications as being secure. However, they provide an account setting that allows authentication with what they consider less secure apps. Please see your network administrator or service provider for configuration details.

SMTP Username

Username of the SMS account to use when SMS SMTP authentication is enabled.

SMTP Password

Password for the SMS account to use when SMS SMTP authentication is enabled.

Include IP Address in Message

If True, the IP Address of the agent card will be included in outgoing messages.

Include Event Description in Message

If checked, SNMP event description will be included in outgoing messages.

Include Name in Message

If checked, the agent card name will be included in outgoing messages.

Include Contact in Message

If checked, the agent card contact will be included in outgoing messages.

Include Location in Message

If checked, the agent card location will be included in outgoing messages.

Include Description in Message

If checked, the agent card description will be included in outgoing messages.

Include Web Link in Message

If checked, a web link to the agent card and web server listening port number will be included in outgoing messages.

Enable Event Consolidation

If checked, multiple events will be sent per outgoing message.

Consolidation Time Limit



If Event Consolidation is enabled, a message will be sent when Consolidation Time Limit seconds has passed since the first buffered event was received.

Consolidation Event Limit



If Event Consolidation is enabled, a message will be sent when the number of buffered events reaches the Consolidation Event Limit.

Messaging Test

Tests the set up for e-mail and SMS messages. If the test fails, incorrect settings should be changed to ensure that proper notifications are sent if an event should occur.

1. Touch , then  > *BMS & Teamwork* > *IS-Unity Setup* > *Configuration* > *Messaging* > *Messaging Test*.
2. Enter the settings, select the type of test in *Send Test Message*, and touch *Save*.

8.2.11 BACnet Protocol Setup

1. Touch , then  > *BMS & Teamwork* > *IS-Unity Setup* > *Protocols* > *BACnet*.
2. Adjust the settings, and touch *Save*.
3. Configure the BACnet interface chosen.
See [Configuring BACnet IP Protocol](#) on the next page, or [Configuring BACnet MSTP Protocol](#) on page 107.

BACnet Settings

Managed Device Write Access

Enable or disable the BACnet server to write to the managed device.

BACnet Interface

BACnet server interface: BACnet IP or BACnet MSTP.

Device Object Instance Number

The instance number (0-4194302) of the BACnet server's device object.

Device Object Name

The name of the BACnet server's device object.





APDU Timeout

The timeout in milliseconds between APDU retries (1-65535).

APDU Retries

The number of times to retransmit an APDU after the initial attempt (0-8).

Configuring BACnet IP Protocol

1. Touch , then  > *BMS & Teamwork > IS-Unity Setup > Protocols > BACnet > BACnet IP.*
2. Set the BACnet MSTP Node ID.
 - The Node ID defaults to 1, but must have a value from 0 to 127 that is unique among devices connected through the RS-485 interface.
3. Set the BACnet MSTP data rate.
4. Set the BACnet MSTP max master address.
5. Set the BACnet MSTP max info frames.
6. Touch *Save.*
7. Restart Unity:
 - a. Touch , then  > *BMS & Teamwork > IS-Unity Settings.*
 - b. Touch *Restart IS-Unity.*, then touch *Yes.*

BACnet IP Settings

BACnet IP Port Number

The port for the BACnet server's UDP/IP connection.

Register as Foreign Device

Enable or Disable registration as a foreign device.





IP Address of BBMD

IP Address of the BACnet Broadcast Management Device (BBMD) to be accessed for Foreign Device Registration

Foreign Device Time to Live

Time to remain in the BBMD Foreign Device table after registration.

Configuring BACnet MSTP Protocol

1. Touch , then  > *BMS & Teamwork* > *IS-Unity Setup* > *Protocols* > *BACnet* > BACnet IP.
2. Set the BACnet MSTP Node ID.
 - The Node ID defaults to 1, but must have a value from 0 to 127 that is unique among devices connected through the RS-485 interface.
3. Set the BACnet MSTP data rate.
4. Set the BACnet MSTP max master address.
5. Set the BACnet MSTP max info frames.
6. Touch *Save*.
7. Restart Unity:
 - a. Touch , then  > *BMS & Teamwork* > *IS-Unity Settings*.
 - b. Touch *Restart IS-Unity.*, then touch *Yes*.

BACnet MSTP Settings

Node ID

The BACnet server's MS/TP node ID (MAC).

Data Rate

The BACnet MSTP communication rate (bits per second).



Max Master Address

The maximum node ID (MAC) in use on the MS/TP network.

Max Info Frames

Maximum number of information frames this node may send before it must pass the token.

8.2.12 Modbus Protocol Setup

1. Touch , then  > *BMS & Teamwork* > *IS-Unity Setup* > *Protocols* > *BACnet*.
2. Adjust the settings, and touch Save.
3. Configure the BACnet interface chosen. See [Configuring Modbus TCP Protocol](#) below , or [Configuring Modbus RTU Protocol](#) on the facing page .

Modbus Settings

Managed Device Write Access

Enable or disable the Modbus server to write to the managed device

Modbus Interface





Select the Modbus interface, either Modbus TCP or Modbus RTU

Configuring Modbus TCP Protocol

The Modbus TCP permits connection to the card by:

- Any client (open) permits communication by any IP address.
- Clients on the same subnet as the Unity card.
- Clients with specific IP addresses (Trusted IP Lists); only five addresses are permitted.

To configure Modbus TCP

1. Touch , then  > *BMS & Teamwork* > *IS-Unity Setup* > *Protocols* > *Modbus TCP*.
2. Adjust the settings, and touch Save.
3. Restart Unity:
 - a. Touch , then  > *BMS & Teamwork* > *IS-Unity Settings*.
 - b. Touch *Restart IS-Unity*., then touch Yes.

Modbus TCP Settings

Limit Network Access Type

IP Access List

- Open
- Same Subnet
- Trusted IP List



Port

The TCP port used by the Modbus server to listen for and respond to Modbus protocol requests based on Limit Network Access Type setting.



Maximum Client Connection Count

Displays the maximum client connection count.

Configuring Modbus RTU Protocol

1. Touch , then  > *BMS & Teamwork* > *IS-Unity Setup* > *Protocols* > *Modbus RTU*.
2. Enter the Node ID and the Baud Rate.
 - The Node ID defaults to 1, but must have a value from 1 to 247 that is unique among devices connected through the RS-485 interface.
 - The default baud rate is 9600. 19200 and 38400 are also available.

NOTE: Contact your system administrator if you are uncertain about the settings.

3. Touch Save.
4. Restart Unity:
 - a. Touch , then  > *BMS & Teamwork* > *IS-Unity Settings*.
 - b. Touch *Restart IS-Unity*., then touch Yes.

Modbus RTU Settings**Node ID**

Modbus Server ID for the interface; obtain from network administrator.

Baud Rate

Communication rate.

- 9600
- 19200
- 38400





Parity Check

The communication parity check.

- None
- Even
- Odd

8.2.13 SNMP Protocol Setup

SNMPv1/v2c and SNMPv3 are enabled by default. The protocols may be configured or their default values may be accepted. Authentication traps are not enabled by default. The default heartbeat trap interval is 24 hours. This can be disabled or the interval may be changed.

1. Touch , then  > *BMS & Teamwork* > *IS-Unity Setup* > *Protocols* > *SNMP*.
2. To enable Authentication Traps, touch to select *Enabled*.
3. To change the Heartbeat Trap Interval, choose a time from the drop-down list or choose *Disabled* to prevent any heartbeat traps from being sent.
 - The interval times offered are 5 or 30 minutes, or 1, 4, 8, 12 or 24 hours.
4. For each trap, choose whether or not to disable or set the interval to one of the periods on the menu.
5. Touch *Save*.
6. Restart Unity:
 - a. Touch , then  > *BMS & Teamwork* > *IS-Unity Settings*.
 - b. Touch *Restart IS-Unity*., then touch *Yes*.

SNMP Settings

SNMPv3 Engine ID

Read-only. The generated SNMPv3 engine ID.

NOTE: A newly-generated ID appears only after rebooting the card.

SNMP v1/v2c Enable

Enable or disable SNMP v1/v2c.

SNMP v3 Enable

Enable or disable SNMPv3.

Authentication Traps

When enabled, an authentication trap is sent if an SNMP host tries to access the card via SNMP, but either the host address is not in the SNMP access settings or it is using the wrong community string.

Heartbeat Trap Interval

Enable or disable and set interval 5 or 30 minutes, or 1, 4, 8, 12, or 24 hours.

RFC-1628 MIB

Enable or disable support for retrieval of data from the RFC-1628 MIB objects.

RFC-1628 MIB Traps

Enable or disable support for sending RFC-1628 traps.

Vertiv™ Liebert® Global Products (LGP) MIB

Enable or disable support for getting and setting data using the Liebert® Global Products MIB.

LGP MIB Traps

Enable or disable support for Liebert® Global Products MIB traps.

NOTE: LGP traps will not be sent unless LGP MIB is enabled.

LGP MIB System Notify Trap

Enable or disable support for the LGP System Notification trap. This is a single trap sent each time an alarm or warning is added or removed from the conditions table. It provides a text description of the event in a varbind of the trap message.

NOTE: LGP System Notify traps will not be generated unless the LGP MIB is enabled.

SNMPv3 Engine ID Format Type

Selects method to build the engine ID. Valid values:

- MAC Address (default): Engine ID built from the Unity card's MAC address.
- Text: Engine ID built from text entered in SNMPv3 Engine ID Text. See **Figure 8.4** on the next page .



SNMPv3 Engine ID Text

Text on which the engine ID is built when SNMPv3 Engine ID Format Type is *Text*.

NOTE: If this field is left blank, the engine ID is built from the Unity card's MAC address.

Select SNMPv3 Engine ID Format

By default, the Engine ID is automatically generated using the MAC address. Optionally, you can select a text based ID instead.

1. Touch , then  > *BMS & Teamwork > IS-Unity Setup > Protocols > SNMP*.
2. Select the format. Refer to [SNMP Protocol Setup](#) on the previous page , for descriptions of the settings and options.
 - In SNMPv3 Engine ID Format Type, select *MAC Address* or *Text*.
 - If you selected *Text*, type the text on which the generated engine ID will be based.
 - Click *Save* to confirm the changes or *Cancel* to discard them.
The new engine ID is not displayed until after rebooting the card in Step 3.
The text generated engine ID is a hexadecimal representation of ASCII characters similar to that shown in **Figure 8.4** on the next page .

NOTE: If the format type or text for the Engine ID are incomplete or invalid, the Engine ID is generated based on the MAC Address.



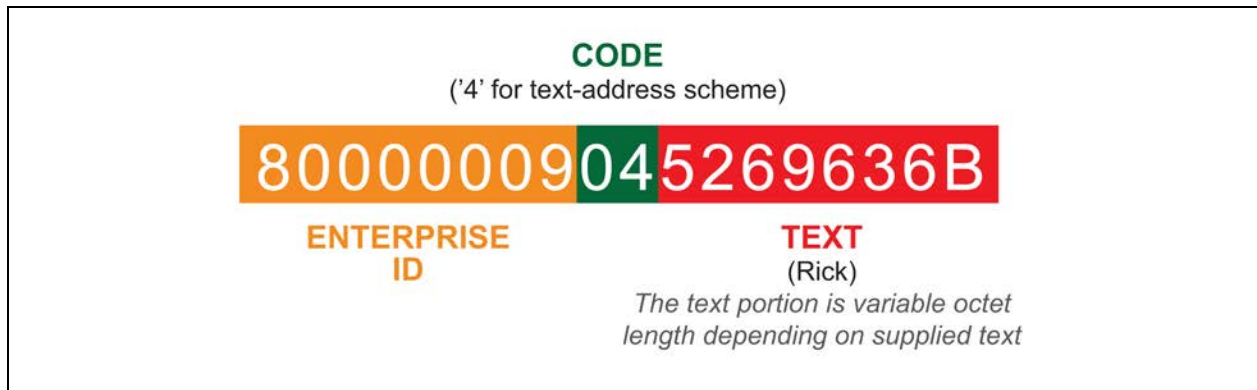

3. Restart Unity:
 - a. Touch , then  > *BMS & Teamwork > IS-Unity Settings*.
 - b. Touch *Restart IS-Unity*., then touch *Yes*.

Figure 8.4 SNMP Engine ID Generated Using Text Format Scheme



Configuring SNMPv3 Users

IS-Unity supports up to 20 SNMPv3 users. The top level is a list of all 20.

1. Touch , then  > *BMS & Teamwork > IS-Unity Setup > Protocols > SNMP > SNMPv3 Users*, then one of the listed users.
2. Enter the information and set the permissions appropriate to the user, and touch *Save*.
3. Repeat steps 1 and 2 for additional users.
4. Restart Unity:
 - a. Touch , then  > *BMS & Teamwork > IS-Unity Settings*.
 - b. Touch *Restart IS-Unity*., then touch *Yes*.

SNMPv3 User Settings

SNMPv3 User Enable

Select to enable read, write or sending notifications with the user's credentials.

SNMPv3 Username

The User name the authentication and privacy settings apply to. This string can be composed of printable characters except colon, tab, double quote, and question mark.

SNMPv3 Access Type

Read-only, Read/Write, or Traps only

SNMPv3 Authentication

Cryptographic algorithm used for authentication: None, MD5 or SHA-1

SNMPv3 Authentication Secret

Pass phrase or password used for SNMPv3 Get request. This string can be composed of printable characters with the exception of colon, tab, double quote, and question mark. The entry must be from eight to 64 characters.

SNMPv3 Privacy

Cryptographic algorithm used for encryption. Options are:

- None
- DES
- AES

SNMPv3 Privacy Secret

Pass phrase or password used for SNMPv3 Get request. This string can be composed of printable characters with the exception of colon, tab, double quote, and question mark. The entry must be from eight to 64 characters.

SNMPv3 Trap Target Addresses





Network hosts that will receive SNMPv3 traps, identified with either a network name or IP address. Multiple addresses must be separated by commas.

SNMPv3 Trap Port

Port used by the target host for receiving SNMPv3 traps; default is 162.

Configuring SNMPv1 Traps

You may configure up to 20 network hosts that receive SNMPv1 traps. The top level is a list of all 20.

1. Touch  , then  > *BMS & Teamwork > IS-Unity Setup > Protocols > SNMP > SNMPv1 Traps*, then one of the listed traps.
2. Enter the information and set the permissions appropriate to the host/trap, and touch *Save*.
3. Repeat steps 1 and 2 for additional traps.
4. Restart Unity:
 - a. Touch  , then  > *BMS & Teamwork > IS-Unity Settings*.
 - b. Touch *Restart IS-Unity*., then touch *Yes*.

SNMPv1 Trap Settings

SNMP Trap Target Addresses

Configure network hosts that will receive alert notifications (SNMP Traps). The host can be identified as either an IP address or the host's network name.

SNMP Trap Port





Port used by the target host for receiving notifications; default is 162.

SNMP Trap Community String

String identifying a secret known only by those hosts that want to be notified of device status changes.

Configuring SNMPv1/v2c Access

Unity supports up to 20 network hosts that access data using SNMPv1/v2c. The top level is a list of all 20.

1. Touch , then  > *BMS & Teamwork* > *IS-Unity Setup* > *Protocols* > *SNMP* > *SNMPv1v2c Access*, then one of the listed access options.
2. Enter the information and set the permissions appropriate to the network host, and touch *Save*.
3. Repeat steps 1 and 2 for additional users.
4. Restart Unity:
 - a. Touch , then  > *BMS & Teamwork* > *IS-Unity Settings*.
 - b. Touch *Restart IS-Unity*., then touch *Yes*.

SNMPv1/v2c Access Settings

SNMP Access IP Address

Configure network hosts interested in device information access. The host can be identified as either an IP address or the host's network name.

SNMP Access Type

SNMPv1/v2C access type: Read-only or Read/Write.

SNMP Access Community String

SNMP Community String.



8.3 Unity Status Readings

The read-only Status page displays the system status of IS-Unity and a list of events that affect its status.

To view the statuses, touch , then  > *BMS & Teamwork* > *IS-Unity Setup* > *Status*.

8.4 Unity Support Information

Support displays information about IS-Unity for troubleshooting.

1. Touch , then  > *BMS & Teamwork* > *IS-Unity Setup* > *Support*.
2. Adjust the settings, and touch *Save*.

Support Folder Settings

Agent Date and Time

Date and time setting for the card.

Agent Model

The card's model (Unity Platform).

Agent App Firmware Version

The card's firmware version (2.0 or higher).

Agent App Firmware Label.

The card's firmware label.

Agent Boot Firmware Version

The card's Boot firmware version.

Agent Boot Firmware Label

The card's boot firmware label.

Agent Serial Number

The card's serial number.

Agent Manufacture Date

The card's manufacture date.

Agent Hardware Version

The card's hardware version.

GDD Version

The card's GDD version, current when the card's firmware was installed; the GDD is a proprietary reference document for device data.

FDM Version

The card's FDM version; the FDM is a data model document that defines data supported by devices that use the Velocity Protocol.

Product Sequence ID



The card's product sequence identifier.

Device Assigned Label

Displays the label assigned to the device.

8.4.1 Configuring Active Networking Settings

Status of the currently active IP network settings for IS-Unity along with some previous values for troubleshooting IP communication issues.

1. Touch , then  > *BMS & Teamwork* > *IS-Unity Setup* > *Support* > *Active Networking*.
2. Adjust the settings, and touch *Save*.

Active Networking Settings

Ethernet MAC Address

Ethernet MAC Address for the

IPv4 Address

Presently used IPv4 network address.

IPv4 Default Gateway

Presently used IPv4 network address of the gateway for network traffic destined for other networks or subnets.

Primary DNS

Presently used IPv4 Primary DNS.

Secondary DNS

Presently used IPv4 Secondary DNS.

Last DHCP/BOOTP Address

Last known IPv4 address assigned by DHCP.

Last DHCP Lease

Lease time of last known DHCP address.

IPv6 Global Address

Shows if DHCPv6 or Static address is presently being used.

StateLess Address AutoConfiguration

IPv6 SLAAC is assigned automatically from Router Advertisement, if "A" flag is set, combining Prefix with EUI-64 MAC.

Link Local

Presently used IPv6 Link Local Address.

IPv6 Default Gateway

Presently used IPv6 network address of the gateway for network traffic destined for other networks or subnets.

Primary DNS Server

IPv6 Primary DNS.

Secondary DNS Server

Presently used IPv6 Secondary DNS.

Last DHCPv6

Last known IPv6 address assigned by DHCPv6.

Last DHCPv6 Lease

Lease time of last known DHCPv6 address.

This page intentionally left blank

9 Configuring Auxiliary Devices

NOTE: Your Vertiv™ Liebert® DSE Packaged Solution does not offer humidification or dehumidification functions. Please disregard those settings/fields when mentioned in this guide or displayed on the Vertiv™ Liebert® iCOM™ controller.



With Liebert® iCOM™, you can manage and control many devices that work with your thermal-management unit(s).

9.1 Power Monitoring

Up to six power meters may be connected to each cooling unit. Power meters are factory programmed to monitor individual components or whole cooling units. For efficient data center control, power meters provide monitoring of:

- Connection status
- Input under voltage
- Input RMS voltage leg-to-leg and leg-to-ground
- Input current per phase
- Energy consumption in kilowatt hours
- Instantaneous power in watts
- Power consumption

9.1.1 To Set Up Power Monitoring

1. Touch , then  > *Auxiliary Device Setup* > *Modbus Devices* > *Power Meters* > *Device X* (where X is the device number). The DEVICE X panel opens.
2. Adjust the power meter settings and touch Save. The power monitoring settings are saved.

NOTE: Depending on the type of thermal management unit, included components, and control settings of your system, all of the options listed may not be available on your Vertiv™ Liebert® iCOM™ display.

Power Monitoring Device Options

Address

Modbus address for the power meter.

Connection Status

Read only. The connection status of the Modbus. Valid values:

- 0: Off
- 1: Connected
- 2: Unknown
- 3: Comm Error
- 4: Disconnect
- 5: Cfg Error

Device Enable

Enables/disables the Modbus power meter.

Device X

Editable field to describe the device.

SysType

Read-only. The type of feedback from the power meter. Valid values:



- 0: 3Ph+N
- 1: 1Ph+N
- 2: 2Ph+N
- 3: 3Ph

Type

Read-only. The type of power meter.

9.2 Fluid Temperature Monitoring

Up to two supply and two return sensors may be connected to each cooling unit to monitor local and remote fluid temperature differential. A 2T sensor monitors fluid temperature (two 2T sensors on dual circuit units).

1. Touch , then  > *Auxiliary Device Setup* > *Sensors* > *Fluid Sensors* > *Fluid 2T Sensor*. The SENSOR PROPERTIES panel opens.
2. Adjust the temperature offset, and touch Save. The fluid temperature sensor settings are saved.

NOTE: Depending on the type of thermal management unit, included components, and control settings of your system, all of the options listed may not be available on your Vertiv™ Liebert® iCOM™ display.

9.2.1 Fluid Sensor Options

Current Fluid Temperature

Actual temperature reading.

Fluid Sensor Type

Type of sensor connected. Options are:

- 2T
- Dual 2T

Fluid Temperature Offset

Correction (calibration) value added to the fluid temperature reading. Used in the event that the fluid temperature sensor readings are incorrect.

- May be a positive or negative value.

9.3 Configuring Analog Input Devices

1. Touch , then  > *Auxiliary Device Setup* > *Analog Input*.
The ANALOG INPUTS and ANALOG INPUT PROPERTIES panels open.

NOTE: Depending on the type of thermal management unit, included components, and control settings of your system, all of the options listed may not be available on your Vertiv™ Liebert® iCOM™ display.

2. Before you touch a specific analog input, the properties panel lists the inputs along with their configuration status:
 - *Factory Std* indicates that the input is configured for a factory installed component such as a pressure transducer.
 - *Not Config* indicates that the input is configurable.
3. Locate the DIP switches on the control board and program the input type according to **Table 9.1** below. **Figure 9.1** below shows the switch and on/off setting.



Table 9.1 DIP Switch Settings for Analog Input Connection

Analog Input Number		Input #1		Input #2		Input #3		Input #4		Not Used	
Control Board Switch Number		1	2	3	4	5	6	7	8	9	10
Analog Input device value	0 – 10 VDC	Off	Off	Off	Off	Off	Off	Off	Off	—	—
	0 – 5 VDC	On	Off	On	Off	On	Off	On	Off	—	—
	4 – 20 mA	On	On	On	On	On	On	On	On	—	—

NOTE: Up is on, down is off on the DIP switch. Switches 9 and 10 are not used.

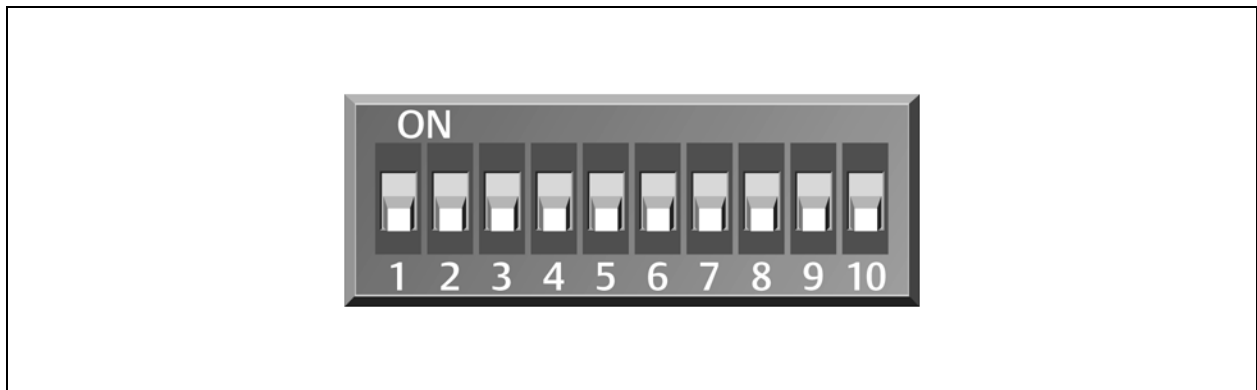
Figure 9.1 Analog Connection DIP Switches on the Control Board



4. On Liebert® iCOM™, touch , then  > *Auxiliary Device Setup* > *Analog Input* > *Customer Analog Inputs*, then touch an Analog Input. The ANALOG INPUT PROPERTIES for that device displays.
5. Select the configuration and touch Save. The analog input is configured.



NOTE: The Airflow, Static Pressure and Fluid Flow analog-input settings configure factory options and require special instruction. Contact Vertiv Technical Support at 1-800-543-2778.

9.4 Wired Remote Sensors

Wired, remote, rack sensors can function as control sensors and, subsequently, provide input individually, at the unit level, or at the system level for temperature control and teamwork functions.

Each wired-remote rack sensor has two thermistors/probes. In Individual Sensor mode, the higher temperature reading or the average temperature reading of the two probes can be used. In Unit Sensors mode, some or all of the rack sensor's temperature readings are considered for higher (maximum) or average calculation. For example, setting three sensors as control and average for unit mode, averages the three highest temperature readings.

At the system level, using a unit to unit (U2U) network, the same maximum or average calculations can be based on readings from all of the sensors in all of the units in group (including those in standby) using teamwork. See [Teamwork Modes](#) on page 65.

1. Touch , then  > *Auxiliary Device Setup* > *Sensors* > *Wired Remote Sensors* > *Setup*. The set-up SENSOR PROPERTIES panel opens.
2. Adjust the settings for the cooling units sensor array, and touch *Save*.
[Wired Remote Sensor—Set Up Options](#) below, describes the setting options.
3. Touch a specific sensor. The SENSOR PROPERTIES for that sensor open.

NOTE: The sensor number listed corresponds to the DIP switch assignment of the sensor made during installation.

4. Touch *Name*, and use the keyboard to give the sensor a descriptive name.

NOTE: This is the name displayed on the REMOTE SENSORS panel for non-service users.

5. Refer to the [Wired Remote Sensor—Sensor Property Options](#) on the facing page to adjust the remaining settings, and touch *Save*.
The wired-remote sensors for the cooling unit are configured.

9.4.1 Wired Remote Sensor—Set Up Options

Average Rack Temp

Calculated average of temperature readings from the control sensors.

Individual Remote Sensors Mode

When controlling at the sensor level, selects the method of using the readings from the two temperature thermistors (probes) on the sensor. Options are:

- Maximum: Use the highest temperature reading of the two thermistors.
- Average: Use the average of the readings from the two thermistors.

Max Rack Temp

Highest temperature reading from the unit remote sensors.

REM Sensors set to Control

Number of sensors set to control.

Unit Remote Sensors Mode

When controlling at the unit level, selects the method of using the inlet-rack temperature readings from the control sensors to control fan speed. Options are:

- Maximum: Use the highest temperature reading of the sensors set to Control.
- Average: Use the average of the readings from the sensors set to Control and included in AVG.

Unit Remote Sensors included in AVG

When Unit Remote Sensors Mode is *Average*, selects the number of sensors used to calculate the average temperature.

- If the number selected is smaller than the number of REM Sensors set to Control, only the highest readings are used for the calculation.

NOTE: Depending on the type of thermal management unit, included components, and control settings of your system, all of the options listed may not be available on your Vertiv™ Liebert® iCOM™ display.

9.4.2 Wired Remote Sensor—Sensor Property Options

Function

Sets the function of the sensor when Unit Remote Sensors Mode is enabled.

- Disable: Sensor readings are ignored.
- Reference: Sensor readings are considered for Max Rack Temp, but are not used in maximum/average calculations.
- Control: Sensor readings are used in maximum/average calculations.

Left Lead Current Value

Current reading of the left sensor probe. The left probe is always a temperature reading.

Left Lead Offset

Correction (calibration) value added to the reading. Used in the event that the sensor reading is incorrect.

- May be a positive or negative value.

Name

Custom, descriptive name to assist in identifying the sensor's location/function in the facility, for example, the name of the rack on which it is installed. The name is limited to:

- Up to four alphanumeric characters in length
- Upper or lower case characters
- The following special characters: & * / . + - : @ \.

Right Lead Current Value

Current reading of the right sensor probe. May be a temperature or humidity reading, depending on the connected sensor.

Right Lead Offset

Correction (calibration) value added to the reading. Used in the event that the sensor reading is incorrect.

- May be a positive or negative value.

9.5 Supply Sensors

When the supply air sensor is set as the control sensor for temperature, additional supply air configuration parameters (valve pulse, cooling filters and return compensation) can be used to enhance the supply air control.

The valve pulse and cooling filter timer can be adjusted to prevent oscillation around the supply setpoint and still allow for rapid cooling-capacity adjustments to compensate for heat load changes. Contact Vertiv™ technical support for adjustments.

NOTE: Supply control air temperature sensors are required to use Optimized Aisle Teamwork (mode 3).

NOTE: On units equipped with a 3P actuator type valve, response can be improved by using the feedback signal.

10 Administering Firmware, Settings and Security

10.1 Vertiv™ Liebert® iCOM™ Firmware Upgrades

NOTE: The Liebert® iCOM™ Service Tool (iST) is required to update control board firmware. Contact technical support at 1-800-543-2778 for information on control board updates.

10.1.1 Compatibility with Earlier Versions of Vertiv™ Liebert® iCOM™

Versions of Liebert® iCOM™ control firmware PA2.05.31R are incompatible with earlier firmware versions PA1.XX.XXXSTD.

The firmware versions PA2.05.31R and later cannot communicate with earlier versions. The Vertiv™ Liebert® DSE and Vertiv™ Liebert® PDX/PCW will not operate with PA1.XX.XXXSTD installed.

Contact your Vertiv representative to upgrade firmware.

10.1.2 Updating Vertiv™ Liebert® iCOM™ Control Board Firmware

The FIRMWARE UPGRADE panel shows the firmware version of the control board of the cooling unit. It also includes settings to use while performing the upgrade.

NOTE: Only personnel who have completed Vertiv training should perform a control board update. The Liebert® iCOM™ Service Tool (iST) is required to update control board firmware. Contact technical support at 1-800-543-2778 for information on control board updates.



1. Save the Liebert® iCOM™ software to a USB flash drive formatted with a FAT32 file system.
 - Make sure that the file-name extension is all lower case. For example, *.xpb* not *.XBP*.
 - Remove all other files with the *.xpb* extension from the flash drive.
2. At the Liebert® iCOM™ control:
 - Touch , then  > *Backup & Security* > . The FIRMWARE UPGRADE panel opens.
 - Make sure the *Lock for Upgrade*, is selected.
 - Refer to [Control Board Firmware Upgrade Options](#) on the next page , for the reset and retain options.
3. On the Liebert® iCOM™ control board:
 - Insert the flash drive into the P76 USB port. After a few seconds, the DS25 LED lights up green.
 - P75 does not work for firmware upgrade.
 - To continue with the upgrade, press the S3 button near the LED within 15 seconds. The LED blinks blue to indicate that the upgrade has commenced. When the upgrade completes, the LED blinks fast green, and the board reboots with the new firmware.
4. Remove the USB flash drive after the board reboots.

Figure 10.1 P76, S3 and DS25 LED on the Board



Item	Description
1	P76 port
2	DS25 LED
3	S3 button

Control Board Firmware Upgrade Options

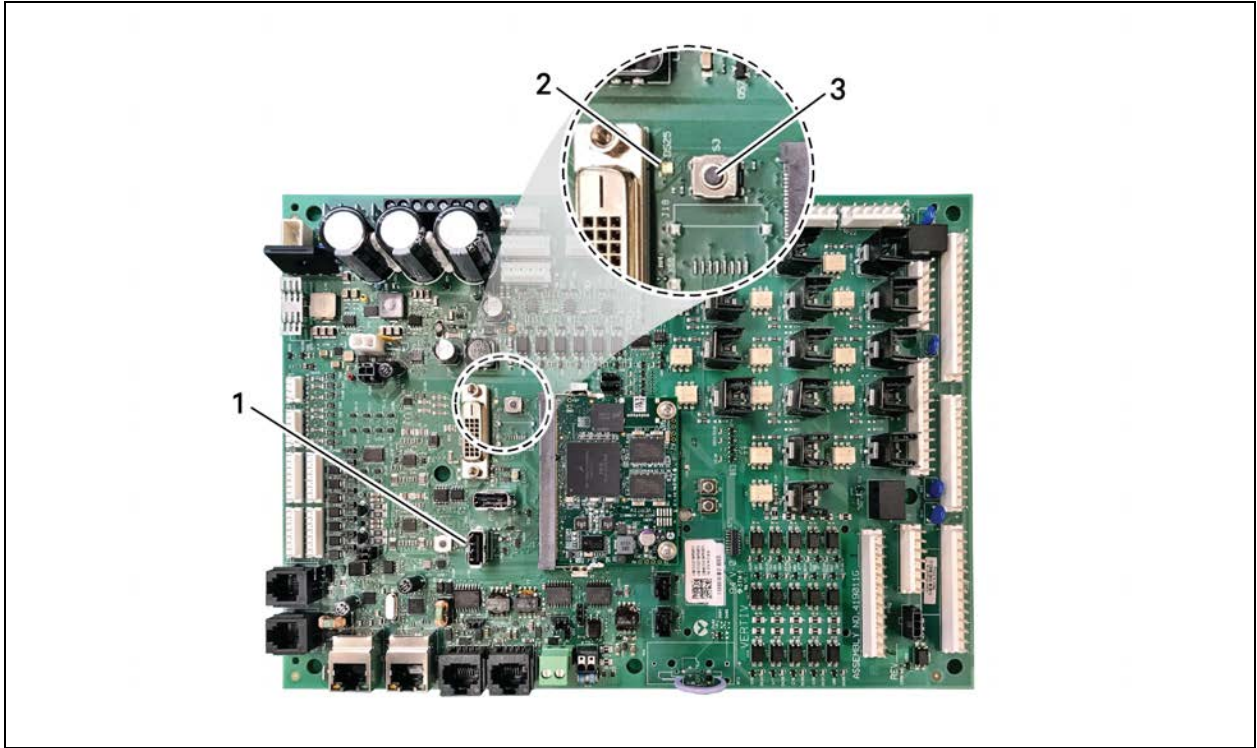
Lock for Upgrade

When selected, the unit is locked for a firmware upgrade.

Reset to Default Configuration

When selected, the unit is reset to the factory-default configuration during the upgrade

Retain Network Configuration

When selected, the current network settings and options are retained while all other settings are reset to the factory default configuration.

10.1.3 Reverting to Firmware in Dormant Partition

The Vertiv™ Liebert® iCOM control board holds firmware in two partitions:

- The active partition holds the currently running firmware.

- The dormant partition holds the previously installed firmware.

Upon firmware upgrade, the new firmware writes to the dormant partition, which switches to the active partition when the upgrade is complete. If needed, you can revert to the previously installed version that is now in the dormant partition while the board boots after the upgrade.



To return to pre-upgrade firmware:

1. At boot, watch for the DS25 LED to flash red then blue for a second or two, and after it flashes red then blue, press-and-hold S3 for six to 10 seconds until DS25 lights solid red then release. **Figure 10.1** on the previous page, shows DS25 and S3 on the board.
2. Upon releasing S3, DS25 blinks for three seconds, and you must press and release S3 during that 3 seconds. If completed correctly, DS25 lights solid green and the board is reverted to the pre-upgrade firmware in the dormant partition. If incorrect, DS25 is not lit and the board boots normally.

NOTE: Use these steps to switch between active/dormant partitions (current/previous firmware) as needed. The switch can only be initiated right after a boot of the system, so power-off the unit, wait five seconds, and power on the unit, then start at step 1 above, as the system boots.

10.2 Backing Up and Restoring Control Board Settings

Vertiv™ Liebert® iCOM settings may be saved to a local disk or USB drive, and the saved files may be imported to restore iCOM if it is replaced or if a problem occurs and to transfer settings to another iCOM.

1. Touch , then  > *Backup & Security* > *Control Backup/Restore*. The BACKUP & RESTORE panel opens.
2. Touch the *Action Type* drop-down, and select the action to perform.
3. Select the location, site, and system to save back-up files or load restore/replicate files, see [Control Board Back Up and Restore Options](#) below, for descriptions.

NOTE: USB drives are automatically detected and displayed as options for Location selection.

4. Touch the action button in the lower-right corner. A notification indicates that the back up/restore/replicate is complete.
5. Remove the USB drive from the port.

10.2.1 Control Board Back Up and Restore Options

Action Type

Selects the back up or restore function. Options are:

- **Back up:** Saves a copy of the settings in a file named with the IP address of the Liebert® iCOM™ control board. Use a backup file to restore the unit settings in the event of a failure.
- **Replicate:** Loads only the configsafe files (general settings/setpoints) from a back-up file from another system.
- **Restore:** Loads a backup configuration from a previously saved backup file. For example, when a control board fails and must be replaced, you can load the configuration from a backup of the failed board.

Location

Indicates the port to which the USB drive is connected.

Site

Indicates the folder you created on the USB drive to which the back up system file is saved.

System

The back up file named with the IP address of the control board from which it was saved.

10.3 Managing Access Permission and Passwords

NOTICE

Risk of loss of access to Vertiv™ Liebert® iCOM™ can cause operational problems.



When a password is changed, make sure you record the new password and inform authorized users. If problems arise, passwords can be reset by Vertiv Technical Support, visit <https://www.vertiv.com/en-us/support/>.

Two four digit passwords provide two levels of permission to access Liebert® iCOM™ menus and are set with factory default values. You can change the value of each password so that only those provided with the current password may access the menus that it unlocks.

The factory default password for user and service login are:

- Default User password: 1490
- Default Service password: 5010

NOTE: To change the password, you must use the Service password currently assigned to unlock the Service menu.

1. Touch , then  > *Backup & Security* > *Manage Permissions*.
The MANAGE PINS panel opens.
2. Touch the role to change, then touch the *Value* field for the password to change. The keypad opens.
3. Type a new four digit/character password, then touch , and touch *Save*. The password is saved.
 - Touch *Cancel* to discard the change.

11 Performing Diagnostics

NOTE: Depending on the type of thermal management unit, included components, and control settings of your system, all of the options listed may not be available on your Vertiv™ Liebert® iCOM™ display.

NOTE: Your Vertiv™ Liebert® DSE Packaged Solution does not offer humidification or dehumidification functions. Please disregard those settings/fields when mentioned in this guide or displayed on the Liebert® iCOM™ controller.

11.1 Cooling Unit Status LED

Just below the Vertiv™ Liebert® iCOM™ touchscreen display is an LED that changes color and flashes on-off indicating cooling unit status. See **Table 11.1** below, for the LED colors and meanings.

Table 11.1 Cooling Unit LED Colors and State Meanings

State	Color(s)	Meaning
Solid	Green	Powered on and operating.
Solid	Amber	In diagnostic/service mode or powered off.
Solid	Red	Active warning or alarm present and acknowledged.
Flashing	Amber/Green	In sleep or U2U standby mode and available to operate.
Flashing	Red/Green	Operating with an active warning or alarm.
Flashing	Amber/Red	Shut down (not operating) because of an unacknowledged alarm.
Flashing	Red	Active warning or alarm present but unacknowledged.
Flashing	Blue	Liebert® iCOM™ display is starting-up or updating iCOM firmware.



11.2 Enabling Manual Mode for Diagnostics

Use manual mode to test components, validate operation, and evaluate performance.



NOTE: When manual mode is enabled, the cooling unit does not operate normally:

- Fan operation depends on the diagnostic category in use.
- Safety routines will prevent the use of some diagnostic features.
- Active alarms may prevent some the use of some diagnostic functions.
- In most cases, all components are turned-off.



NOTE: When manual mode is disabled, all components and the cooling unit return to normal operation. See [Disabling Diagnostics Manual Mode on the next page](#). Manual mode times-out after 30 minutes of inactivity and normal operation resumes.

1. Touch , then  > *Diagnostic/Service* > *Diagnostics* > *Manual Mode* in the Category list. The MANUAL MODE panel displays.
2. Touch the *Enable* check box in the upper-right of the *MANUAL MODE* panel. The *MANUAL MODE* confirmation dialog opens.
3. Touch *OK* to enable manual mode. *Enable* is checked and manual control for diagnostics enabled.
 - Touch *Cancel* to close the dialog and manual mode remains disabled.

11.2.1 Disabling Diagnostics Manual Mode

1. Touch , then  > *Diagnostic/Service* > *Diagnostics* > *Manual Mode* in the Category list. The MANUAL MODE panel displays.
2. Remove the check mark from the *Enable* box by touching it. Manual mode is disabled.

11.3 Diagnosing Evaporator Fan Issues

1. Touch , then  > *Diagnostic/Service* > *Diagnostics* > *Evaporator Fan* in the Category list. The EVAPORATOR FAN panel displays.
2. Refer to [Diagnostics—Evaporator Fan Options](#) below, for descriptions of diagnostic options.

NOTE: Depending on the type of thermal management unit, included components, and control settings of your system, all of the options listed may not be available on your Vertiv™ Liebert® iCOM™ display.

11.3.1 Diagnostics—Evaporator Fan Options

Analog Output 1

0V to 10V analog output that drives the speed of the evaporator fan. Typically, the evaporator fan is Analog Output 1 by default.

Analog Output 1 Selection

Var SpeedDrive.

Fan Speed

Current speed of fan.

Motors

Enables/disables fan motor during manual/diagnostic mode.

Status Airflow

Status of Air Safety Switch: Open or Closed.



Status Filter

Status of the air filter.

Status Remote Shutdown

Indicates whether remote shutdown is On or Off.

11.4 Diagnosing Compressor Circuit Issues

1. Touch , then  > *Diagnostic/Service* > *Diagnostics* > *Compressor Circuit N* (where N is the circuit number) in the Category list. The COMPRESSOR CIRCUIT panel displays.
2. Refer to [Diagnostics—Compressor Circuit Options](#) below, for descriptions of diagnostic options.

NOTE: Depending on the type of thermal management unit, included components, and control settings of your system, all of the options listed may not be available on your Vertiv™ Liebert® iCOM display.

11.4.1 Diagnostics—Compressor Circuit Options

Compressor Capacity

Enables/disables compressor capacity during manual/diagnostics mode.

Compressor Mode

Selects compressor operation during manual/diagnostics mode. Options are:

- 0: Run (normal operation)
- 1: Evacuate
- 2: Charge

Compressor Overload

Compress overload status.

Compressor State

Compressor status, On or Off.

High Pressure Alarm Code

Code of high pressure alarm. To address the alarm condition, see [Diagnosing EconoPhase Issues](#) on page 134.

- Zero: Okay
- Non-zero: High head pressure situation.

High Pressure Status

Status of compressor's high pressure switch.

Low Pressure Alarm Code

Code of low pressure alarm. To address the alarm condition, see [Resetting Low Pressure Alarm Code](#) on the next page.

- 0 (zero): Okay.
- Nonzero: Low suction pressure condition.

Low Pressure Status

Status of compressor's low pressure switch.



Status HT1

Count of times compressor is powered off for high scroll temperature.

11.4.2 Resetting High Pressure Alarm Code

When a high pressure problem has caused a compressor to lock off, resetting the High Pressure Alarm Code to zero unlocks the compressor for operation.

NOTE: Cycling main power of the cooling unit will also unlock the compressor.

1. Touch , then  > *Diagnostic/Service* > *Diagnostics* > *Compressor Circuit N* in the Category list (where N is the circuit number).
2. On the COMPRESSOR CIRCUIT panel, touch *Set to Zero* next to High Pressure Alarm Code, then touch *Save*. The code is reset and the compressor can now operate.



11.4.3 Resetting Low Pressure Alarm Code

When a low pressure problem has caused a compressor to lock off, resetting the Low Pressure Alarm Code to zero unlocks the compressor for operation.



NOTE: Cycling main power of the cooling unit will also unlock the compressor.

1. On the Service menu, touch *Diagnostic/Service* > *Diagnostics*. The DIAGNOSTICS panel opens.
2. Touch *Compressor Circuit N* in the Category list (where “N” is the circuit number).
3. On the COMPRESSOR CIRCUIT panel, touch *Set to Zero* next to Low Pressure Alarm Code, then touch *Save*. The code is reset and the compressor can now operate.

11.4.4 Resetting High-temperature Alarm Counter

1. Touch , then  > *Diagnostic/Service* > *Diagnostics* > *Compressor Circuit N* in the Category list (where “N” is the circuit number).
2. On the COMPRESSOR CIRCUIT panel, touch *Set to Zero* next to High Temperature Alarm Counter, then touch *Save*. The code is reset and the compressor can now operate.

11.5 Diagnosing Electronic Expansion Valve Issues

1. Touch , then  > *Diagnostic/Service* > *Diagnostics* > *Electronic Expansion Valve N* in the Category list. The ELECTRONIC EXPANSION VALVE panel displays.
2. Refer to [Diagnostics—Electronic Expansion Valve Options](#) on the facing page for descriptions of diagnostic options.

NOTE: Depending on the type of thermal management unit, included components, and control settings of your system, all of the options listed may not be available on your Vertiv™ Liebert® iCOM™ display.

11.5.1 Diagnostics—Electronic Expansion Valve Options

Current SH Setpoint

Setpoint for superheat.

EEV Batt Fail Counter C1

Number of battery test failures for the valve control board. To address the alarm condition, see [Resetting Electronic Expansive Valve Battery Failure Counter](#) on the next page .

Firmware Version

Current firmware data.

Manual Valve Control

Sets the valve open percentage during manual/diagnostics mode.

Manual Valve Control Enabled

Enables/disables manual control of the valve in manual/diagnostics mode.

Saturation Suction Temp

Saturated suction temperature of the refrigeration circuit.

Status Battery

Status of the battery on the valve control board.

Status EEV

Current status of the valve control board.

Suction Pressure

Current pressure at valve.

Suction Temp

Suction temperature of the refrigeration circuit.



Superheat

Current superheat reading of the refrigeration circuit.



Valve Opening

Current percentage that valve is open.

11.5.2 Resetting Electronic Expansive Valve Battery Failure Counter

1. Touch , then  > *Diagnostic/Service* > *Diagnostics* > *Electronic Expansion Valve N* in the Category list.
2. On the ELECTRONIC EXPANSION VALVE panel, touch *Set to Zero* next to EEV Batt Fail Counter, then touch *Save*. The counter is reset.

11.6 Diagnosing EconoPhase Issues

1. Touch , then  > *Diagnostic/Service* > *Diagnostics* > *EconoPhase* in the Category list. The ECONOPHASE panel displays,.
2. Refer to [Diagnostics—EconoPhase Options](#) below , for descriptions of diagnostic options.

NOTE: Depending on the type of thermal management unit, included components, and control settings of your system, all of the options listed may not be available on your Vertiv™ Liebert® iCOM™ display.

11.6.1 Diagnostics—EconoPhase Options

Pump Board N Firmware

Firmware version of the pump control board, where N is the pump number.

Pump Board Test

Runs a diagnostic test on the board.

Pump N Diff Pressure

Current differential-pressure reading, where N is the pump number.

Pump N Inlet pressure

Current inlet pressure reading, where N is the pump number.

Pump N Outlet Pressure

Current outlet pressure reading , where N is the pump number.



Pump N Speed

Current pump speed, where N is the pump number.

Pump N Test Results

Results of board test, where N is the pump number.

11.7 Diagnosing Digital Output Issues

1. Touch , then  > *Diagnostic/Service* > *Diagnostics* > *Digital Outputs* in the Category list. The DIGITAL OUTPUTS panel displays.
2. Refer to [Diagnostics—Digital Output Options](#) below for descriptions of diagnostic options.

NOTE: Depending on the type of thermal management unit, included components, and control settings of your system, all of the options listed may not be available on your Vertiv™ Liebert® iCOM™ display.

11.7.1 Diagnostics—Digital Output Options



Alarm Relay

Enables/disables alarms during manual/diagnostic mode.

Q15 Output State

Enables/disables Q15 output during manual/diagnostic mode.

11.8 Diagnosing Analog Output Issues

1. Touch , then  > *Diagnostic/Service* > *Diagnostics* > *Analog Outputs* in the Category list. The ANALOG OUTPUTS panel displays.
2. Refer to [Diagnostics—Analog Output Options](#) below, for descriptions of diagnostic options.



NOTE: Depending on the type of thermal management unit, included components, and control settings of your system, all of the options listed may not be available on your Liebert® iCOM™ display.

11.8.1 Diagnostics—Analog Output Options

Analog Output N

Controls analog outputs during manual/diagnostic mode. (*where N is the analog output number*)

11.9 Diagnosing Customer Input Issues

1. Touch , then  > *Diagnostic/Service* > *Diagnostics* > *Customer Inputs* in the Category list. The CUSTOMER INPUTS panel displays.
2. Refer to [Diagnostics—Customer Input Options](#) below , for descriptions of diagnostic options.

NOTE: Depending on the type of thermal management unit, included components, and control settings of your system, all of the options listed may not be available on your Vertiv™ Liebert® iCOM™ display.

11.9.1 Diagnostics—Customer Input Options

Input N



Status and description of customer-input sensors (where N is the input number).

12 Customizing Your Vertiv™ Liebert® iCOM™ Display

NOTE: Your Vertiv™ Liebert® DSE Packaged Solution does not offer humidification or dehumidification functions. Please disregard those settings/fields when mentioned in this guide or displayed on the Liebert® iCOM™ controller.

12.1 Setting General Display Properties

NOTE: You must be logged in to adjust the settings. See [Powering On Vertiv™ Liebert® iCOM™ and Logging In/Unlocking Controls](#) on page 6 .

1. Touch , then  > *Display Options* > *Display Properties*.
The DISPLAY PROPERTIES panel opens.
2. Touch a value to select the setting from the drop-down list
3. Touch *Save* to save the property settings.
 - Touch *Cancel* to discard changes.

12.1.1 Unit Display Options

Alarm Buzzer Pattern

Selects or disables the audible alarm notification. See [Enabling the Audible Alarm Notification](#) on page 55 .

Allow System On/Off

Enables/disables powering on/off the entire system of networked units from the Vertiv™ Liebert® iCOM™ display.

Backlight Brightness

Selects the brightness of the display back light.

Inactivity Timer

Time to elapse before display locks and dims.

Language

Selects the display language.

LED Brightness

Percentage brightness of the display.

Measurement System

Selects the units of measurement. Options are:

- Imperial (°F)
- Metric (°C)

Skin

Selects the color/background format of the user interface. Options are:

- Dark Blue
- White
- Dark Grey

Touch Beep

Enable/disable sound when display is touched.

Touch Shockwave

Enable/disable visual shockwave when display is touched.

Turn Unit On/Off without Password

When enabled, a Power On/Off button displays in the upper-right corner of the Vertiv™ Liebert® iCOM™ main display so personnel can turn the unit on or off with out logging-in and accessing the User/Service menus.



12.2 Customizing Main Display Views

The default Vertiv™ Liebert® iCOM™ display view is essentially a layout of two panels, one with status content and the other with alarms content. You can create custom display views by adding, changing, moving, and resizing the content objects.

NOTE: You must be logged-in to customize the view. See [Powering On Vertiv™ Liebert® iCOM™ and Logging In/Unlocking Controls](#) on page 6 .

12.2.1 Moving Content

You can drag and drop content objects anywhere you like on the main display.

1. Touch  , then .
2. Touch  in the upper right corner of the display and just below the control header.
3. Touch an object to select it (highlighted green), and drag it to the new location.

12.2.2 Resizing Content

You can resize content objects on the main display.



1. Touch  , then .
2. Touch  in the upper-right corner of the display and just below the control header.
3. Touch an object to select it (highlighted green), touch and drag a handle to resize the object. See **Figure 12.1** on the facing page .

Figure 12.1 Add/Remove Content Icons and Resizing Handles



Item	Description
1	Content adjustment icon
2	Resizing handles
3	Remove content icon

12.2.3 Adding and Adjusting Content

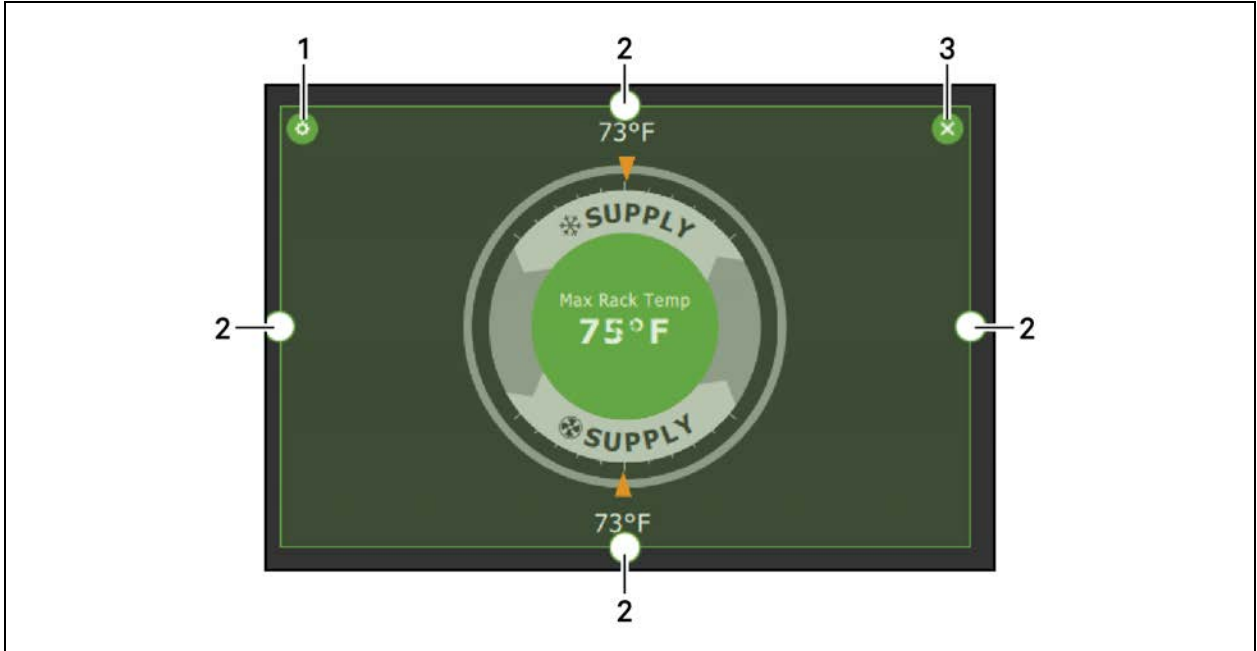
You can add a variety of content to the main display.









1. Touch , then .
2. Touch  in the upper-right corner of the display and just below the control header, then touch . A menu of content options opens, described in **Table 12.1** on the next page.
3. Touch the Move icon next to the content and drag it onto the display, then use the resize handles to adjust as needed.
4. To adjust the content object or the way it displays, touch , see **Figure 12.1** above.

Table 12.1 Main User Display Content Options

Content	Description
Separator	Separating line to place between content sections. You can adjust the thickness and orientation of the separator.
Dial	Status dial. You can select the sensor readings displayed in the center of the status dial when you touch to scroll through the readings.
Setpoint Readout	Displays the current reading of a connected sensor, for example: Return temperature at 72°F.
Setpoint Bar	Displays a bar graph for a selected setpoint with customizable empty and full limits. For example, if a temperature setpoint bar is empty at 60°F and full at 80°F, and the reading is 70°, the graph will be filled half way.
Sensor Bar	For remote sensors only, functions the same as the setpoint bar, but only offers connected remote sensors, and displays the customer-assigned name of the sensor next to the graph.
Shortcut	Shortcut opens panels directly instead of browsing through menus. You can select the destination of the shortcut, whether or not an icon displays, and the size, label, and frame of the shortcut.
Alarms	Alarms panel. You can select whether or not the information may be exported.
Event Log	Event log panel. You can select whether or not the information may be exported.
Run Hours	Run hours panel. Summary of the component run hours and limits.
EconoPhase Diagram	EconoPhase operating diagram.
EconoPhase Status	Compressor/Econophase status bar. Indicates the operating mode and the percentage at which the component is operating.

12.2.4 Removing Content



You can easily remove content from the main display.

1. Touch , then .
2. Touch  in the upper right corner of the display and just below the control header.
3. Touch an object to select it (highlighted green), then touch , see **Figure 12.1** on the previous page .

12.3 Customizing Parameter and Field Labels

You can customize header labels for parameters in the menus and you can customize field names.

NOTE: You can export labels for back up or to use a text editor to customize the labels. See [Exporting, Importing, and Customizing Labels Using a Text Editor](#) on page 142 .

1. Before going to the customization panel, use the search box and on screen keyboard to find the label(s) that you want to customize. Once you know where they are, you'll be able to find them in the categories on the Customize Labels panel.
2. Touch , then  > *Display Options* > *Custom Labels*.
The CUSTOM LABELS panel opens. The labels are divided into “categories” that represent the names of menus, sub-menus and screen panels.

3. Locate the category that contains the label(s) to customize that you determined in step 1, and touch to expand it.
4. In the Custom Text column, touch the text box to edit, make changes and touch . See **Figure 12.2** below, for an example of changing the column names for Property and Value (in the Analog Inputs panel) to Input and Configuration.
 - Touch *Cancel* to discard the change.
5. When finished editing labels, make sure the Enable Custom Labels is selected (or your updates will not display), and touch Save.

The label(s) are updated. **Figure 12.3** on the next page, shows the Analog Input Properties panel with the custom labels that replaced Property and Value.

Figure 12.2 Custom Text for the Analog Input Properties Labels

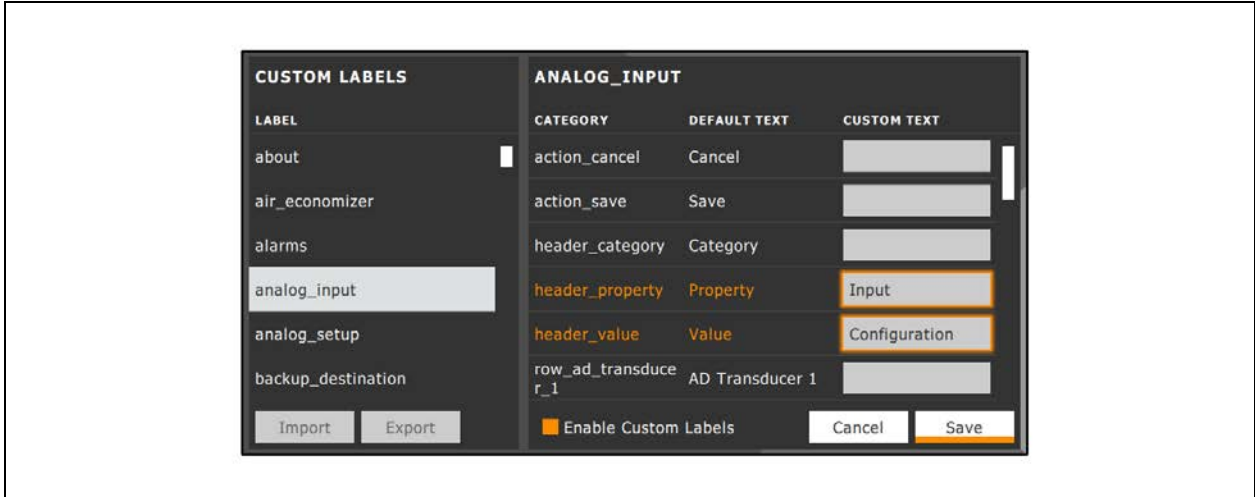
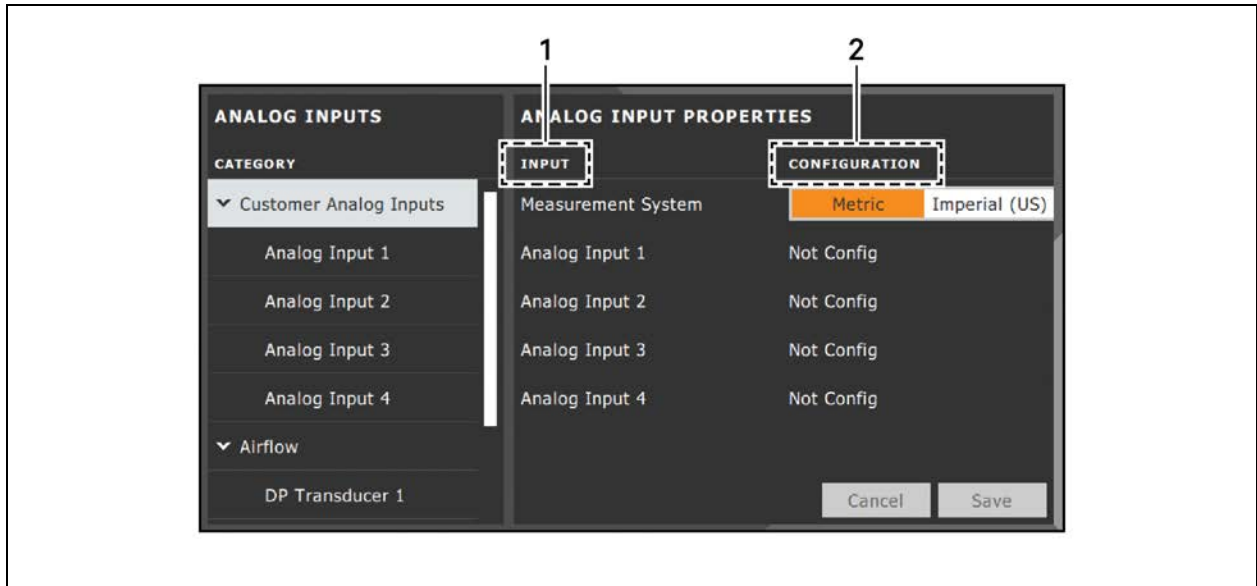

Figure 12.3 Customized Label Text on Analog Input Properties Panel



Item	Description
1	Former Parameter heading is now Input.
2	Former Value heading is now Configuration.

12.3.1 Exporting, Importing, and Customizing Labels Using a Text Editor

You can export custom label settings to a text file for back-up or to modify the labels using a text editor. The text file is exported and imported using a USB drive.

1. Insert a USB drive into an open USB port on the rear of the touchscreen display, then navigate to the Custom Labels panel and touch *Export*. The EXPORT FILE dialog opens, and the connected USB drive is automatically detected.
 - If “No USB devices are available” displays, check the connection or try reinserting the drive.
2. Touch *Name* and type a descriptive name for the file, then touch *Go*.
3. Touch *Export* and wait at least 15 seconds, then you can remove the USB drive.
4. Insert the USB drive into a PC or laptop and locate the file, which is named with the Name you entered and the extension “.cl.txt.” For example, if you named your export “MyLabels,” the file will be MyLabels.cl.txt.
5. Open the file in a text editor. The file contains all of the labels available for customization listed with the menu/panel on which the label is located, the label identifier, and an equal sign (=) as shown in the following example:

NOTE: You must use an editor that interprets Linux line endings, otherwise all of the lines will run together. For example, Microsoft WordPad will interpret the Linux line endings, but Microsoft Notepad will not.

```
analog_input/row_customer_analog_inputs=Unit A Inputs
analog_input_properties/header_property=Property
analog_input_properties/header_value=Value
```

6. To customize, type a new label name to the right of =, and save the text file. The following example will result in the same custom labels shown in **Figure 12.3** on the previous page.

```
analog_input/row_customer_analog_inputs=Unit A Inputs
```

```
analog_input_properties/header_property=Input
```

```
analog_input_properties/header_value=Configuration
```

7. Remove the USB drive with the updated/saved text file from the PC/laptop, insert it into an open USB port on the rear of the touchscreen display, then navigate to the Custom Labels panel and touch *Import*.
8. Locate the updated text file in the drop-down list, and touch *Import*.
The dialog closes and the customizations display on the menus and panels that you updated.

This page intentionally left blank

13 Hardware Installation

Your unit includes the Vertiv™ Liebert® iCOM™ controller. This section describes the installation of connections and cabling to fully utilize the Liebert® iCOM™ features.

NOTE: Your Vertiv™ Liebert® DSE Packaged Solution does not offer humidification or dehumidification functions. Please disregard those settings/fields when mentioned in this guide or displayed on the Liebert® iCOM™ controller.

13.1 Installing Wired Remote Sensors

Up to 10 remote sensor modules, installed in the monitored racks and connected to the cooling unit, provide control and reference input to Vertiv™ Liebert® iCOM™ and building-management systems. Using remote, rack sensors combats cooling problems related to recirculation air, uneven rack loading, and air distribution.

The sensor array consists of 2T sensors that each have two temperature probes on a 6 ft (1.8 m) probe-connection cable, **Figure 13.1** below, and requires several steps to prepare, connect, and begin monitoring the racks:

- Set DIP switches in each sensor.
- Terminate final sensor on CANbus link.
- Install sensors on racks.
- Install CANbus cabling between sensors.
- Connect CANbus cable to the cooling unit.
- Configure the sensors in Liebert® iCOM.

NOTE: The 2T sensor shown in Figure 13.1 below, may differ slightly for your system, depending on equipment installed.

Figure 13.1 2T Sensor for Rack Monitoring



13.1.1 Setting DIP Switches and Labeling 2T Sensors

Tools required:

- Small non-conductive tool to set switches
- Small Phillips head screw driver to open 2T housing.

Each sensor requires a unique address in the CANbus loop connected to the cooling unit. We recommend that you set the DIP-switch sensor-number setting to correspond to the sensor's location on the CANbus run. If settings are incorrect, the control will not operate properly.

NOTE: Sensors are connected in a daisy chain via CANbus cabling to the cooling-unit control board. You can extend the sensor network (up to 10) by adding sensors to the end of the chain and adjusting the termination settings. Do not run individual wires from the sensors to the cooling unit.

1. Apply numbered stickers to the sensor housing that corresponds to the sensor’s position in the chain.
2. Locate the DIP-switch hole on the rear of the sensor housing, **Figure 13.2** below .

– or –

If the hole is not present, or the settings are difficult to make through the hole, remove the cover by removing the Phillips-head screws (typically 3). See **Figure 13.2** below .

NOTE: Use the non-conductive DIP-switch tool (included) or a similar tool to set switches. Do not insert any metal object into the sensor case.

Figure 13.2 DIP Switch Opening/DIP Switches Inside of 2T Sensor

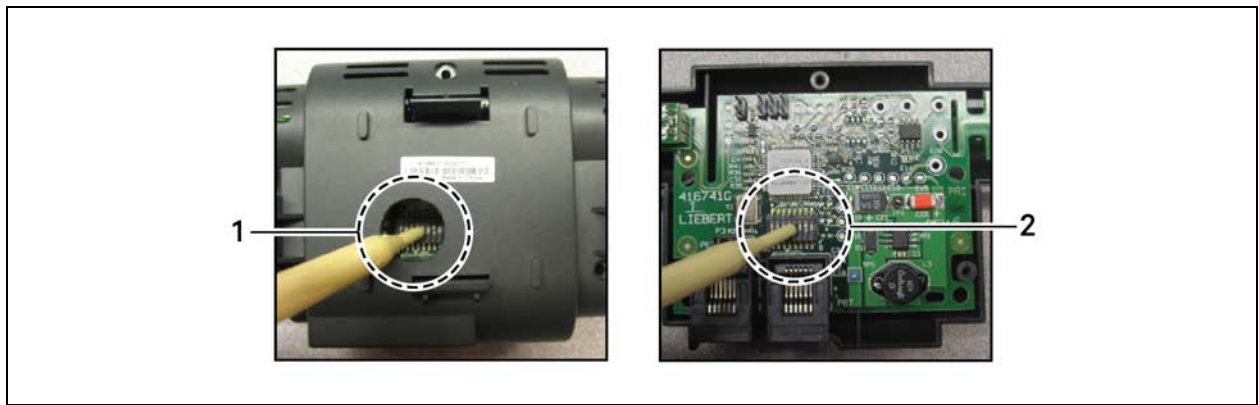

Item	Description
1	Hole in sensor housing
2	Cover removed

- Referring to **Table 13.1** below, and using the non-conductive tool, set the DIP switches for each sensor to its number in the chain (from sticker applied in step 1).

Figure 13.3 below, shows a representation of the DIP switches.

- Confirm that the DIP switches are set correctly for each sensor, and replace the housing cover if necessary.

Table 13.1 DIP Switch Settings for Wired Remote Sensors

2T sensor number/address	DIP-switch position							
	1	2	3	4	5	6	7	8
1	Off	Off	On	Off	On	Off	Off	Off
2	On	Off	On	Off	On	Off	Off	Off
3	Off	On	On	Off	On	Off	Off	Off
4	On	On	On	Off	On	Off	Off	Off
5	Off	Off	Off	On	On	Off	Off	Off
6	On	Off	Off	On	On	Off	Off	Off
7	Off	On	Off	On	On	Off	Off	Off
8	On	On	Off	On	On	Off	Off	Off
9	Off	Off	On	On	On	Off	Off	Off
10	On	Off	On	On	On	Off	Off	Off

NOTE: Up is on, down is off on the DIP switch.

Figure 13.3 DIP Switches in 2T Sensor

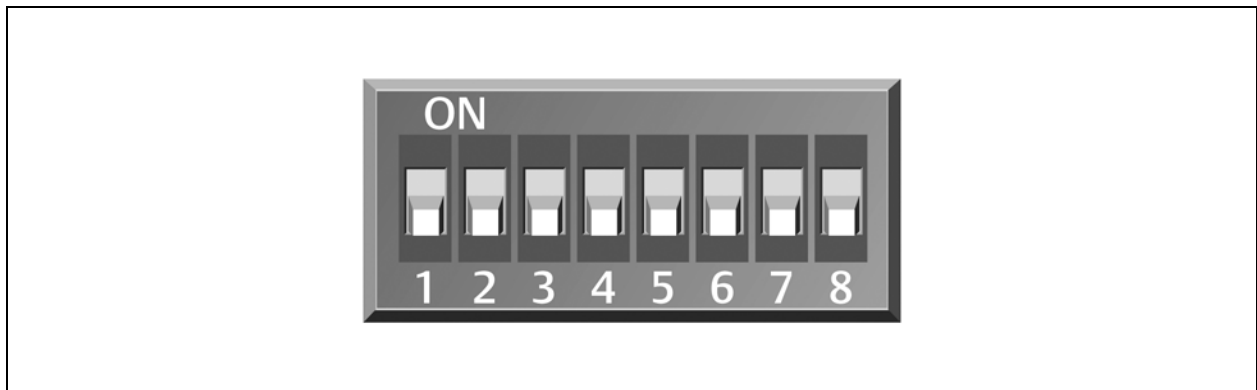

13.1.2 Terminating the Last Sensor on the CANbus Link

The 2T sensor need not be installed in the numeric order of their address/sensor number (although it may be easier for later maintenance). However, the last sensor in the chain must be terminated. All others must remain unterminated. We also recommend that you make a record of the sensor numbers along with the name/number of the rack on which they are installed. **Figure 13.4** on the next page, shows an example CANbus arrangement.

NOTE: To add sensors, unterminate final sensor, add sensors to the chain, and terminate the new final sensor.

Figure 13.4 Example Sensor CANbus Arrangement

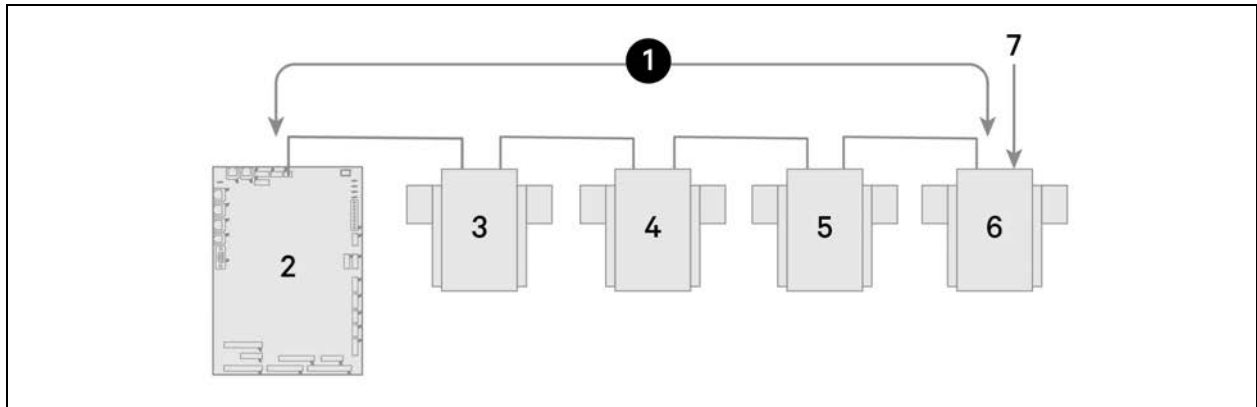

Item	Description
1	CANbus communication loop
2	iCOM control board
3	2T sensor
4	2T sensor
5	2T sensor
6	2T sensor
7	Terminated sensor

To terminate the last sensor:

1. Locate the sensor that will be last on the network.

NOTE: The last sensor on the network will be the sensor with only 1 CAN cable after all sensors are connected to the CANbus network. See [Connect the CANbus Cable and Ground](#) on page 152 .

2. Open the sensor's case by removing the Phillips-head screws (typically 3) on the rear of the housing to access the jumper used for terminating.
3. Remove the black jumper from pins 1 and 2 on the P3 pin connector, and install it on pins 2 and 3 as shown in **Figure 13.5** on the facing page .
4. Replace the sensor cover.
The 2T sensor is terminated in the CANbus link.

Figure 13.5 Termination Jumper on 2T Circuit Board

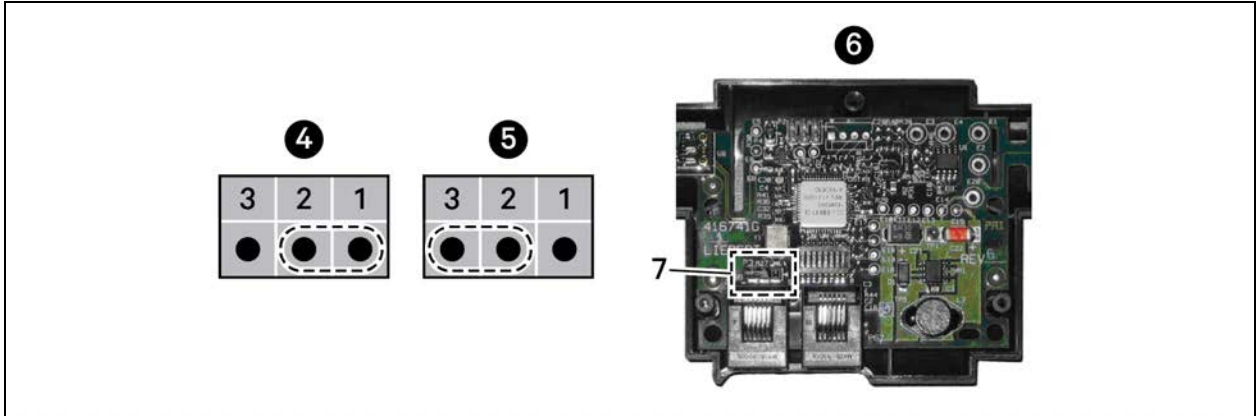

Item	Description
1	Position 1 (P3 jumper)
2	Position 2 (P3 jumper)
3	Position 3 (P3 jumper)
4	Unterminated
5	Terminated
6	Rear of sensor, cover removed
7	P3 termination jumper

13.1.3 Installing 2T Sensors in the Racks to Monitor

Tools required:







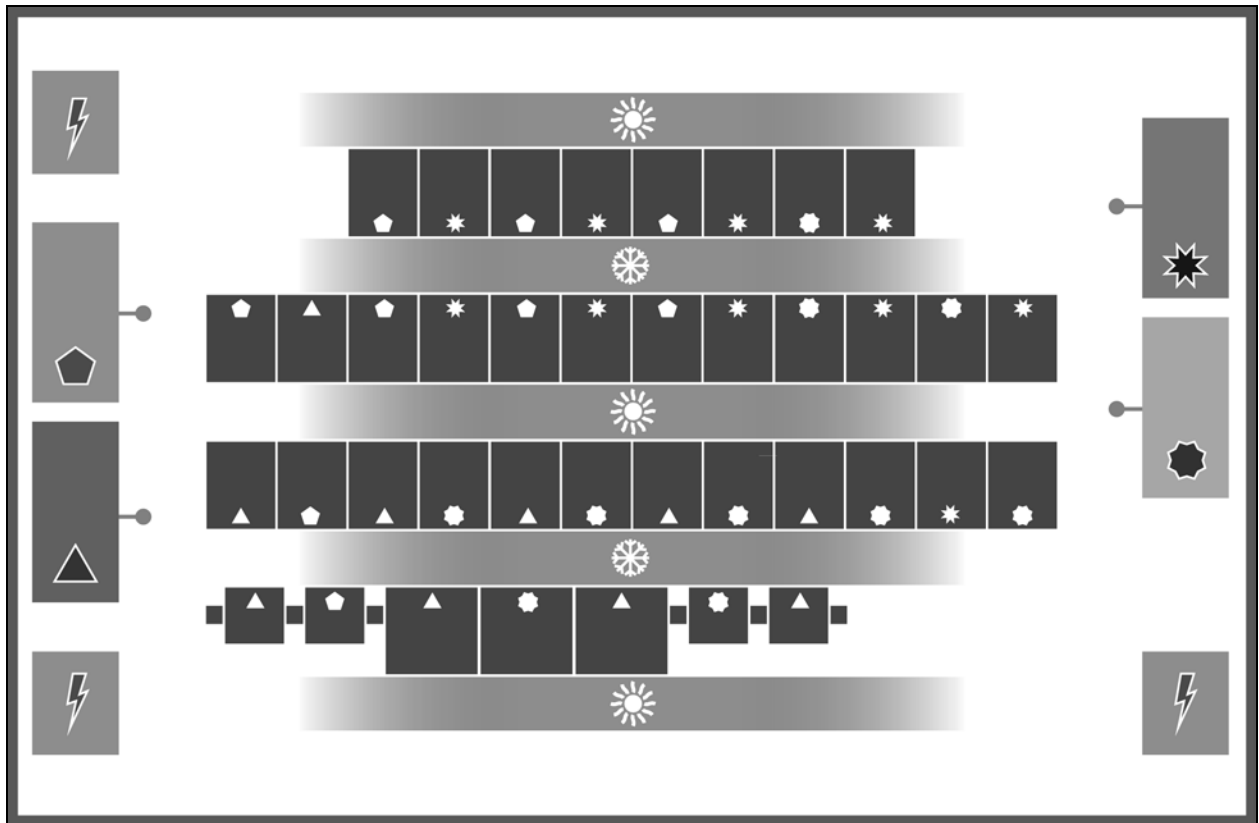

- Medium, flat head screw driver to open electric panel dead front
- Cutting tool to trim cable ties

The cooling units and rack sensors in **Figure 13.6** below are symbol coded to show how interlacing sensors from different cooling units provides redundancy and effective operation by sharing sensor data from the cooling units in Teamwork mode.

NOTE: Even though your DP Packaged Unit is located outside the conditioned area, the sensor placement still applies.

Figure 13.6 Interlacing Sensor Placement



Item	Description	Item	Description
	Unit 1		Cold aisle (front of racks)
	Unit 2		Hot Aisle (rear of racks)
	Unit 3		Supply (discharge) temperature sensor
	Unit 4		Power distribution unit

To install the sensors on the racks:

NOTE: Do not leave sensor probes coiled on top or coiled inside a rack. Do not install a sensor in the hot aisle, or if a sensor is installed in the hot aisle, make sure that it is set to "reference" to ensure that its readings are not used for fan or cooling control.

- 1. Install the inlet-rack temperature sensors on a rack in the area cooled by its connected unit as shown in **Figure 13.7** below .

Figure 13.7 Rack Sensor Placement

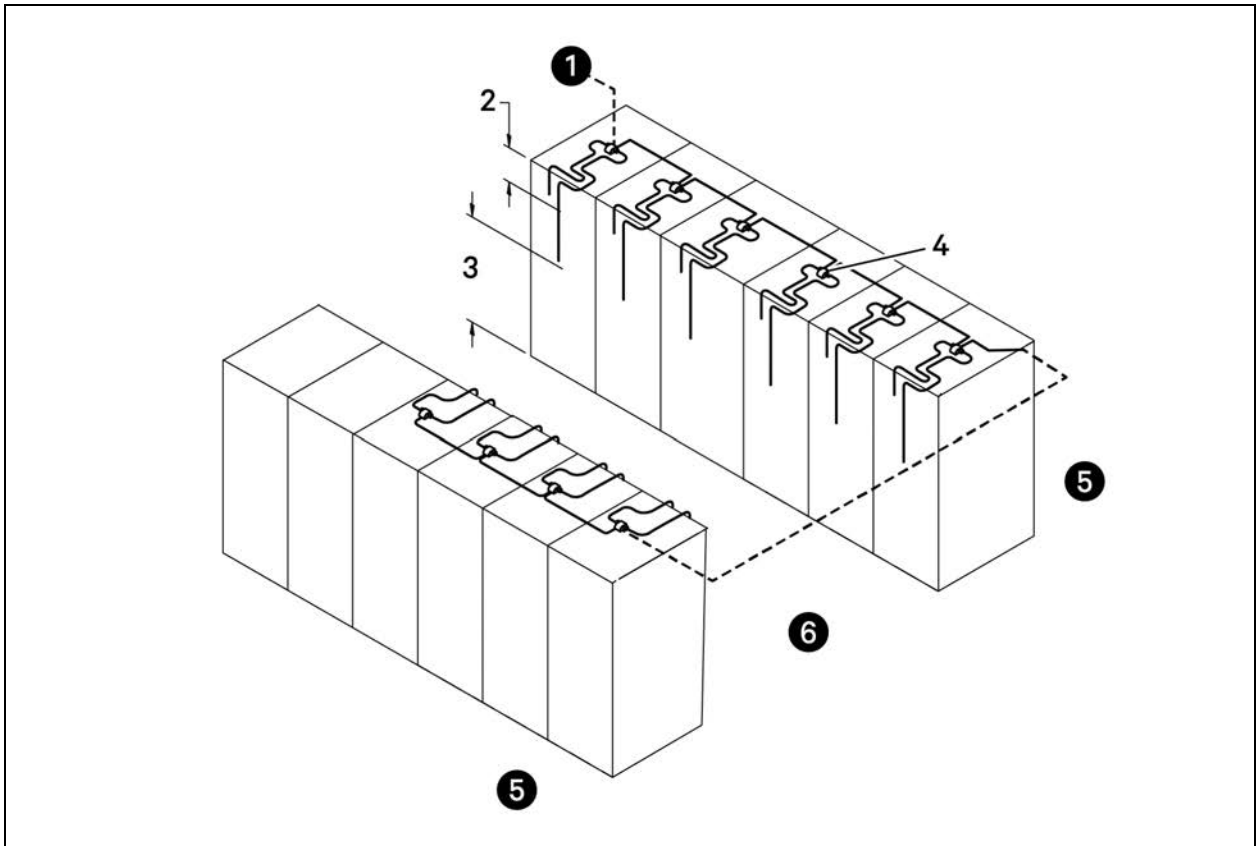

Item	Description
1	To cable entry in cooling unit
2	First probe, 12 in. (305 mm) from top
3	Second probe, in approximate center of rack and in front of the equipment
4	2T sensor with label visible
5	Hot aisle
6	Cold aisle

NOTE: Both probes on the 2T sensor must be installed on the same rack.

2. Install the 2T sensor probes the front door of the rack:
 - a. Using a cable tie, secure the sensor wire so that a probe is approximately 12 in. (305 mm) from the top and in the center of the front door.
This sensor monitors hot air coming over the top of the rack from the hot aisle.

NOTE: Do not wrap cable ties around the actual sensor probe. If the rack has no door, secure the probes to the rack at the side of the front opening.

- b. Use a cable tie to secure the sensor wire of the second probe to the front door so that it is centered in front of the heat generating equipment drawing air.

If the cabinet is completely filled with equipment, determine the center based on cabinet width and height.
 - c. With probes in place, use cable ties to route the wires neatly up the rack door and into the rack leaving enough slack in the wire so that the rack door opens and closes without binding or pinching the wire.
 - d. Using the supplied hook and loop fastener, connect the 2T sensor housing to the rack in an easily-accessible location and with the sensor number visible.
3. Repeat step 2 until all sensors are installed.

13.1.4 Connect the CANbus Cable and Ground



WARNING! Risk of electric shock. Can cause equipment damage, injury or death. Open all local and remote electric power supply disconnect switches and verify with a voltmeter that power is off before working within any electric connection enclosures. Service and maintenance work must be performed only by properly trained and qualified personnel and in accordance with applicable regulations and manufacturers' specifications. Opening or removing the covers to any equipment may expose personnel to lethal voltages within the unit even when it is apparently not operating and the input wiring is disconnected from the electrical source.

Cabling considerations:

- For cable up to 150 ft (45 m) long, no special considerations are needed.
- Cable 150 ft (45 m) to 300 ft (91 m) require a CANbus isolator.
- For cable longer than 300 ft (91 m), contact the factory.
- The CANbus cable network requires a ground wire.

To connect the cables:

1. Connect CANbus cable and a ground wire between each sensor for the cooling unit, **Figure 13.8** below , taking the following precautions:

NOTE: Remember that the last sensor on the chain must be terminated as described in [Terminating the Last Sensor on the CANbus Link](#) on page 147 .

- Use only approved hangers, and do not secure cables in a way that could damage them.
- Limit bends to less than four times the diameter of the cable.
- When securing and hanging, avoid deforming the cable.
- Keep cables away from devices that may cause interference such as high-voltage wires, machinery, fluorescent lights and electronics.

NOTE: High voltage sources must be at least 12 in. (305 mm) from CAN wires.

- Avoid stretching cables.
- Avoid using excess cable between sensors.
- Make sure that cables have the correct pin-out. Mismatched pins at the RJ2 connection will damage the CAN device.

Figure 13.8 CANbus and Ground Connection on 2T Sensor



2. Terminate the ground wire to a field-installed ground ring in the low-voltage electrical panel, as shown in **Figure 13.9** below .
3. Connect the CANbus cable to the cooling unit. On most cooling units, the connection points for the CANbus link are P66 and P67.

Figure 13.9 Ground Wire Ring Connection

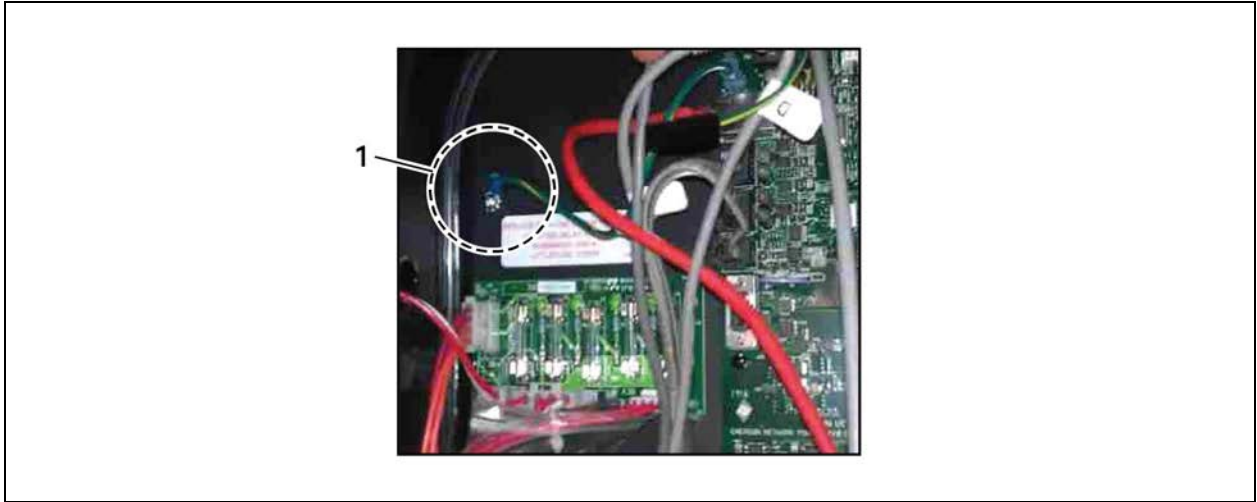

Item	Description
1	CANbus cable grounding ring connected to grounding screw in unit.

13.2 Installing a Fluid Temperature Sensor

1. Locate the DIP switches in the 2T sensor(s) by removing rear housing or via pre-cut hole in housing, **Figure 13.10** on the facing page , and program according to **Table 13.2** below . **Figure 13.11** on the facing page , shows the switch and on/off setting.

Table 13.2 DIP Switch Settings in 2T Sensors

	CANbus Node ID	DIP Switch position							
		1	2	3	4	5	6	7	8
Fluid circuit 1	30	Off	On	On	On	On	Off	Off	Off
Fluid circuit 2	31	On	On	On	On	On	Off	Off	Off

Circuit 1 and 2 fluid sensors are dual-purpose CANbus IDs in firmware. These sensors might also be used for monitoring supply temperature. Before installing fluid temperature sensors, determine whether or not the supply temperature 2T sensors are in use. Adding duplicate sensors will cause sensor communication loss.

Figure 13.10 Locating DIP Switches in 2T Sensor

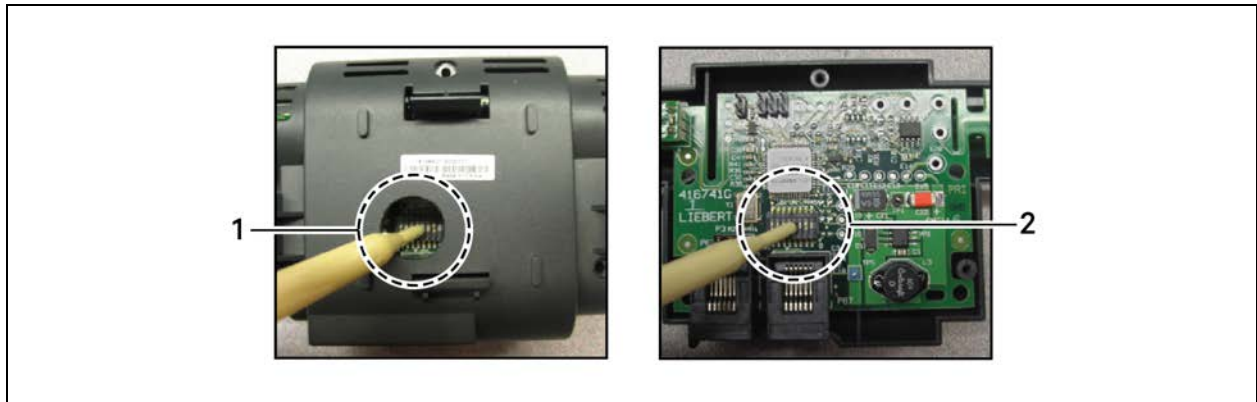

Item	Description
1	Hole in sensor housing
2	Cover removed

NOTE: Up is on, down is off on the DIP switch.

Figure 13.11 DIP Switches in 2T Sensor

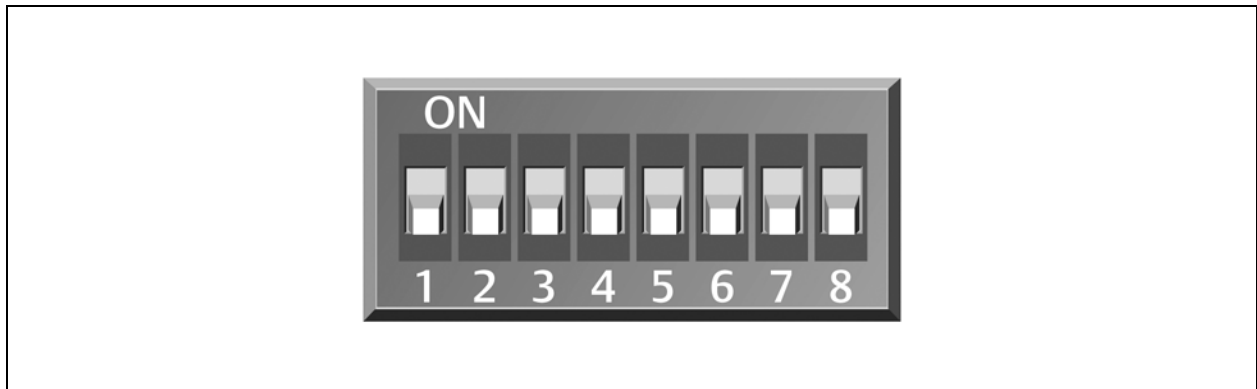

2. Once DIP switches are set, refer to [Terminating the Last Sensor on the CANbus Link](#) on page 147, then continue with step 3.
3. On Vertiv™ Liebert® iCOM™:
 - In the Service menu, touch *Auxiliary Device Setup* > *Sensors* > *Fluid Sensors* > *Fluid 2T SensorCW T*. The SENSOR PROPERTIES panel opens.
 - In *Fluid Sensor Type*, select the type of 2T sensor.
4. At the fluid inlet and outlet, use a field-supplied temperature sensor to verify the temperature readings, compare the Liebert® iCOM™ readings to the actual measured temperatures, and calibrate as needed.
 - If inlet and outlet temperature readings in Liebert® iCOM™ are reversed based on the field measurements, use Fluid Sensor 1/2 Placement to swap the readings.
5. Touch Save. The fluid temperature sensor settings are saved.

13.3 Installing Supply Control Sensors

13.3.1 Installing the Supply Air Temperature Sensor

The supply temperature sensor is connected to P8, Pins 1 and 2 at the factory require no configuration.

1. Place the sensor in an area that is influenced only by the unit to which it is connected to provide an accurate reading: 5 ft. to 15 ft. (1.5 m to 4.5 m) from the cooling unit, **Figure 13.12** below .

NOTE: A 50 ft. (15 m) extension cable is available from Vertiv if the sensor must be more than 15 ft. (4.5 m) from the Vertiv™ Liebert® iCOM™ unit.

2. Confirm connectivity via SENSOR DATA. See [Viewing Sensor Data](#) on page 17 .

Figure 13.12 Placement of the Supply Air Temperature Sensor

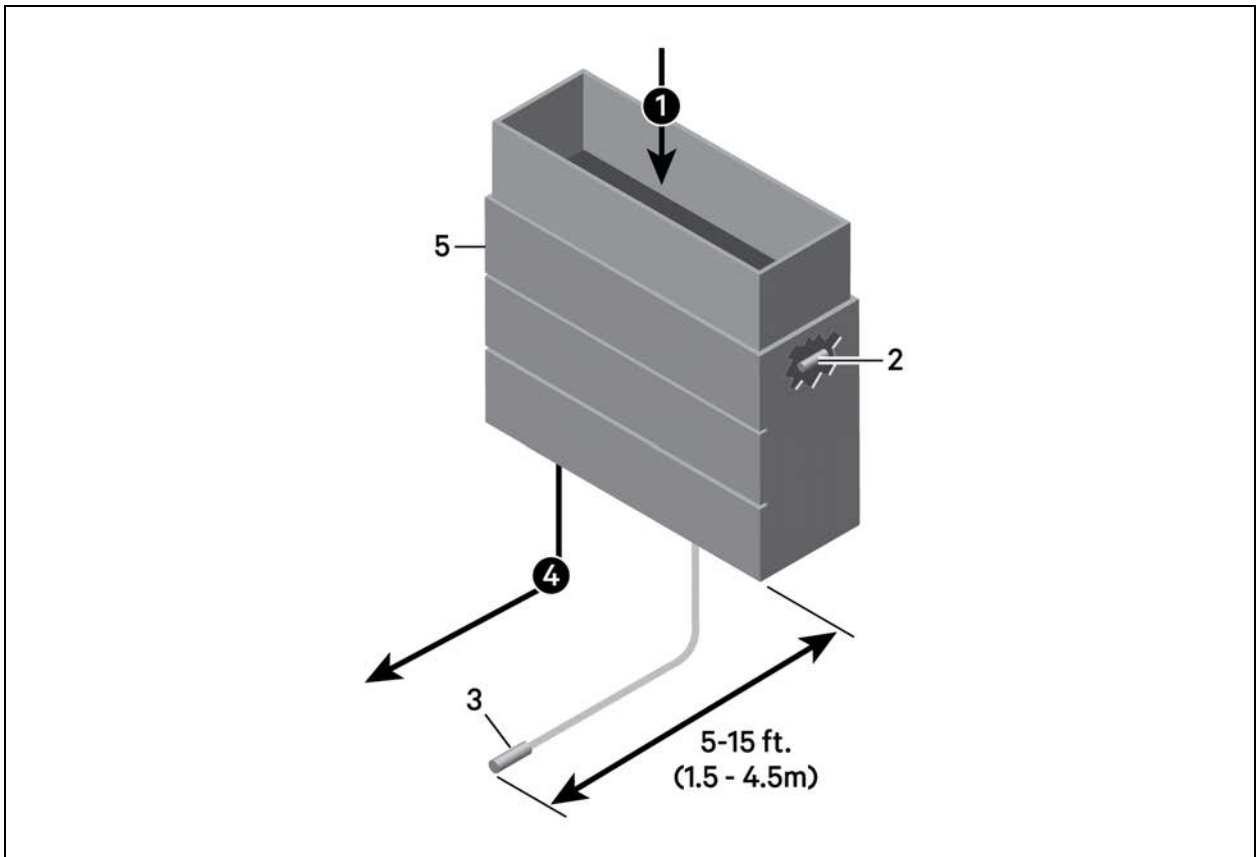

Item	Description
1	Return air
2	Internal temperature/humidity sensor
3	Temperature sensor
4	Supply air
5	Liebert® Thermal Management unit

13.3.2 Installing Aggregated Supply Air Temperature Sensors

On systems with large supply air plenums, up to five additional 2T sensors may be connected (via CANbus) in addition to the standard supply air sensor. Vertiv™ Liebert® iCOM™ then aggregates the readings and converts to average or maximum values for supply control.

NOTE: The 2T sensors used for supply air sensor aggregation are identical to the wired-remote sensors and are added in addition to the up to 10 remote sensors. You may install the supply air sensors at the end of the wired remote CANbus link or as a separate CANbus loop tied back to the control board and properly terminated.

The sensor array consists of 2T sensors that each have two temperature probes on a 6 ft (1.8 m) probe connection cable and requires several steps to prepare, connect, and begin monitoring the racks:

- Set DIP switches in each sensor.
- Terminate final sensor on CANbus link.
- Install sensors.
- Install CANbus cabling between sensors.
- Connect CANbus cable to the cooling unit.
- Configure the sensors in Liebert® iCOM™.

Setting DIP Switches and Labeling Supply Air Sensors

Supply sensors A through E have dual purpose CANbus node IDs in Vertiv™ Liebert® iCOM™ software and may be alternately used for air temperature/humidity monitoring or fluid temperature monitoring. **Table 13.3** on the next page, indicates the Node IDs and the alternate use.

Once installed, Liebert® iCOM™ recognizes the as supply air sensors, distinguished from the wired remote sensors that may be in use. Before installing the supply air sensors, make sure that the CANbus node IDs are not already in use. Duplicate sensors will cause loss of sensor communication.

Tools required:

- Small non-conductive tool to set switches
- Small Phillips head screw driver to open 2T housing.

Each sensor requires a unique address on the CANbus cable connected to the cooling unit. We recommend that you set the DIP switch sensor-number setting to correspond to the sensor's location on the CANbus run. If settings are incorrect, the control will not operate properly.

NOTE: Sensors are connected in a daisy chain to the cooling unit control board. Do not run individual wires from the sensors to the cooling unit.

1. Apply numbered stickers to the sensor housing that corresponds to the sensor's position in the chain.
2. Locate the DIP switch hole on the rear of the sensor housing, **Figure 13.13** on the next page.

– or –

If the hole is not present, or the settings are difficult to make through the hole, remove the cover by removing the Phillips head screws (typically three).

NOTE: Use the non-conductive DIP switch tool (included) or a similar tool to set switches. Do not insert any metal object into the sensor case.

Figure 13.13 DIP Switch Opening/DIP Switches Inside of 2T Sensor

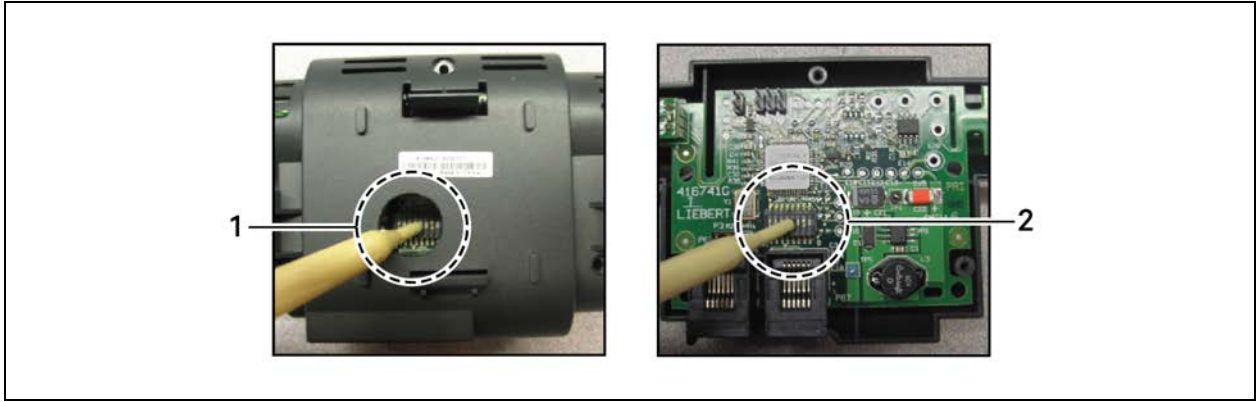

Item	Description
1	Hole in sensor housing
2	Cover removed

3. Referring to **Table 13.3** below, and using the non-conductive tool, set the DIP switches for each sensor to its number in the chain (from sticker applied in step 1).

Figure 13.14 on the facing page, shows a representation of the DIP switches.

4. Confirm that the DIP switches are set correctly for each sensor, and replace the housing cover if necessary.

Table 13.3 DIP Switch Settings for Supply Air Aggregation Sensors

Sensor Number/Address	DIP Switch Position								CANbus Node ID	Alternate Use
	1	2	3	4	5	6	7	8		
A	On	Off	Off	Off	On	Off	Off	Off	17	Temperature/Humidity
B	Off	On	Off	Off	On	Off	Off	Off	18	Temperature/Humidity
C	On	On	Off	Off	On	Off	Off	Off	19	Temperature/Humidity
D	Off	On	On	On	On	Off	Off	Off	30	Fluid inlet/outlet temperature
E	On	On	On	On	On	Off	Off	Off	31	Fluid inlet/outlet temperature

NOTE: Up is on, down is off on the DIP switch.

Figure 13.14 DIP Switches in 2T Sensor

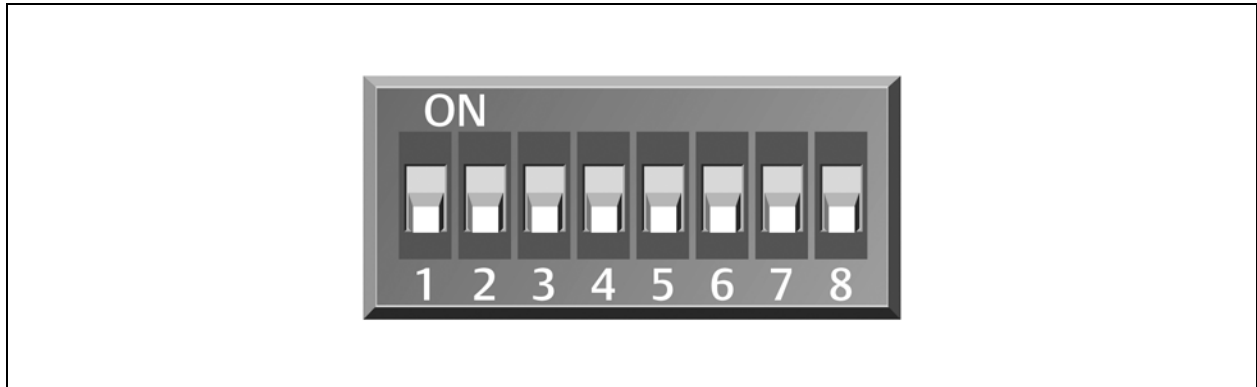

Terminating the Last Supply Air Sensor on the CANbus Link

The 2T sensor need not be installed in the alphabetic order of their address/sensor letter (although it may be easier for later maintenance). However, the last sensor in the chain must be terminated. All others must remain unterminated. We also recommend that you make a record of the sensor numbers along with the name/location of the equipment on which they are installed.

To terminate the last sensor:

1. Locate the sensor that will be last on the CANbus link.

NOTE: The last sensor on the network will be the sensor with only one CAN cable after all sensors are connected to the CANbus network.

2. Open the sensor's case by removing the Phillips head screws (typically three) on the rear of the housing to access the jumper used for terminating.
3. Remove the black jumper from pins 1 and 2, and install it on pins 2 and 3 as shown in **Figure 13.15** on the next page .
4. Replace the sensor cover. The 2T sensor is terminated in the CANbus link.
5. If installing in an existing CANbus link, remember to unterminate the sensor that was previously last.

Figure 13.15 Termination Jumper on 2T Circuit Board

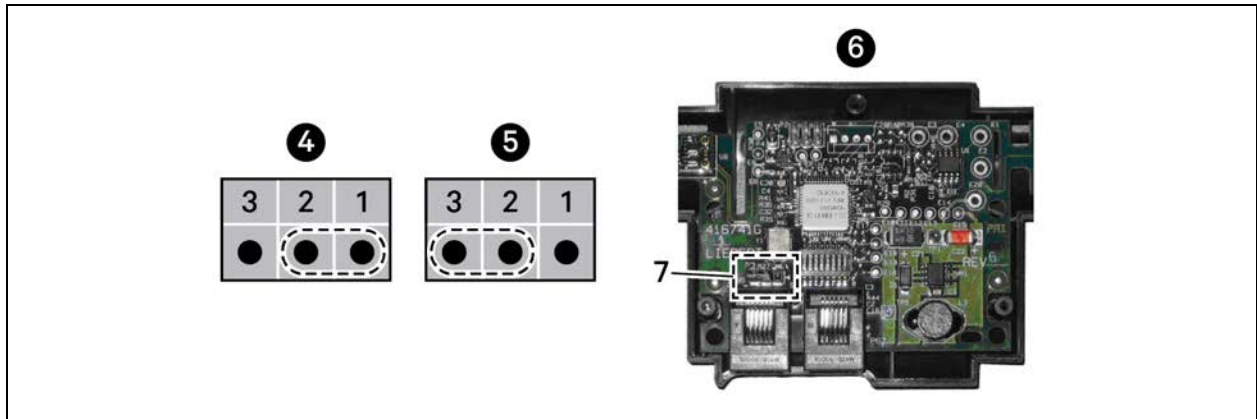

Item	Description
1	Position 1 (P3 jumper)
2	Position 2 (P3 jumper)
3	Position 3 (P3 jumper)
4	Unterminated
5	Terminated
6	Rear of sensor, cover removed
7	P3 termination jumper

13.4 Installing Analog Input Devices

External sensors and analog devices may be connected to Vertiv™ Liebert® iCOM™ using an electrical connection on the iCOM control board to a required, factory supplied plug, harness and terminal strip. (Contact Vertiv technical support for parts.)

When equipped, devices as follows can be connected to terminals 41, 42, 43 and 44, 45 and 46, or 47 and 48. **Table 13.4** below, lists available analog inputs depending on the type of cooling unit.

See [Configuring Analog Input Devices](#) on page 121, to configure the Liebert® iCOM™ settings for the device.

Table 13.4 Number of Analog Inputs Available by Cooling Unit Type

Cooling unit	Inputs available
Vertiv™ Liebert® CW and Vertiv™ Liebert® PCW with MBV	4 2 may be used for valve feedback on CW, 1 on Liebert® PCW.
Liebert® CW and Liebert® PCW with 3P (floating point actuator)	4 2 may be used for valve feedback on CW, 1 on Liebert® PCW.
Vertiv™ Liebert® DS and Vertiv™ Liebert® DSE Air-cooled	2 Both used for low pressure transducers.

Table 13.4 Number of Analog Inputs Available by Cooling Unit Type (continued)

Cooling unit	Inputs available
Liebert® DS Water/Glycol Cooling	0 Models without high pressure transducers may have 2.
Vertiv™ Liebert® PDX™ Air-Cooled	3 1 is used for low pressure transducers.
Liebert® PDX Water/Glycol Cooled	2 1 is used for a low pressure transducer. Optionally, a second for a high pressure transducer.

13.5 Installing the Unit to Unit Network

13.5.1 Required Network Equipment

Ethernet cable CAT5 or greater

- Maximum cable length is 328 ft (100 m).
- An Ethernet repeater is required for cable lengths greater than 328 ft (100 m).

Network switch

- IEEE 802.3; IEEE 802.3u
- 10/100 Mbps speed
- Multiple 10/100 RJ-45 ports, one shared.
- RJ-45 up link port

NOTE: Up to 32 cooling units may be connected in a unit to unit (U2U) network.

13.5.2 Planning Wiring Runs

When planning the layout of the conditioned space, consider the following:

- Good wiring practices.
- An Ethernet repeater is required for cable lengths greater than 328 ft (100 m).
- A private network that only connects and manages the cooling units is required.
- Keep control and communication cables away from power cables to prevent electromagnetic interference.
- Keep cables away from noise introducing device such as machines, fluorescent lights and electronics.
- Do not bend cables to less than four times the diameter of the diameter of the cable.
- Do not deform cables when hanging or securing in bundles.
- Do not exceed 25 lb (11 kg) of tension when pulling cables to avoid stretching.
- Do not damage cables when securing them. Use only approve hangers, such as telephone wire/RG-6 coaxial-wire hangers.

13.5.3 U2U Wiring Connection

NOTICE

Cooling units are factory wired for stand-alone operation. Do not connect the U2U network cabling before setting the U2U network configuration/groups. Network communication conflicts and un-reliable display readings will result.

Before you begin, refer to [Preparing for U2U Group Set Up](#) on page 59 , and [Configuring U2U Network Settings](#) on page 61 .

– or –

Contact Vertiv™ Technical Support at 1-800-543-2778 or <https://www.vertiv.com/en-us/support/>.

U2U Network Requirements

The network must be private:

- Isolated from other network traffic.
- Switches connecting the units must be dedicated to Vertiv™ Liebert® iCOM™ communication only.
- Do not connect the U2U network to the building or IT network. If the U2U network experiences a failure, the cooling units continue to operate independently.

Liebert® iCOM™ supports up to 64 nodes on the U2U network. The following are considered nodes:

- Input/output board (one in each cooling unit)
- Large wall mount display

Small touchscreen displays on the cooling unit are not considered nodes because they are directly connected to the input/output board in the unit, not the network.

Of the 64 nodes, up to 32 may be cooling unit input/output boards connected as a group. **Table 13.5** below , provides U2U network configuration examples.

Table 13.5 Example Liebert® iCOM U2U Network Configurations

Configuration Example	No. of Input/Output Boards (Cooling Units)	No. of Wall Mount Displays	Private Switch Required?
A	2	0	No
B	2	1	Yes
C	3	0	Yes
D	8	1	Yes
E	32	5	Yes
F	32	32	Yes

13.5.4 Wiring Cooling Units without Wall Mount Displays

NOTE: Cooling units are factory wired for stand-alone operation. Do not connect the U2U network cabling before setting the U2U network configuration/groups. Network communication conflicts and unreliable display readings will result.

NOTE: Before you begin, refer to [Preparing for U2U Group Set Up](#) on page 59 , and [Configuring U2U Network Settings](#) on page 61 .

To connect two cooling units with a touchscreen, a network switch is not needed:

- Connect a crossover CAT5 cable to the ETH-2 connector on the rear of each display as shown in **Figure 13.16** below .

Figure 13.16 Connection between Only Two Cooling Units—No Network Switch Needed

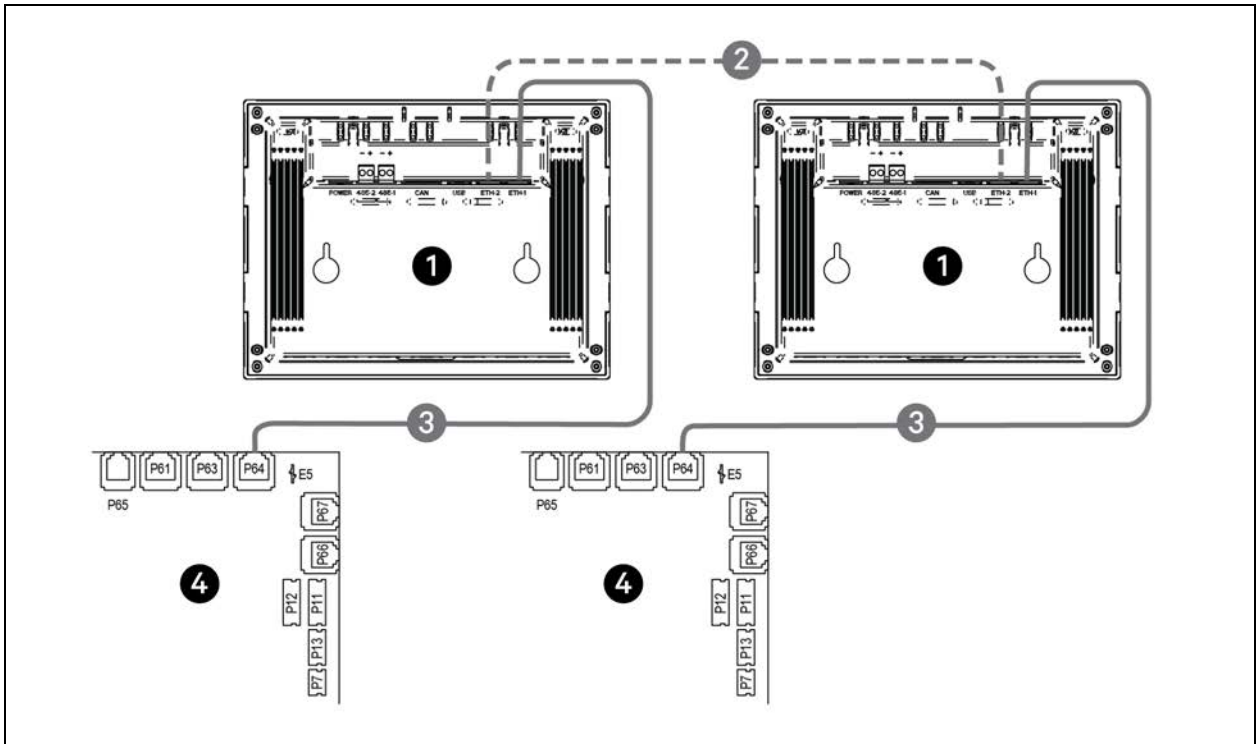

Item	Description
1	Touchscreen (rear view)
2	Ethernet cable (field-supplied)
3	Ethernet cable (factory-supplied)
4	iCOM I/O board

To connect two or more cooling units into one group (maximum 32 units per group, up to 99 groups), a network switch is required:

- On each unit, connect one plug on the CAT5 cable to ETH-2 on the rear of the display, and the other to the network switch, see **Figure 13.17** below .

Figure 13.17 Connecting Two or More Units with a Network Switch

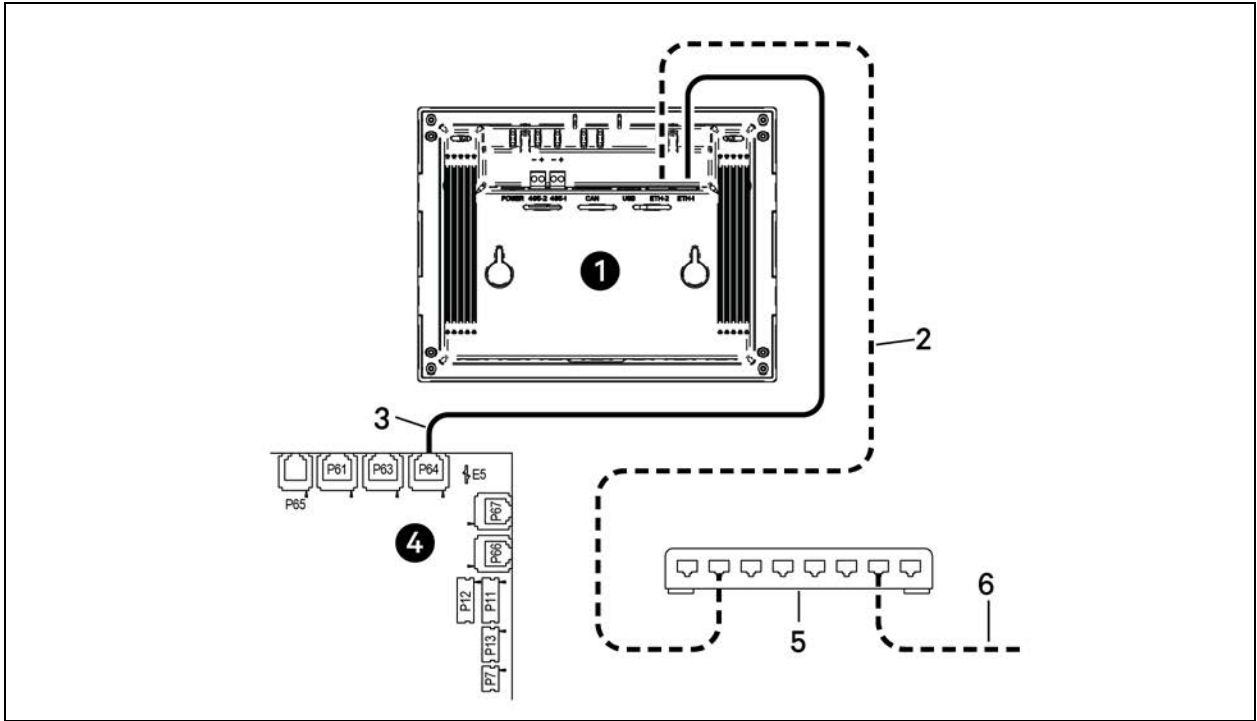

Item	Description
1	Touchscreen (rear view)
2	Ethernet cable (field supplied)
3	Ethernet cable (factory supplied)
4	iCOM I/O board
5	Network switch (field supplied)
6	to ETH-2 on rear of other cooling-unit touchscreens

13.5.5 Wiring Cooling Units with Wall Mount Displays

NOTE: Cooling units are factory wired for stand alone operation. Do not connect the U2U network cabling before setting the U2U network configuration/groups. Network communication conflicts and un-reliable display readings will result.

NOTE: Before you begin, refer to [Preparing for U2U Group Set Up](#) on page 59 , and [Configuring U2U Network Settings](#) on page 61 .

Large, wall mount displays may be used to remotely configure, control and monitor all cooling units connected on the U2U network.

- Each display requires 120 VAC or 230 VAC input power.
- An AC adapter wall plug is factory supplied.

To connect wiring:

1. On each wall mount display (32 max.), connect one plug of a straight-through Ethernet cable to port P64 on the rear of the display.
2. Connect the other end to the U2U network switch.

This page intentionally left blank

Appendices

Appendix A: Technical Support and Contacts

A.1 Technical Support/Service in the United States

Vertiv Group Corporation

24x7 dispatch of technicians for all products.

1-800-543-2378

Liebert Thermal Management Products

1-800-543-2778

Liebert Channel Products

1-800-222-5877

Liebert AC and DC Power Products

1-800-543-2378

A.2 Locations

United States

Vertiv Headquarters

1050 Dearborn Drive

Columbus, OH, 43085, USA

Europe

Via Leonardo Da Vinci 8 Zona Industriale Tognana

35028 Piove Di Sacco (PD) Italy

Asia

7/F, Dah Sing Financial Centre

3108 Gloucester Road

Wanchai, Hong Kong



This page intentionally left blank

Appendix B: Setpoints and Alarm Settings by Line ID

These tables list the parameters by the line identification assignments employed before the Vertiv™ Liebert® iCOM™ touchscreen. The tables include range/options of the parameter, the factory default setting, and a description of the parameter function.

The line IDs are not listed in the User or Settings menus, only in the parameter directory. You can search the parameter list to find the line ID and its associated label and value in the Liebert® iCOM™ user interface.

To search the parameters list:

1. Log in at the Service level, then touch  >  > Parameter Directory.
2. Enter a line ID or term in the Search field, and touch .

B.1 Line IDs for Setpoint Parameters

Table B.1 User Menu Setpoints by Line ID

Line ID	Parameter Name	Range	Default Setting	Description
U102	Temperature Setpoint Act	32 - 113 °F 0.0 - 45.0 °C	73 °F 23.0 °C	Selects the temperature that the cooling unit will maintain by applying cooling and/or reheats. Temp Set value is the temperature that has been set by the User to control the temperature. *Temp Act* value is a read-only value that indicates if another routine, such as supply compensation, has internally modified the temperature controlling value. If compensation has not be activated, the ACT and SET values will always match.
	Temperature Setpoint	41 - 104 °F 5.0 - 40.0 °C	73 °F 23.0 °C	
	TempSetUsr	41 - 104 °F 5.0 - 40.0 °C	73 °F 23.0 °C	
U103	Temperature Control Sensor	Supply Sensor Remote Sensor Return Sensor	Return Sensor	Selects the sensor that will control the cooling capacity; either chilled water valve, compressors, free cooling valve, or air economizer. Unloading-type compressors can be set to any type of sensor, however, fixed-style compressors can only be set to Return or Remote sensors.
U104	Humidity Dew Point Setpoint	41 - 65 °F 5.0 - 18.3 °C	48°F 8.9 °C	Selects a humidity level that the cooling unit will maintain by removing or adding moisture to the air. The humidity setpoint will be represented in %RH or Dew Point value depending on what the humidity control type is set for.
	Humidity Setpoint	20 - 80 %RH	50 %RH	
U105	Humidity Control Sensor	Remote Sensor Return Sensor	Return Sensor	Defines which humidity value the setpoint will be compared with. The return sensor is equipped with Temp/Humidity sensor and can calculate the dew point based on Liebert® iCOM's internal lookup table. If a sensor other than the return sensor is selected, the iCOM will calculate the correct %RH based on the sensor selected and its actual temperature reading.
U106	Humidity Control Type	Relative Compensated Predictive Dew Point	Predictive	Selects the humidity control calculation. If set to *Relative*, the unit will control the humidity without considering any temperature deviations. If set to *Predictive* and *Absolute*, the control will consider the temperature deviation from temperature setpoint so that a constant level of moisture is kept in the area based on the humidity sensor reading and the temperature deviation from setpoint. *Dew Point* allows the Liebert® iCOM™ controller to calculate the actual dew point of the space and to control the humidity based on a user- entered dew point temperature.

Table B.1 User Menu Setpoints by Line ID (continued)

Line ID	Parameter Name	Range	Default Setting	Description
U107	Fan Setpoint	41 - 104 °F 5.0 - 40.0 °C	73 °F 22.8 °C	Required anytime the fan operates from a different sensor than that used for the temperature setpoint. EX: temperature setpoint is set to Supply Air and the fan control is set to Remote Air. This is considered "Optimized Aisle" control, which decouples the fan and cooling capacity modulation. The remote sensor setpoint would modulate the fan speed and the supply sensor setpoint would modulate the cooling.
U108	Fan Control Sensor	Supply Sensor Remote Sensor Return Sensor Manual	Disabled	Determines which sensor will control the speed of the fan. If set to "Manual", then the fan control can be set through the local Vertiv™ Liebert® iCOM™ display or through the BMS system via one of the various Intellislot monitoring cards.
U110	Optimized Aisle Enabled	Disabled Enabled	Disabled	This read-only value indicates if the Liebert® iCOM™ controller is setup in a Optimized Aisle configuration. To enable optimized aisle via the Liebert® iCOM™ display, the Supply Air sensor must be set to control the cooling capacity and the remote sensor must be set to control the fan speed. This allows the cooling unit to maintain rack temperatures while still maintaining an even under-floor air temperature when controlling unbalanced rooms.
U113	2nd Temperature Setpoint	41 - 104 °F 5.0 - 40.0 °C	73 °F 23.0 °C	Allows for a dry contact through the customer input connections. When a customer input connection is set for 2nd temperature setpoint and that input is triggered, then the value set in this parameter sets the active temperature setpoint the unit will maintain. If the unit is configured for De-coupled Mode, then this setpoint will only affect the temperature control setpoint; it will not affect the fan control setpoint.
U114	Supply Temp Limit Setpoint	41 - 81 °F 5.0 - 27.0 °C	41 °F 5.0 °C	Selects the minimum discharge air temperature. When the actual sensor reading approaches this parameter, the cooling capacity will be limited to avoid going below the Supply Limit Temperature value. This parameter must be enabled in the Service Menu/Setpoints menu prior to setting a supply limit setpoint.
U116	BMS Backup Temp Setpoint	41 - 104 °F 5.0 - 40.0 °C	73 °F 23.0 °C	Selects a temperature setpoint that will be activated in the event of a BMS time-out or a customer input signal. The BMS timer and/or the customer input must be configured for this parameter to activate. If the unit is operating in De-coupled mode, then this setpoint will only affect the temperature control setpoint; it will not affect the fan control setpoint.
U117	BMS Backup Fan Setpoint	41 - 104 °F 5.0 - 40.0 °C	73 °F 23.0 °C	Selects a temperature setpoint when the backup fans will be activated in the event of a BMS time-out or a customer input signal. The BMS timer and/or customer input must be configured in order for this parameter to activate. If the unit is operating in De-coupled mode, then this setpoint will only affect the temperature control setpoint; it will not affect the fan control setpoint.
	BMS Backup Fan Speed	0 - 100 %	100%	
U119	Return Compensation Setpoint	41 - 104 °F 5.0 - 40.0 °C	73 °F 23.0 °C	Allows the return air sensor to be used even when in Supply or Remote temperature control mode. Return Compensation modifies the temperature setpoint to ensure that the return air temperature is kept above a specific temperature. If the return compensation value is set to 80 °F and the actual return temperature falls to 75 °F, then the controlling temperature setpoint will be increased and will reflect in the "Control Temp Act" parameter.

Table B.2 Service Menu Setpoints by Line ID

Line ID	Parameter Name	Range	Default Setting	Description
S102	Temperature Control Sensor	Supply Sensor Return Sensor Remote Sensor	Return Sensor	Selects which sensor will be controlling/influencing the cooling capacity. Cooling Capacity is either the Chilled Water Valve, Compressor, Free Cooling Valve, or Air Economizer. Unloading type compressors can be set to any sensor type, however fixed style compressors can only be set to Return or Remote control sensor.
S103	Temperature Setpoint	41 - 104 °F 5.0 - 40.0 °C	73 °F 23.0 °C	Selects a temperature that the cooling unit will maintain by applying cooling and/or reheats. The temperature setpoint value that has been set by the User to control the temperature.
	Temperature Setpoint Actual	32 - 113 °F 0.0 - 45.0 °C	73 °F 23.0 °C	The temperature setpoint actual value is a read-only value that indicates if another routine, such as supply compensation has internally modified the Temperature controlling value. If compensation has not been activated, the ACT and SET will always match.
S104	Temperature Control Type	Proportional PI Adaptive PID Intelligent	PI	Sets the type of control to be followed: Proportional, PI, Adaptive PID (auto-tuning), Intelligent
S105	Temperature User Low Limit	41 - 104 °F 5.0 - 40.0 °C	41 °F 5.0 °C	Defines the temperature range below setpoint; temperature setpoint cannot be adjusted below this value. If the setpoint value has been adjusted lower than this setting, then the setpoint will automatically default back to its previous setting.
	Temperature User High Limit	41 - 104 °F 5.0 - 40.0 °C	104 °F 40.0 °C	Defines the temperature range above setpoint; temperature setpoint cannot be adjusted above this value. If the setpoint value has been set higher than this setting, then the setpoint will automatically default back to its previous setting.
S106	Temperature Proportional Band	4 - 200 °F 2.2 - 111.0 K	12 °F 6.7 K	Adjusts the activation points of compressors/chilled water valves or rate of changed based on the actual sensor values deviation from setpoint. The smaller this number, the faster the compressors/chilled water values will increase capacity. Too small of a number may cause the unit to short cycle compressors or excessively reposition the valve.
	Temperature Integral Time	0.0 - 15.0 min	5.0 min	Adjusts the capacity of the units based on time away from setpoint so that accurate temperature control can be maintained. The proportional and integral time settings work together to maintain setpoint. Large p-band and small integral time is typical when controlling to supply air.
S107	Temperature Derivative Time	0 - 900 sec	0 sec	
S108	AutoSet Enable	No Yes	Yes	Sets the temperature and humidity proportional bands automatically based on the type of unit when this parameter is set to YES and if teamwork modes are selected. To change the proportional bands, this parameter must be set to "NO". If supply or remote sensors are used, then this value is always set to NO.
S109	Temperature Deadband	0 - 36 °F 0 - 20.0 K	2 °F 1.1 K	Avoids overshooting of the setpoint and cycling between cooling and reheats. The value entered in this field will be split in half by the temperature setpoint.
S110	Supply Limit Enabled	No Yes	No	Chilled water units may be set up with the supply air sensor to maintain a minimum air temperature under the raised floor to help prevent condensation. In order to avoid supply temperatures that are too low, the Supply Limit can influence the opening of three point or analog actuators or the output of analog values. The control compares the deviation from the return air setpoint & the supply limit setpoint, and calculates the output to the actuator from the smaller deviation.
	Supply Limit Setpoint	41 - 81 °F 5.0 - 27.0 °C	41 °F 5.0 °C	
S111	Heater Deadband	0 - 36 °F 0 - 20.0 K	0 °F 0.0 K	Changes the amount of deviation below the temperature setpoint that the heaters will cycle ON and OFF. This value is added to the heating side of the normal temperature deadband.

Table B.2 Service Menu Setpoints by Line ID (continued)

Line ID	Parameter Name	Range	Default Setting	Description
S113	Enable Temperature Compensation	No Return Supply Ret+Sup	No	Temperature compensation allows for a second or even a third sensor to be used that will influence the units cooling or heating. Return compensation can be used when the supply or remote sensors are being used for control. Then the return sensor is then monitored to maintain a minimum return temperature. Supply compensation can be used only when Optimized Aisle (TW3) is enabled. The supply sensor will not only be used for controlling cooling capacity but will also monitor the cold aisle temperature to ensure that the cold aisle temperature setpoint is met.
S114	Return Compensation Setpoint	41 - 104 °F 5.0 - 40.0 °C	73 °F 23.0 °C	The temperature setpoint where compensation begins to operate by increasing the supply air setpoint.
S115	Return Compensation Band	0 - 18 °F 0.0 - 10.0 K	0 °F 0.0 K	The return compensation band/value will determine how quickly the cooling capacity is adjusted as the return temperature drops below the return compensation setpoint.
	Return Compensation Value	0 - 18 °F 0.0 - 10.0 K	0 °F 0.0 K	
S116	Supply Compensation Value	0 - 18 °F 0.0 - 10.0 K	0 °F 0.0 K	The Supply Compensation value determines how much the supply temperature setpoint will be reduced when the units fan speed is at 100% and the cold aisle is not able to maintain temperature setpoint. Any modifications to the supply temperature setpoint will be shown at the temperature setpoint on parameter S103 as the actual active control point.
S118	Compressor Capacity Filter at 0 %	0.01 - 99.99 %/s	0.60 %/s	Controls the rate of change during compressor load changes to avoid overshoots. The filter value depends on the current control deviation from setpoint. On the setpoints (@ 0% call for cooling), it's typically set lower (slow).
	Compressor Capacity Filter at 100%	0.01 - 99.99 %/s	4.00 %/s	At the end of the proportional band (@ 100% call for cooling) it's typically set higher (faster).
S119	Capacity Transition Filter	0.01 - 99.99 %/s	4.00 %/s	This parameter should only be adjusted by a factory-service trained technician. The transition capacity filter controls how quickly the capacity changes between different modes of operation. This filter helps with the transition to avoid overshoot.
S120	CW Capacity Filter @ 0%	0.01 - 99.99 %/s	0.10 %/s	The CW capacity filter controls the rate of change during a valve position adjustment to avoid overshoots. The filter value depends on the current control deviation from setpoint. On the setpoint (@ 0% call for cooling), its typically set lower (slower)
S121	CW Capacity Filter @ 100%	0.01 - 99.99 %/s	0.60 %/s	At the end of the p-band (@ 100% call for cooling) its typically set higher (faster)
	BMS Backup Temp Setpoint	41 - 104 °F 5.0 - 40.0 °C	73 °F 23.0 °C	Selects a temperature setpoint that will be activated in the event of a BMS timeout. The BMS timer must be configured for this parameter to be active.
S122	2nd Temperature Setpoint	41 - 104 °F 5.0 - 40.0 °C	73 °F 23.0 °C	Selects a temperature setpoint that will be activated in the event of a customer input signal configured as the second setpoint. The customer input must be configured for the parameter to activate.
S124	Humidity Control Sensor	Remote Sensor Return Sensor	Return Sensor	Defines which humidity sensor the humidity setpoint is compared with. The return sensor is equipped with a Temp/Hum sensor and can calculate the dew point

Table B.2 Service Menu Setpoints by Line ID (continued)

Line ID	Parameter Name	Range	Default Setting	Description
				based on Vertiv™ Liebert® iCOM™'s internal lookup table. If a sensor other than the return sensor is selected, the Liebert® iCOM™ will calculate the corresponding RH% based on that sensors actual temperature.
S125	Dew Point Setpoint	41 - 65 °F 5.0 - 18.3 °C	48 °F 8.9 °C	Selects a humidity level that the cooling unit will maintain by removing or adding moisture to the air. The humidity setpoint will either be set in percent RH or as a Dew Point value depending on what the humidity control type is set for.
	Humidity Setpoint	20 - 80 %	0.5	
S126	Humidity Control Type	Relative Compensated Predictive Dew Point	Predictive	Selects the humidity control calculation. Setting this parameter to Relative (%RH) will control the humidity without considering any temperature deviations. Predictive and Absolute control consider the temperature deviation from temperature setpoint so that a constant level of moisture is kept in the area based on the humidity sensor reading and the temperature deviation from setpoint. Compensated is recalculated with the actual deviation from temperature setpoint. 1 degree Celsius is equal to 3 %RH, indirect proportional. If temperature increases, the humidity setpoint is decreased and vice versa.
	Humidity Control Mode	Supply Return	Return	
S127	Dew Point Proportional Band	2 - 18 °F 1.1 - 10.0 K	8 °F 4.4 K	Adjusts the activation points of the humidifier and compressors based on the actual sensor values deviation from setpoint. The smaller this number, the faster the compressors and humidifier will increase capacity. Too small of a number may cause the unit to short cycle or overshoot setpoint.
	Humidity Proportional Band	1 - 20%	0.2	
S128	Humidity Integration Time	0.0 - 25.0 min	0.0 min	Adjusts the capacity of the unit based on a time away from setpoint so that accurate humidity control can be maintained. If the integration time is set to 0, the humidity control operates as a "proportional only" control. When integration time is set, the control mode changes to "PI" control
S129	Humidity Deadband	0 - 18 °F 0.0 - 10.0 K	4 °F 2.2 K	Prevents overshooting of the setpoint and cycling between humidification and dehumidification. The value entered in this field will be split in half by the temperature setpoint.
S130	Dehum Supply Temperature Setpoint	41 - 104 °F 5.0 - 40.0 °C	54 °F 12.2 °C	Allows for a target temperature setpoint to be activated when a call for dehumidification is enabled instead of the traditional method of over cooling the space by increasing cooling to 100% and lowering fan speed if equipped. Must be in supply air control mode. When a call for dehumidification is active, the supply or remote sensor setpoint will be lowered to this parameter. This parameter should be set below the accepted dew point threshold of your space. Used only when supply dehumidification is enabled.
	Actual Dehum Temperature Setpoint	41 - 104 °F 5.0 - 40.0 °C	50 °F 10.0 °C	
S131	Dehum Setpoint Adjustment	0 - 18 °F 0.0 - 10.0 K	9 °F 5.0 K	Sets the amount of that the Dehum Temp Setpoint is adjusted once the reheats activate. EX: If the unit is equipped with a reheat device, this parameter will increase the dehumidification temperature as the call for reheats are increased until the reheat call is at 100%. When the reheats are at 100%, the full Dehum Setpoint Adjustment will be applied.
	Dehum Setpoint Filter	0.01 - 0.10 K/s	0.02 K/s	
S132	Dehum Reheat/LL Sensor	Supply Sensor Remote Sensor Return Sensor	Return Sensor	Sets the sensor and temperature start point that the reheat will be deactivated and dehumidification will be stopped due to over cooling the space in a call for dehumidification.
	Dehum Reheat/LL Setpoint	41 - 104°F 5.0 - 40.0 °C	71 °F 21.7 °C	
S133	Dehum/Reheat Low Limit 1 Temp	-30.0 °F - -2.0°F	-5 °F	Dehum/Reheat Low Limit 1

Table B.2 Service Menu Setpoints by Line ID (continued)

Line ID	Parameter Name	Range	Default Setting	Description
	Hysteresis	-16.7K - -1.1K	-2.5 K	
	Dehum/Reheat Low Limit 2 Temp Hysteresis	-30.0 °F - -2.0°F -16.7K - -1.1K	-7 °F -3.9 K	Dehum/Reheat Low Limit 2
S13A	Dehum Reheat Proportional Band	2 - 54 °F 2.0 - 30.0 K	14 °F 7.8 K	Sets the reheat proportional band for reheat operation independently of the temperature proportional band. This parameter can be used to activate the reheats at different points below the temperature setpoint.
S13B	Estimated Aisle Temp	41 - 104 °F 5.0 - 40.0 °C	75 °F 23.9 °C	Sets an estimated cold aisle temperature when humidity control sensor is set to remote and no remote temperature sensors are installed at the unit. This estimated temperature will be used to determine the humidity versus using an actual temperature in the cold aisle that may fluctuate during modes of dehumidification or load changes of the IT equipment. This provides a stable control point to reference the actual measured dew point from the return sensor.
S135	DT1 (Room/Outdoor) Type	0 = Disabled 1 = Contact 2 = EFC 3 = Temp 4 = Set	Temp	Sets the activation point of the ambient dry bulb outdoor temperature as it relates to either an indoor actual temperature or temperature setpoint.
S136	DT1 (Room/Outdoor) Value	2 - 72 °F 1.0 - 40.0 K	5 °F 3.0 K	Field-adjustable setpoint or temperature
S137	DT2 (Room/FC Fluid) Type	Disabled Contact Temp Set	Disabled	Determines the method to activate the water circuit on Dual-Cool and Free-Cool units. It may be set to CONTACT, TEMP or SET. CONTACT uses a dry contact to activate the free-cooling circuit. TEMP uses a sensor reading that can be compared to the return temp to see whether free-cooling is possible. SET compares the temperature set to the free-cooling sensor to determine free-cooling availability.
S138	DT2 (Room/FC Fluid) Value	0 - 36 °F 0.0 - 20.0 K	12 °F 6.7K	sets the delta T between the actual temperature and fluid temperature that must be met before free-cooling will occur.
S139	Minimum Chilled Water Temp Enable	No Yes	Disabled	Enables the temperature at which free-cooling can operate independently without assistance of the compressor circuit(s).
S140	Minimum Chilled Water Temp Value	32 - 68 °F 0.0 - 20.0 °C	45 °F 7.0 °C	Sets the water temperature at which 100% free cooling can be provided to handle the full room load. When the fluid temperature is below this setting, then the compressors will no longer turn ON until the water temperature is above the minimum CW temperature.
S141	Lockout FC at Fluid Below	6 - 50 °F -15.0 - +10.0°C	32 °F 0.0 °C	Prevents frost from building up on the free cooling pipes when the outdoor ambient temperature is extremely low by turning OFF the free-cooling circuit when the water temperature is too low.
S146	Fan Control Sensor	Supply Sensor Remote Sensor Return Sensor Manual	Return Sensor	Controls the fan speed for modulation. If MANUAL is selected, then the fan speed can be controlled from the local display or through a building management system.
S147	Fan Setpoint	41 - 104 °F	73 °F	Activated when a temperature sensor is being used to control the fan speed. If the

Table B.2 Service Menu Setpoints by Line ID (continued)

Line ID	Parameter Name	Range	Default Setting	Description
		5.0 - 40.0 °C	22.8 °C	same sensor is used for temperature control and fan speed control, then this value will reflect the same setpoint as the temperature control setpoint. Manual mode uses fan speed STD for control.
S148	Fan Temperature Control Type	Proportional PI Adaptive PID	PI	Sets the type of control the unit will use to control fan speed. PI control gain is set in the Temp Prop/Integral parameter. PI control will operate the fan speed so that the actual temperature of the fan control sensor is equal to the fan temp setpoint. If PROPORTIONAL only is selected, the fan will change "ONLY" based on the deviation from setpoint which will allow the actual temp to settle higher than setpoint.
149	Fan Temperature Control Prop Band	4 - 200 °F 2.0 - 111.0 K	36 °F 20.0 K	Adjusts the fan speed rate of change based on the actual sensor values deviation from setpoint. The smaller this number, the faster the fans will increase speed. Too small of a number may cause the fans increase/decrease to overshoot setpoint
	Fan Temperature Control Integration Time	0.0 - 15.0 min	1.0 min	Adjusts the fans of the unit based on time away from setpoint so that accurate temperature control can be maintained. The proportional and integral work together to maintain setpoint. Large p-band with small integral time is a typical way to achieve stable control.
S150	Fan CFF Hysteresis	0 - 20 %	0.02	Modifies the reaction of the fan speed when fan speed is being dictated by the Call for Cooling. Adding the Hysteresis may result in a lagged response to changes in fan speed.
	Fan Deadband	0 - 36 °F 0 - 20.0 K	1 °F 0.6 K	Avoids overshooting of the setpoint. The value entered in this field will be split in half by the fan speed setpoint
S151	Airflow Calibration	3.0 - 10.0 V	10.0 V	Allows the front display to be scaled to show the actual percentage of airflow independent of the voltage operating the fan speed. This value cannot be set above/below the Analog Output High/Low Limit for the fan set in the Advanced Menu. This also includes the service menu fan speed parameters.
S152	Fanspeed VSD Setpoint Minimum	0 - 100 %	0.7	Sets the range for the variable fans. Min sets the minimum speed that the fan will operate at. Fan speed is modulated between MIN and STD based on which sensor is set as the controlling sensor, setpoint and the PI settings. If the controlling sensor is set to manual, then the STD setting will control the current fan speed. This parameter is also adjustable through the BMS.
	Fanspeed VSD Setpoint Standard	0 - 100 %	1	
S153	Fanspeed VSD Setpoint Dehum	0 - 100 %	70%	Sets the fan speed when a call for dehumidification is active. This allows the units fan speed to be ramped lower to help with any overcooling due to the dehumidification process. This also allows the coil to remove additional moisture even faster
	Fanspeed VSD Setpoint No Power	0 - 100 %	100%	
S154	Allow Fan Modulation on Compressors	No Yes	Yes	Provides the option to set the fan to fixed speed if unit is equipped with compressors. Once this parameter is set at the local display, it must be removed at the local display to re-engage fan speed control.
S155	High Return Limit Enable	Disabled Local Team	No	Sets a control point that will increase the fan speed if the return temperature exceeds the limit set in the High Return Temperature Limit parameter. If set to DISABLED, no limit will be applied to the return air temperature. If set to LOCAL, then only the local units return temperature will be monitored for applying the limit. If set to TEAM, then the highest networked unit return temperature will activate the limit on all connected units.
S15A	High Return Temperature Limit	41 - 104 °F 5.0 - 40.0 °C	85 °F 29.4 °C	Sets the temperature limit that will increase the fan speed to decrease the return temperature. Some compressors may require this limit to prevent extremely high temperatures that could potentially cause degradation of the compressor oil, that

Table B.2 Service Menu Setpoints by Line ID (continued)

Line ID	Parameter Name	Range	Default Setting	Description
				could decrease the overall compressor life expectancy.
S15B	Return Limit Proportional Band	0 - 36 °F 0.2 - 20.0 K	20 °F 11.1 K	Sets the rate of fan speed increase as the actual return temperature approaches the limit set in the High Return Temperature limit parameter.
S157	Fan Startup Time	0 - 600 sec	3 sec	Determines the speed of the fan at system start-up. The fan will operate at the set speed (%) until the set time has elapsed; at this point the fan will assume normal operation.
	Fan Startup Speed	0 - 100 %	100%	
S158	Fanspeed Filter @ 0%	0.01 - 99.99 %/s	0.20 %/s	This parameter should only be adjusted by factory service trained technician. Fan Cap Filter at 0/100% controls the rate of change during fan speed changes to avoid overshoots. The filter value depends on the current control deviation from setpoint. On the setpoint (at 0%), its typically set lower (slower). At the end of the p-band (at 100%) its typically set higher (faster). The value is given as a % control output per second change. This parameter sets the rate of changed based on where actual temperature is when compared to setpoint.
S159	Fanspeed Filter at 100%	0.01 - 99.99 %/s	1.00 %/s	This parameter should only be adjusted by factory service trained technician. The transition fan speed filter controls how quickly the fan speed changes between different modes of operation. This filter helps with the transition to avoid overshoots.
	Fanspeed Transition Filter	0.50 - 99.99 %/s	1.00 %/s	
S160	Fanspeed Reposition Mode	Decel Both	Decel	This parameter should only be adjusted by factory service trained technician. The fan speed reposition mode/delay is a one time delay as the fan speed is requested to change direction. This delay will be applied only when the fan speed is commanded from an increasing to decreasing state or decreasing to increasing state. This allows the fan to hold its current position while the temperature stabilizes.
	Fanspeed Reposition Delay	0 - 300 sec	0 sec	
S161	Max Deceleration Rate	0.01 - 99.99 %/s	0.10 %/s	This parameter should only be adjusted by the factory service trained technician. Only slows the decreasing of the variable fan speed. The control will use the slower of this parameter and the fan speed filter.
S162	BMS Backup Fan Setpoint	41 - 104 °F 5.0 - 40.0 °C	73 °F 23.0 °C	Selects a fan speed setpoint that will be activated in the event of a BMS Timeout. The BMS timer must be configured for this parameter to activate.
	BMS Backup Fanspeed	0 - 100 %	1	
S163	BMS Backup Fan Operation	Disabled BMS Backup Spd Coupled BMS Backup Set	Disabled	Sets the default operation of the fan speed control when a BMS Timeout occurs. Default is disabled which will keep the fan speed at the last value before the disconnect occurred. STD speed will ramp the fan to the STD speed setting. This will drive the fan speed to its maximum speed. The control will use the slower value. COUPLED will set the fan speed to follow the cooling capacity. BACKUP SET will use the BMS Backup Setpoint to drive fan speed.
S164	Allow BMS to change Fanspeed	No Yes	Yes	Enables or disables BMS fan speed control. When this parameter is disabled, the BMS will not have write capability to this point.
S165	BMS is connected to	Velocity Ana In 1 Ana In 2 Ana In 3 Ana In 4	Velocity	If the BMS is connected to Analog Input (1-4), it is used for manually writing to & controlling the unit fan speed using a low-voltage control signal. If the BMS is set to 'Velocity' (V3 or V4), it is used for manually writing to & controlling the unit fan speed via the Velocity protocol.

Table B.2 Service Menu Setpoints by Line ID (continued)

Line ID	Parameter Name	Range	Default Setting	Description
	BMS Analog Input Signal Type	0-5V 0-10V 4-20mA None	None	
	BMS Analog Input current value	0 - 100%	100%	
S166	High Temp Limit Approach	Disabled Supply Return	Return	Sets the sensor to be used to increase the fan speed value above the fans peed setpoint STD to the value set in the Analog Output high limit.
S16A	High Temp Limit Approach at	0 °F / +10 °F 0 K / +5.5 K	2 °F 1.1 K	Sets the temperature differential below the high supply and high return temperature limit where the fan speed would increase from fan speed setpoint STD to fan speed MAX.
S16B	FC / AirEco Ramp Up w/ CFC	0 = No 1 = Yes	0 (No)	Sets the selection to decouple the fan output from the call for cooling.
S168	Fan Back Draft Control	Disabled Enabled	Disabled	Enables/disables Fan Back Draft Control. This feature allows EC Fans (only) to operate at very low speeds to prevent airflow from cycling through the unit due to a high under-floor static pressure than above the floor static pressure. VFD's cannot be used with this feature due to motor and/or bearing degradation that may occur at the low fan speeds required to support this feature.
S169	VSD Setpoint Back Draft	0.1 - 5.1 V	1.5 V	The variable speed device setpoint is set as a voltage reference. The lower the voltage, the slower the fans will spin. This parameter is set based on the application. Higher under-floor static pressure may require a higher setting to prevent airflow through the unit.
S171	Not Selectable Zone 1 Low	0.0 - 5.0 V	3.5 V	The not selectable zone 1 and 2 are zones that the EC fans cannot operate within due to vibration harmonics that the fans may introduce to the unit. These parameters will be set from the factory based on model type and should not need adjusted in the field.
S172	Not Selectable Zone 2 Low Not Selectable Zone 2 High	0.0 - 5.0 V 0.0 - 5.0 V	0 V 0 V	The not selectable zone 1 and 2 are zones that the EC fans cannot operate within due to vibration harmonics that the fans may introduce to the unit. These parameters will be set from the factory based on model type and should not need adjusted in the field.
S173	Stop BDR when System is OFF	No Yes	No	The above is true when S173 Stop BDR when System is OFF is set to "YES". If set to "NO", the BDR mode will not be interrupted, unless BDR is disabled or the unit is restarted.
S175	Display Off and BDR	Off BackDraft	Off	When the back draft damper is enabled, different modes can activate this feature. Remote Off, Display Off, BMS Off, and Local Off can all be set to activate the back draft damper operation. This is done by pressing the ON/OFF key at the unit to put the unit in a Display Off condition
S176	BMS Off and BDR	Off BackDraft	Off	When the back draft damper is enabled, different modes can activate this feature. Remote Off, Display Off, BMS Off, and Local Off can all be set to activate the back draft damper operation. This is done by sending a remote OFF signal from BMS to the unit to be remotely OFF.
S177	LOC Off and BDR	Off BackDraft	Off	When the back draft damper is enabled, different modes can activate this feature. Remote Off, Display Off, BMS Off, and Local Off can all be set to activate the back draft damper operation. This is done by sending local OFF signal to the unit by pressing the ON/OFF key.

Table B.2 Service Menu Setpoints by Line ID (continued)

Line ID	Parameter Name	Range	Default Setting	Description
S179	SCR Control Type	None Tight Standard	None	Sets the control type for the SCR reheats. If set to Standard, then the reheats will modulate when the temperature is below setpoint based on the control settings. If set to Tight, then one compressor will be locked on and the reheats will modulate to offset the cooling capacity.
S180	Start 1st Compressor at	-100 / +100 %	0%	Sets activation point of the first compressor. This parameter can be used when set to "Tight" control with SCR.
S181	Stop 1st Compressor at	-200 / +50 %	-200 %	Sets the deactivation point of the first compressor. This parameter can be used when set to "Tight" control with SCR.
S182	1st Compressor stop delay	0 - 30 min	20 min	Sets the delay when the stop compressor setpoint for the first compressor is met.
S183	Start 2nd Compressor at	-100 / +100 %	100%	Sets activation point of the second compressor. This parameter can be used when set to "Tight" control with SCR.
S184	Stop 2nd Compressor at	-200 / +50 %	0%	Sets the deactivation point of the second compressor. This parameter can be used when set to Tight control with SCR.
S185	2nd Compressor stop delay	0 - 30 min	0 min	Sets the delay when the stop compressor setpoint for the second compressor is met.
S186	Cycle Time	1.0 - 200.0 sec	1.0 sec	Set at the factory and should be changed only by an authorized Vertiv/Liebert technician.
S187	SCR Factor	1.0 - 10.0	1	Set at the factory and should be changed only by an authorized Vertiv/Liebert technician.
S188	Actual SCR request	0 - 100 %	0%	Displays the actual SCR reheat being requested.
S190	Static Pressure Fan Control	Disabled Limit Control	Disabled	Enables/disables the use of static pressure control for fan modulation.
S191	Static Pressure Setpoint inWC	0.010 - 1.003 inWC	0.020 inWC	Sets the static pressure setpoint to be used by the control to modulate the fan control.
	Static Pressure Setpoint Pa	2 - 250 Pa	5 Pa	
S192	Static Pressure Deadband in WC	0.010 - 1.003 inWC	0.020 inWC	Sets the static pressure deadband.
	Static Pressure Deadband Pa	2 - 250 Pa	5 Pa	
S193	SP Pause Time at deadband minimum	0 (Disabled) - 180 sec	30 sec	Sets the minimum and maximum pause times when the static pressure crosses into the deadband border. The fan speed will stop increasing or decreasing based on the time set in these parameters.
	SP Pause time at deadband maximum	2 - 180 sec	60 sec%	
S194	SP Pulse Time inside Deadband	2 - 15 sec	3 sec	Sets the pulse time that the speed filter will be performed to the fan analog output.
S195	Static Pressure Prop Band inWC	0.010 - 1.003 inWC	0.020 inWC	Sets the proportional band for which the fan speed modulation output calculation is based upon in relation to the difference between the pressure reading the SP Setpoint.

Table B.2 Service Menu Setpoints by Line ID (continued)

Line ID	Parameter Name	Range	Default Setting	Description
S196	Static Pressure Prop Band Pa	2 - 250 Pa	5 Pa	Sets the use of static pressure control if dehumidification becomes active. If set to Disabled then the static pressure routines will become inactive and the fan will be allowed to ramp to the dehumidification speed set in Fan speed Dehum/No Power. If set to "Enabled", then the static pressure routines shall remain active during the call for dehumidification.
	SP During Dehum	Disabled Enabled	Disabled	
S197	Static Pressure Teamwork Mode	Average Minimum	Average	There are modes available for static pressure teamwork functionality: Average & Minimum. When selecting "Average Mode", the average of the lowest static pressure sensor readings in the system will be average to generate a shared static pressure value for all units in the team. The number of static pressure sensors to be averaged is set in line S198 SP Sensors in Avg for TW. When this line is set to a value lower than the number of units in the team, the lowest static pressure readings will be averaged.
S198	SP Sensors in Avg for TW	1 - 32	2	Sets the number of sensors used when averaging sensors in the teamwork.
S199	Operation on Sensor Failure	SP Off Freeze Speed	SP Off	This parameter determines what action to take if the static pressure sensor fails (non-teamwork). If "SP OFF" is selected, then the control will use S146 "Fan Control Sensor" to control the fan when the sensor is lost. If "Freeze Speed" is selected, then the control will keep the fan speed in its last known position. Situations that need to override the fan speed such as Freeze Protection can still change the fan speed.
S1A1	Static Pressure Upper Range inWC	0.010 - 1.003 inWC	0.030 inWC	The control calculates the Upper Range by using S191 "SP Setpoint" and S192 "SP Deadband", the results on lines show both values, inWC and Pa.
	Static Pressure Upper Range Pa	2.5 - 250.0 Pa	7.5 Pa	
S1A2	Static Pressure Lower Range inWC	0.000 - 0.993 inWC	0.010 inWC	The control calculates the Lower Range by using S191 "SP Setpoint" and S192 "SP Deadband", the results on lines show both values, inWC and Pa.
	Static Pressure Lower Range Pa	0.0 - 247.5 Pa	2.5 Pa	
S1A4	Enable Static Pressure Control Override	None Remote Sensor Return Sensor	None	
S1A5	SP Requested Speed up to	41 - 104 °F	86 °F	
		5.0 - 40.0 °C	30.0 °C	
S1A6	STD Speed at	41 - 104 °F	95 °F	
		5.0 - 40.0 °C	35.0 °C	
S1A7	Override Integration Time	0.0 - 15.0 min	0.0 min	
S1A8	Control Slew Rate Filter	0.50 - 99.99 %/s	1.00 %/s	
S1A9	Current Override Temperature	°F	invalid	
		°C		
S1B1	Current Override Value	0 - 100 %	0%	

Table B.2 Service Menu Setpoints by Line ID (continued)

Line ID	Parameter Name	Range	Default Setting	Description
S1B9	Create SuperSaver Signal	0 = No 1 = Local 2 = U2U Group AVG 3 = U2U Group MAX 4 = U2U Group MIN	0 (No)	
S1C1	Deadband Low Value	5 - 95 %	20%	
S1C2	Deadband High Value	10 - 100 %	90%	
S1C3	Update SuperSaver Signal every	30 - 300 sec	120 sec	
S1C4	Update SuperSaver Signal by	1 - 10 %	1%	
S1C5	SuperSaver Max Limit	0 - 100 %	100%	
S1C6	Current SuperSaver Request	0 - 100 %	0%	
	Current SuperSaver Signal	0 - 100 %	0%	
S1C7	U2U Aggregated Signal	0 - 100 %	0%	
XDU.006	Calibration Leaving Air Temperature	+/-18°F	0°F	Calibrate Supply Air Leaving Temperature sensor reading
XDU.008	Calibration Entering Fluid Temperature	+/-18°F	0°F	Calibrate Entering Fluid Temperature sensor reading
XDU.007	Calibration Leaving Fluid Temperature	+/-18°F	0°F	Calibrate Leaving Fluid Temperature sensor reading
XDU.009	Fluid Flow Rate at Full Scale (20mA)	10 - 1000 l/m	115 l/m	Fluid Flow Rate at Full Scale (20mA)
XDU.010	Fluid Flow Rate Setpoint	5.0 - 1000.0 l/m	50.0 l/m	display readout showing current Fluid Flow Rate
XDU.011	Fluid Pump Initial Speed	30 - 100%	50 %	Fluid Pump Initial Speed %
XDU.012	Fluid Flow Proportional Band	1.0 - 1000 l/m	20.0 l/m	Fluid Flow Proportional Band
XDU.013	Fluid Flow	0.0 - 100.0 l/m	10.0 l/m	Fluid Flow Deadband

Table B.2 Service Menu Setpoints by Line ID (continued)

Line ID	Parameter Name	Range	Default Setting	Description
	Deadband			
XDU.014	Fluid Flow Integration Time	0 - 300 sec	60 sec	Fluid Flow Integration Time
XDU.018	Pump Transition Duration	0 - 30 sec	15 sec	Overlap timer for when pumps are rotating from one another
XDU.021	Pump Sequence	0 = Auto 1 = Pump 1 2 = Pump 2	(0) Auto	Specifies which is the lead pump. If configured for auto, pumps will rotate for equal runtime purposes based off a set schedule
XDU.027	Pump Rotation Frequency	0 - 30 days	7 days	Allows end user to define how often pumps should rotate
XDU.035	Flow Switch Time Delay	1 - 9999 sec	20 sec	
XDU.052	Minimum Fluid Flow Volume	1.0 - 1000.0 l/m	5.0 l/m	Allows end user to specify minimum Fluid Flow
XDU.053	Perform Pump Rotation	0 = No 1 = Yes	(0) No	Allows end user to force a pump rotation

B.2 Line IDs for Alarm Setting Parameters

Table B.3 User Menu Alarm Settings by Line ID

Line ID	Parameter Name	Range	Default Setting	Description
U202	Return Sensor Alarms	Disabled Enabled	Enabled	Enables or disables the return sensor alarms. When enabled, the return temperature and humidity values will be compared to a high & low setting.
U203	High Return Temperature	34 - 210°F 1.0 - 99.0 °C	100 °F	Allows a user to adjust the point at which the actual return temperature activates a High Temperature Alarm.
U204	Low Return Temperature	34 - 210°F 1.0 - 99.0 °C	65 °F	Allows a user to adjust the point at which the actual return temperature activates the Low Temperature Alarm.
U205	High Return Humidity	1.0 - 99.0 %	65.0%	Allows a user to adjust the point at which the actual return humidity activates the High Humidity Alarm.
U206	Low Return Humidity	1.0 - 99.0 %	35.0%	Allows a user to adjust the point at which the actual return humidity activates the Low Humidity Alarm.
U207	Sensor A Alarms	Disabled Enabled	Disabled	Enables or disables the alarms for reference Sensor A. When enabled, the Sensor A temperature and humidity values will be compared to a high and low setting.
U208	High Temperature Sensor A	34 - 210°F 1.0 - 99.0 °C	90 °F	Allows a user to adjust the point at which the actual Sensor A temperature activates a High Temperature Alarm.
U209	Low Temperature Sensor A	34 - 210°F 1.0 - 99.0 °C	55 °F	Allows a user to adjust the point at which the actual Sensor A temperature activates a Low Temperature Alarm.

Table B.3 User Menu Alarm Settings by Line ID (continued)

Line ID	Parameter Name	Range	Default Setting	Description
U210	High Humidity Sensor A	1.0 - 99.0 %	70.0%	Allows a user to adjust the point at which the actual Sensor A humidity activates a High Humidity Alarm.
U211	Low Humidity Sensor	1.0 - 99.0 %	30.0%	Allows a user to adjust the point at which the actual Sensor A humidity activates a Low Humidity Alarm.
U213	Supply Sensor Alarms	Disabled Enabled	Disabled	Enables or disables the supply sensor alarms. When enabled, the supply temperature value will be compared to a high and low setting.
U214	High Supply Temperature	34 - 210°F 1.0 - 99.0 °C	75 °F	Sets the temperature at which the High Supply Temperature Alarm is activated.
U215	Low Supply Temperature	34 - 210°F 1.0 - 99.0 °C	50 °F	Sets the temperature at which the Low Supply Temperature Alarm is activated.
U219	Remote Sensor Alarms	0 = Disabled 1 = Com Set 2 = Sep Set	Disabled	Enables or disables the remote sensor alarms. When enabled, the remote temperature values will be compared to a high and low setting.
U220	High Remote Temperature	34 - 210°F 1.0 - 99.0 °C	90 °F	Enables or disables remote sensor temperature alarms. When enabled, the high and low remote temperature alarm will allow a user to adjust the point at which the actual remote temperature activates a High/Low temperature alarm. This parameter is used when common alarm points will be shared by all sensors. Otherwise, the remote sensors can be set individually.
	Low Remote Temperature	34 - 210°F 1.0 - 99.0 °C	55 °F	
U224- U233	High Remote 01-10 Low Remote 01-10	34 - 210°F 1.0 - 99.0 °C 34 - 210°F 1.0 - 99.0 °C	90 °F 55 °F	Sets the high and low remote temperature sensor alarm points individually for each sensor when the parameter separate thresholds is set to disabled
U235	Static Pressure Messages	Disabled Enabled	Disabled	Enables or disables static pressure messages.
U236	High Static Pressure (inWC)	0.010 - 1.405 inWC	1.284 inWC	Sets the pressure at which the High Static Pressure Alarm is activated (inWC, Pa)
	High Static Pressure (Pa)	2 - 350 Pa	320 Pa	
U237	Low Static Pressure (inWC)	0.000 - 1.395 inWC	0.000 inWC	Sets the pressure at which the Low Static Pressure Alarm is activated (inWC, Pa)
	Low Static Pressure (Pa)	0 - 348 Pa	0 Pa	
U238	SP Messages During Unit Off	No Yes	No	Enables or disables Static Pressure messages when the unit is OFF
U239	SP Messages on Fan Adjust	No Yes	No	Enables or disables the static pressure messages when the fan has been adjusted due to special events. These events include an adjustment for heating, humidification, dehumidification, motor overload / EC fan fault or loss of airflow.

Table B.3 User Menu Alarm Settings by Line ID (continued)

Line ID	Parameter Name	Range	Default Setting	Description
U240	SP Transducer High Range (inWC)	0.000 - 1.405 inWC	1.284 inWC	Sets the pressure range at which the High Static Pressure Out of Range alarm is activated.
	SP Transducer High Range (Pa)	0 - 350 Pa	320 Pa	
U241	SP Transducer Low Range (inWC)	0.000 - 1.395 inWC	0.000 inWC	Sets the pressure range at which the Low Static Pressure Out of Range alarm is activated.
	SP Transducer Low Range (Pa)	0 - 348 Pa	0 Pa	

Table B.4 Service Menu Alarm Settings by Line ID

Line ID	Parameter Name	Range	Default Setting	Description
S202	Return Sensor Alarms Enable	Disabled Enabled	Enabled	Enables or disables the return temperature and humidity sensor alarms.
	Return Sensor Alarms Init Delay	10 - 9999 sec	90 sec	
S203	High Return Temperature Alarm	34 - 210 °F 1.0 - 99.0 °C	100 °F	Sets the temperature threshold for the High/Low Return Temperature alarms.
	Low Return Temperature Alarm	34 - 210 °F 1.0 - 99.0 °C	65 °F	
S204	High Return Humidity Alarm	1.0 - 99.0 %	0.65	Sets the humidity threshold for the High/Low Return Temperature alarms.
	Low Return Humidity Alarm	1.0 - 99.0 %	0.35	
S205	Sensor A Alarms Enable	Disabled Enabled	Disabled	Enables or disables the alarms associated with Sensor A and sets the time delay before the alarm is annunciated.
	Sensor A Alarms Init Delay	10 - 9999 sec	90 sec	
S206	Sensor A Low Temperature Alarm	34 - 210 °F 1.0 - 99.0 °C	55 °F	Sets the temperature threshold when Sensor A High/Low Temperature alarm will occur
	Sensor A High Temperature Alarm	34 - 210 °F 1.0 - 99.0 °C	90 °F	
S207	Sensor A Low Humidity Alarm	1.0 - 99.0%	30.0%	Sets the temperature threshold when Sensor A High/Low Humidity alarm will occur
	Sensor A High Humidity Alarm	1.0 - 99.0%	70.0%	
S208	Warning Activates Alarm Relay	No Yes	Yes	When set for 'Yes', a "Warning" event-type will activate the Alarm Relay in addition to an "Alarm" event-type.

Table B.4 Service Menu Alarm Settings by Line ID (continued)

Line ID	Parameter Name	Range	Default Setting	Description
S209	K11 (WA Relay) Active On	0 = Dehum 1 = Warning 2 = Emergency Pwr 3 = Free cooling 4 = FC Start	Warning	The Warning Relay (WA Relay) can be activated for different purposes; during a Call of Dehumidification, during a 'Warning' event- type, when unit is on Emergency Power and a Customer Input Alarm is configured for 'Emergency Pwr', during Free cooling, or during Freecooling (FC) Start.
S210	K11(WA Relay) and AL Relay	Direct Reverse	Direct	Determines whether the K11 (WA Relay) is Direct or Reverse acting.
S211	Water Alarm Shuts Down Unit	No Yes	No	The controller can be configured to shut the following down during an active 'Water Alarm': <ul style="list-style-type: none">• Shutdown the entire unit• Shutdown Humidification operation
	Water Alarm Hum Fill Down	No Yes	No	
S21A	Loss of Flow Compressor Timer	0 - 180 sec	0 sec	Allows setting a maximum pump down time during a loss of flow condition to prevent causing a high-pressure alarm due to pump down with no water/glycol flow to the condenser; hidden unless pump down is enabled; applies only to water/glycol cooled systems
S21B	Loss of Flow Threshold	0 - 100 %	0.1	Sets the threshold for call for cooling (CFC) loss of flow.
S213	Supply Sensor Alarms Enable	Disabled Enabled	Disabled	Enables or disables the supply sensor alarms. If the unit is not equipped with a supply temperature sensor, then this parameter will show 'Disabled'. A user may also select the time delay before the alarm will become active.
	Supply Sensor Alarms Init Delay	10 - 9999 sec	90 sec	
S214	High Supply Temperature	34 - 210 °F 1.0 - 99.0 °C	75 °F	Sets the high & low supply temperature threshold that the alarms will be triggered at.
	Low Supply Temperature	34 - 210 °F 1.0 - 99.0 °C	50 °F	
S215	Dew Point Alarms Enable	Disabled Enabled	Disabled	Enables or disables the Return Air Dew Point alarm. Dew Point alarms can be enabled with any humidity control type. Dew point alarms may be used with or without humidification or dehumidification options selected. A user may adjust the time delay before the alarm is activated.
	Dew Point Alarms Init Delay	10 - 9999 sec	90 sec	
S216	High Dew Point	34 - 210 °F 1.0 - 99.0 °C	59 °F	Sets the high/low dew point threshold.
	Low Dew Point	34 - 210 °F 1.0 - 99.0 °C	39 °F	
S217	Sensor A Dew Point Alarms Enable	Disabled Enabled	Disabled	Enables or disables the optional Sensor A Dew Point alarm. Dew Point alarms can be enabled with any humidity control type. Dew point alarms may be used with or without humidification or dehumidification options selected. A user may adjust the time delay before the alarm is activated.
	Sensor A Dew Point Alarms Init Delay	10 - 9999 sec	90 sec	
S218	High Dew Point Sensor A	34 - 210 °F 1.0 - 99.0 °C	62 °F	Sets the high/low Sensor A dew point thresholds.
	Low Dew Point Sensor A	34 - 210 °F 1.0 - 99.0 °C	36 °F	

Table B.4 Service Menu Alarm Settings by Line ID (continued)

Line ID	Parameter Name	Range	Default Setting	Description
S219	Remote Sensor Alarms Enable	0 = Disabled 1 = Com Set 2 = Sep Set	Disabled	Disable prevents remote temperature sensor alarms from occurring. Com Set or common setting allows remote alarm activation based on a common alarm setting. Sep Set, or separate setting allows the user to program unique temperature alarm settings. A user may adjust the time delay before the alarm is activated.
	Remote Sensor Alarms Init Delay	10 - 9999 sec	180 sec	
S220	High Remote Temperature	34 - 210 °F 1.0 - 99.0 °C	90 °F	Sets the high/low Remote Sensor alarm thresholds.
	Low Remote Temperature	34 - 210 °F 1.0 - 99.0 °C	55 °F	
S222	EEV Alarmboard	0 = NO 1 = NC	1 (NC)	
S22A	Operation on Sensor Failure	0 = Cooling 1 = Shutdown	0 (Cooling)	Selects function to occur if the temperature control sensor fails.
	Operation on Sensor Failure Cooling Mode	0 = Full 1 = Hold	0 (Full)	Full = Full CFC Hold = hold last CFC
S224 - S233, S23A,	Customer Input 1 - 11	0 = Smoke 1 = Water Alarm 2 = C PMP Alarm 3 = Flow Alarm 4 = Stdby G Pump 5 = Stdby Unit 6 = C-Input 1 7 = C-Input 2 8 = C-Input 3 9 = C-Input 4 10 = Rht Lockout 11 = Hum Lockout 12 = Rht+Hum Lock 13 = Comp Lockout 14 = Call Service 15 = High Temp 16 = Air Loss 17 = FC Lockout 18 = Heater Alarm 19 = Flow AL SD 20 = Flow AL LC	1 (Water Alarm) for inputs 1-4 38 (Not Used) for inputs 5-11	Selects the device and operation of the Customer Inputs. Each event reflects a different alarm scenario and possible action to the unit. A user may select whether the customer input is normally-open or normally-closed. If the parameter is configured for 'Factory STD.', then it indicates that this input is factory-configured and is not configurable in the field.

Table B.4 Service Menu Alarm Settings by Line ID (continued)

Line ID	Parameter Name	Range	Default Setting	Description
S224 - S233, S23A, (Cont'd)	Customer Input 1 - 11 (Cont'd)	21 = Comp Lock PD 22 = Enable FC 23 = HTRJ VFD 24 = HTRJ SPD 25 = Fire Alarm 26 = 2nd Setpoint 27 = Emergency Pwr 28 = LSI 29 = Cond 1 Fail 30 = Cond 2 Fail 31 = D-Scroll Red 32 = Swap Valve 33 = EC Fan Fault 34 = Eco Airflow 35 = Damper Switch 36 = Power A 37 = Power B 38 = Not Used 39 = Flow AL LFC 40 = Hand Mode 41 = Fan Overrd. 42 = Cool Overrd	1 (Water Alarm) for inputs 1-4 38 (Not Used) for inputs 5-11	Selects the device and operation of the Customer Inputs. Each event reflects a different alarm scenario and possible action to the unit. A user may select whether the customer input is normally-open or normally-closed. If the parameter is configured for 'Factory STD', then it indicates that this input is factory-configured and is not configurable in the field.
S224 - S233, S23A, (Cont'd)	Customer Input Active open/closed	Closed Open	Closed	A user may select if the customer input is active when contacts are open or closed
S236	Event Delay Time (sec)	10 - 9999 sec	10 sec	Main Fan Overload
	Event Enabled	Disabled Enabled	Enabled	
	Event: MAIN FAN OVERLOAD	MESSAGE WARNING ALARM	ALARM	
S237	Initial Loss of Airflow Delay	10 - 600 sec	30 sec	Loss of Airflow
	Event Delay Time (sec)	10 - 9999 sec	30 sec	
	Event Enabled	Disabled Enabled	Enabled	
	Event: LOSS OF AIRFLOW	MESSAGE WARNING ALARM	ALARM	
S238	Event Delay Time (sec)	10 - 9999 sec	10 sec	Clogged Filters
	Event Enabled	Disabled Enabled	Enabled	
	Event: CLOGGED FILTERS	MESSAGE WARNING ALARM	WARNING	
S239	Event Delay Time (sec)	10 - 9999 sec	30 sec	High Room Temperature
	Event Enabled	Disabled Enabled	Enabled	
	Event: HIGH ROOM TEMP	MESSAGE WARNING ALARM	WARNING	

Table B.4 Service Menu Alarm Settings by Line ID (continued)

Line ID	Parameter Name	Range	Default Setting	Description
S240	Event Delay Time (sec)	10 - 9999 sec	30 sec	Low Room Temperature
	Event Enabled	Disabled Enabled	Enabled	
	Event: LOW ROOM TEMP	MESSAGE WARNING ALARM	WARNING	
S241	Event Delay Time (sec)	10 - 9999 sec	30 sec	High Room Humidity
	Event Enabled	Disabled Enabled	Enabled	
	Event: HIGH ROOM HUM	MESSAGE WARNING ALARM	WARNING	
S242	Event Delay Time (sec)	10 - 9999 sec	30 sec	Low Room Humidity
	Event Enabled	Disabled Enabled	Enabled	
	Event: LOW ROOM HUM	MESSAGE WARNING ALARM	WARNING	
S243	Event Delay Time (sec)	10 - 9999 sec	30 sec	High Temperature Sensor A
	Event Enabled	Disabled Enabled	Disabled	
	Event: HIGH TEMP SENSOR A	MESSAGE WARNING ALARM	WARNING	
S244	Event Delay Time (sec)	10 - 9999 sec	30 sec	Low Temperature Sensor A
	Event Enabled	Disabled Enabled	Disabled	
	Event: LOW TEMP SENSOR A	MESSAGE WARNING ALARM	WARNING	
S245	Event Delay Time (sec)	10 - 9999 sec	30 sec	High Humidity Sensor A
	Event Enabled	Disabled Enabled	Disabled	
	Event: HIGH HUM SENSOR A	MESSAGE WARNING ALARM	WARNING	
S246	Event Delay Time (sec)	10 - 9999 sec	30 sec	Low Humidity Sensor A
	Event Enabled	Disabled Enabled	Disabled	
	Event: LOW HUM SENSOR A	MESSAGE WARNING ALARM	WARNING	
S249	Event Delay Time (sec)	—	—	Compressor 1 Overload
	Event Enabled	Disabled Enabled	Enabled	
	Event: COMP 1 OVERLOAD	MESSAGE WARNING ALARM	ALARM	
S250	Event Delay Time (sec)	—	—	Compressor 2 Overload
	Event Enabled	Disabled Enabled	Enabled	
	Event: COMP 2 OVERLOAD	MESSAGE WARNING ALARM	ALARM	

Table B.4 Service Menu Alarm Settings by Line ID (continued)

Line ID	Parameter Name	Range	Default Setting	Description
S251	Event Delay Time (sec)	—	—	Circuit 1 High Pressure
	Event Enabled	Disabled Enabled	Enabled	
	Event: CIRCUIT 1 HIGH PRESS	MESSAGE WARNING ALARM	ALARM	
S252	Event Delay Time (sec)	—	—	Circuit 2 High Pressure
	Event Enabled	Disabled Enabled	Enabled	
	Event: CIRCUIT 2 HIGH PRESS	MESSAGE WARNING ALARM	ALARM	
S253	Event Delay Time (sec)	—	—	Circuit 1 Low Pressure
	Event Enabled	Disabled Enabled	Enabled	
	Event: CIRCUIT 1 LOW PRESS	MESSAGE WARNING ALARM	ALARM	
S254	Event Delay Time (sec)	—	—	Circuit 2 Low Pressure
	Event Enabled	Disabled Enabled	Enabled	
	Event: CIRCUIT 2 LOW PRESS	MESSAGE WARNING ALARM	ALARM	
S255	Event Delay Time (sec)	—	—	Circuit 1 Pump down Failure
	Event Enabled	Disabled Enabled	Enabled	
	Event: CIRCUIT 1 PUMPD. FAIL	MESSAGE WARNING ALARM	ALARM	
S256	Event Delay Time (sec)	—	—	Circuit 2 Pump down Failure
	Event Enabled	Disabled Enabled	Enabled	
	Event: CIRCUIT 2 PUMPD. FAIL	MESSAGE WARNING ALARM	ALARM	
S257	Event Delay Time (sec)	—	—	Digital Scroll 1 High Temperature
	Event Enabled	Disabled Enabled	Enabled	
	Event: DIG SCROLL1 HIGH TEMP	MESSAGE WARNING ALARM	ALARM	
S258	Event Delay Time (sec)	—	—	Digital Scroll 2 High Temperature
	Event Enabled	Disabled Enabled	Enabled	
	Event: DIG SCROLL2 HIGH TEMP	MESSAGE WARNING ALARM	ALARM	
S259	Event Reset Type	0 = AR 1 = MR	0 (AR)	Electric Heat High Temp AR = Auto Reset, MR = Manual Reset
	Event Delay Time (sec)	10 - 9999 sec	10 sec	
	Event Enabled	Disabled Enabled	Enabled	
	Event: EL HEAT HIGH TEMP	MESSAGE WARNING ALARM	ALARM	

Table B.4 Service Menu Alarm Settings by Line ID (continued)

Line ID	Parameter Name	Range	Default Setting	Description
S262	Event Delay Time (sec)	10 - 9999 sec	10 sec	Working HRS Exceeded
	Event Enabled	Disabled Enabled	Enabled	
	Event: UNIT HRS EXCEEDED	MESSAGE WARNING ALARM	WARNING	
S263	Event Delay Time (sec)	10 - 9999 sec	10 sec	Smoke Detected
	Event Enabled	Disabled Enabled	Enabled	
	Event: SMOKE DETECTED	MESSAGE WARNING ALARM	ALARM	
S264	Event Delay Time (sec)	10 - 9999 sec	10 sec	Water Under Floor
	Event Enabled	Disabled Enabled	Enabled	
	Event: WATER UNDER FLOOR	MESSAGE WARNING ALARM	ALARM	
S265	Event Delay Time (sec)	10 - 9999 sec	10 sec	Cond Pump High Water
	Event Enabled	Disabled Enabled	Enabled	
	Event: COND PUMP-HIGH WATER	MESSAGE WARNING ALARM	ALARM	
S266	Event Delay Time (sec)	0 = AR 1 = MR	0 (AR)	Loss of Flow AR = Auto Reset MR = Manual Reset
	Event Enabled	10 - 9999 sec	10 sec	
	Event Number 107 Enabled	Disabled Enabled	Enabled	
	Event: LOSS OF FLOW	MESSAGE WARNING ALARM	ALARM	
S267	Event Delay Time (sec)	10 - 9999 sec	10 sec	Standby Glycol Pump ON
	Event Enabled	Disabled Enabled	Enabled	
	Event: STANDBY GLYCOL PUMP ON	MESSAGE WARNING ALARM	ALARM	
S268	Event Delay Time (sec)	10 - 9999 sec	10 sec	Standby Unit ON
	Event Enabled	Disabled Enabled	Enabled	
	Event: STANDBY UNIT ON	MESSAGE WARNING ALARM	ALARM	
S269	Event Delay Time (sec)	10 - 9999 sec	10 sec	Humidifier Problem
	Event Enabled	Disabled Enabled	Enabled	
	Event: HUMIDIFIER PROBLEM	MESSAGE WARNING ALARM	ALARM	

Table B.4 Service Menu Alarm Settings by Line ID (continued)

Line ID	Parameter Name	Range	Default Setting	Description
S270	Event Delay Time (sec)	10 - 9999 sec	300 sec	No Connection w/ Unit 1
	Event Enabled	Disabled Enabled	Enabled	
	Event: NO CONNECTION W/ UNIT1	MESSAGE WARNING ALARM	WARNING	
S271	Event Delay Time (sec)	—	—	Unit X Disconnected
	Event Enabled	Disabled Enabled	Enabled	
	Event: UNIT 01 DISCONNECTED	MESSAGE WARNING ALARM	WARNING	
S272	Event: Loss of power Autoreset Delay	60 - 3600 sec	300 sec	Loss of Power
	Event Enabled	Disabled Enabled	Enabled	
	Event: LOSS OF POWER	MESSAGE WARNING ALARM	WARNING	
S275	Event Delay Time (sec)	10 - 9999 sec	10 sec	Customer Input 1
	Event Enabled	Disabled Enabled	Enabled	
	Event: CUSTOMER INPUT 1	MESSAGE WARNING ALARM	ALARM	
S276	Event Delay Time (sec)	10 - 9999 sec	10 sec	Customer Input 2
	Event Enabled	Disabled Enabled	Enabled	
	Event: CUSTOMER INPUT 2	MESSAGE WARNING ALARM	ALARM	
S277	Event Delay Time (sec)	10 - 9999 sec	10 sec	Customer Input 3
	Event Enabled	Disabled Enabled	Enabled	
	Event: CUSTOMER INPUT 3	MESSAGE WARNING ALARM	ALARM	
S278	Event Delay Time (sec)	10 - 9999 sec	10 sec	Customer Input 4
	Event Enabled	Disabled Enabled	Enabled	
	Event: CUSTOMER INPUT 4	MESSAGE WARNING ALARM	ALARM	
S279	Event Delay Time (sec)	10 - 9999 sec	10 sec	Call Service
	Event Enabled	Disabled Enabled	Enabled	
	Event: CALL SERVICE	MESSAGE WARNING ALARM	ALARM	
S280	Event Delay Time (sec)	10 - 9999 sec	10 sec	High Temperature
	Event Enabled	Disabled Enabled	Enabled	

Table B.4 Service Menu Alarm Settings by Line ID (continued)

Line ID	Parameter Name	Range	Default Setting	Description
	Event: HIGH TEMPERATURE	MESSAGE WARNING ALARM	ALARM	
S281	Event Delay Time (sec)	10 - 9999 sec	10 sec	Loss of Air Blower 1
	Event Enabled	Disabled Enabled	Disabled	
	Event: LOSS OF AIR BLOWER 1	MESSAGE WARNING ALARM	ALARM	
S282	Event Delay Time (sec)	10 - 9999 sec	10 sec	Reheat Lockout
	Event Enabled	Disabled Enabled	Enabled	
	Event: REHEAT LOCKOUT	MESSAGE WARNING ALARM	WARNING	
S283	Event Delay Time (sec)	10 - 9999 sec	10 sec	Humidifier Lockout
	Event Enabled	Disabled Enabled	Enabled	
	Event: HUMIDIFIER LOCKOUT	MESSAGE WARNING ALARM	WARNING	
S284	Event Delay Time (sec)	10 - 9999 sec	10 sec	FC Lockout
	Event Enabled	Disabled Enabled	Enabled	
	Event: FC LOCKOUT	MESSAGE WARNING ALARM	WARNING	
S285	Compressor Lockout Option	0 = ALL 1 = 1 (A) 2 = 2 (A) 3 = 1B 4 = 2B 5 = 1A + 2A 6 = 1B + 2B 7 = 1A + 1B 8 = 2A + 2B	0(ALL)	Compressor(s) Lockout
	Event Delay Time (sec)	10 - 9999 sec	10 sec	
	Event Enabled	Disabled Enabled	Enabled	
	Event: COMPRESSOR (S) LOCKOUT	MESSAGE WARNING ALARM	WARNING	
S27B	Edit Cust Input 1	(20 digits) 0-9 A-Z a-z &* / . + - _ : @ \	CUSTOMER INPUT 1	Edit Customer Input 1 Text
S27C	Edit Cust Input 2	(20 digits) 0-9 A-Z a-z &* / . + - _ : @ \	CUSTOMER INPUT 2	Edit Customer Input 2 Text

Table B.4 Service Menu Alarm Settings by Line ID (continued)

Line ID	Parameter Name	Range	Default Setting	Description
S27D	Edit Cust Input 3	(20 digits) 0-9 A-Z a-z &* / . + - _ : @ \	CUSTOMER INPUT 3	Edit Customer Input 3 Text
S27E	Edit Cust Input 4	(20 digits) 0-9 A-Z a-z &* / . + - _ : @ \	CUSTOMER INPUT 4	Edit Customer Input 4 Text
S288	Event Delay Time (sec)	10 - 9999 sec	10 sec	Compressor 1 Short Cycle
	Event Enabled	Disabled Enabled	Enabled	
	Event: COMP 1 SHORT CYCLE	MESSAGE WARNING ALARM	WARNING	
S289	Event Delay Time (sec)	10 - 9999 sec	10 sec	Compressor 2 Short Cycle
	Event Enabled	Disabled Enabled	Enabled	
	Event: COMP 2 SHORT CYCLE	MESSAGE WARNING ALARM	WARNING	
S290	Event Delay Time (sec)	10 - 9999 sec	10 sec	Emergency Power
	Event Enabled	Disabled Enabled	Enabled	
	Event: EMERGENCY POWER	MESSAGE WARNING ALARM	WARNING	
S291	Event Delay Time (sec)	10 - 9999 sec	10 sec	Condenser 1 Failure
	Event Enabled	Disabled Enabled	Enabled	
	Event: CONDENSER 1 FAILURE	MESSAGE WARNING ALARM	WARNING	
S292	Event Delay Time (sec)	10 - 9999 sec	10 sec	Condenser 2 Failure
	Event Enabled	Disabled Enabled	Enabled	
	Event: CONDENSER 2 FAILURE	MESSAGE WARNING ALARM	WARNING	
S293	Event Delay Time (sec)	10 - 9999 sec	15 sec	EC Fan Fault
	Event Enabled	Disabled Enabled	Enabled	
	Event: EC FAN FAULT	MESSAGE WARNING ALARM	ALARM	
S294	Event Delay Time (sec)	10 - 9999 sec	30 sec	High Supply Temperature
	Event Enabled	Disabled Enabled	Enabled	
	Event: HI SUPPLY TEMPERATURE	MESSAGE WARNING ALARM	WARNING	

Table B.4 Service Menu Alarm Settings by Line ID (continued)

Line ID	Parameter Name	Range	Default Setting	Description
S295	Event Delay Time (sec)	10 - 9999 sec	30 sec	Low Supply Temperature
	Event Enabled	Disabled Enabled	Enabled	
	Event: LO SUPPLY TEMPERATURE	MESSAGE WARNING ALARM	WARNING	
S296	Event Delay Time (sec)	10 - 9999 sec	10 sec	Reduced Eco Airflow
	Event Enabled	Disabled Enabled	Enabled	
	Event: REDUCED ECO AIRFLOW	MESSAGE WARNING ALARM	WARNING	
S297	Event Delay Time (sec)	10 - 9999 sec	10 sec	Eco High Temperature Override
	Event Enabled	Disabled Enabled	Enabled	
	Event: ECO HI TEMP OVERRIDE	MESSAGE WARNING ALARM	WARNING	
S298	Event Delay Time (sec)	10 - 9999 sec	10 sec	Temperature Control Sensor Fail
	Event Enabled	Disabled Enabled	Enabled	
	Event: TEMP CTRL SENSOR FAIL	MESSAGE WARNING ALARM	ALARM	
S2A2	Event Delay Time (sec)	10 - 9999 sec	30 sec	High Dew Point
	Event Enabled	Disabled Enabled	Enabled	
	Event: HIGH DEW POINT	MESSAGE WARNING ALARM	WARNING	
S2A3	Event Delay Time (sec)	10 - 9999 sec	30 sec	Low Dew Point
	Event Enabled	Disabled Enabled	Enabled	
	Event: LOW DEW POINT	MESSAGE WARNING ALARM	WARNING	
S2A4	Event Delay Time (sec)	10 - 9999 sec	30 sec	High Dew Point Sensor A
	Event Enabled	Disabled Enabled	Enabled	
	Event: HI DEW POINT SENSOR A	MESSAGE WARNING ALARM	WARNING	
S2A5	Event Delay Time (sec)	10 - 9999 sec	30 sec	Low Dew Point Sensor A
	Event Enabled	Disabled Enabled	Enabled	
	Event: LOW DEW POINT SENSOR A	MESSAGE WARNING ALARM	WARNING	
S2A6	Event Delay Time (sec)	10 - 9999 sec	30 sec	High Remote Sensor
	Event Enabled	Disabled Enabled	Enabled	
	—	MESSAGE WARNING ALARM	WARNING	

Table B.4 Service Menu Alarm Settings by Line ID (continued)

Line ID	Parameter Name	Range	Default Setting	Description
S2A7	Event Delay Time (sec)	10 - 9999 sec	30 sec	Low Remote Sensor
	Event Enabled	Disabled Enabled	Enabled	
	—	MESSAGE WARNING ALARM	WARNING	
S2A8	Event Delay Time (sec)	10 - 9999 sec	10 sec	Power A Failure
	Event Enabled	Disabled Enabled	Enabled	
	Event: POWER 'A' FAILURE	MESSAGE WARNING ALARM	ALARM	
S2A9	Event Delay Time (sec)	10 - 9999 sec	10 sec	Power B Failure
	Event Enabled	Disabled Enabled	Enabled	
	Event: POWER 'B' FAILURE	MESSAGE WARNING ALARM	ALARM	
S2B1	Event Delay Time (sec)	10 - 9999 sec	10 sec	Airflow Sensor Failure
	Event Enabled	Disabled Enabled	Enabled	
	Event: AIRFLOW SENSOR FAIL	MESSAGE WARNING ALARM	WARNING	
S2B2	Event Delay Time (sec)	10 - 9999 sec	30 sec	Humidity Control Sensor Failure
	Event Enabled	Disabled Enabled	Enabled	
	Event: HUM CTRL SENSOR FAILURE	MESSAGE WARNING ALARM	WARNING	
S2B6	Event Delay Time (sec)	10 - 9999 sec	120 sec	Low Static Pressure
	Event Enabled	Disabled Enabled	Disabled	
	Event: LOW STATIC PRESSURE	MESSAGE WARNING ALARM	WARNING	
S2B7	Event Delay Time (sec)	10 - 9999 sec	120 sec	High Static Pressure
	Event Enabled	Disabled Enabled	Disabled	
	Event: HIGH STATIC PRESSURE	MESSAGE WARNING ALARM	WARNING	
S2B8	Event Delay Time (sec)	10 - 9999 sec	150 sec	Static Pressure 1 Out of Range
	Event Enabled	Disabled Enabled	Disabled	
	Event: STATPR 1 OUT OF RANGE	MESSAGE WARNING ALARM	WARNING	
S2B9	Event Delay Time (sec)	10 - 9999 sec	150 sec	Static Pressure 2 Out of Range
	Event Enabled	Disabled Enabled	Disabled	
	Event: STATPR 2 OUT OF RANGE	MESSAGE WARNING ALARM	WARNING	

Table B.4 Service Menu Alarm Settings by Line ID (continued)

Line ID	Parameter Name	Range	Default Setting	Description
S2C1	Event Delay Time (sec)	10 - 9999 sec	150 sec	Static Pressure 3 Out of Range
	Event Enabled	Disabled Enabled	Disabled	
	Event: STATPR 3 OUT OF RANGE	MESSAGE WARNING ALARM	WARNING	
S2C2	Event Delay Time (sec)	10 - 9999 sec	150 sec	Static Pressure 4 Out of Range
	Event Enabled	Disabled Enabled	Disabled	
	Event: STATPR 4 OUT OF RANGE	MESSAGE WARNING ALARM	WARNING	
S2C3	Event Delay Time (sec)	10 - 9999 sec	120 sec	Static Pressure 1 Sensor Failure
	Event Enabled	Disabled Enabled	Disabled	
	Event: STAT PR 1 SENS FAIL	MESSAGE WARNING ALARM	ALARM	
S2C4	Event Delay Time (sec)	10 - 9999 sec	120 sec	Static Pressure 2 Sensor Failure
	Event Enabled	Disabled Enabled	Disabled	
	Event: STAT PR 2 SENS FAIL	MESSAGE WARNING ALARM	ALARM	
S2C5	Event Delay Time (sec)	10 - 9999 sec	120 sec	Static Pressure 3 Sensor Failure
	Event Enabled	Disabled Enabled	Disabled	
	Event: STAT PRES 3 SENS FAIL	MESSAGE WARNING ALARM	ALARM	
S2C6	Event Delay Time (sec)	10 - 9999 sec	120 sec	Static Pressure 4 Sensor Failure
	Event Enabled	Disabled Enabled	Disabled	
	Event: STAT PRES 4 SENS FAIL	MESSAGE WARNING ALARM	ALARM	
S2D1	Event Delay Time (sec)	10 - 9999 sec	10 sec	Compressor 1A Overload
	Event Enabled	Disabled Enabled	Enabled	
	Event: COMP 1A OVERLOAD	MESSAGE WARNING ALARM	ALARM	
S2D2	Event Delay Time (sec)	10 - 9999 sec	10 sec	Compressor 1B Overload
	Event Enabled	Disabled Enabled	Enabled	
	Event: COMP 1B OVERLOAD	MESSAGE WARNING ALARM	ALARM	
S2D3	Event Delay Time (sec)	10 - 9999 sec	10 sec	Compressor 2A Overload
	Event Enabled	Disabled Enabled	Enabled	
	Event: COMP 2A OVERLOAD	MESSAGE WARNING ALARM	ALARM	

Table B.4 Service Menu Alarm Settings by Line ID (continued)

Line ID	Parameter Name	Range	Default Setting	Description
S2D4	Event Delay Time (sec)	10 - 9999 sec	10 sec	Compressor 2B Overload
	Event Enabled	Disabled Enabled	Enabled	
	Event: COMP 2B OVERLOAD	MESSAGE WARNING ALARM	ALARM	
S2D5	Event Delay Time (sec)	10 - 9999 sec	10 sec	Compressor 1A High Temperature
	Event Enabled	Disabled Enabled	Enabled	
	Event: COMP 1A HIGH TEMP	MESSAGE WARNING ALARM	ALARM	
S2D6	Event Delay Time (sec)	10 - 9999 sec	10 sec	Compressor 1B High Temperature
	Event Enabled	Disabled Enabled	Enabled	
	Event: COMP 1B HIGH TEMP	MESSAGE WARNING ALARM	ALARM	
S2D7	Event Delay Time (sec)	10 - 9999 sec	10 sec	Compressor 2A High Temperature
	Event Enabled	Disabled Enabled	Enabled	
	Event: COMP 2A HIGH TEMP	MESSAGE WARNING ALARM	ALARM	
S2D8	Event Delay Time (sec)	10 - 9999 sec	10 sec	Compressor 2B High Temperature
	Event Enabled	Disabled Enabled	Enabled	
	Event: COMP 2B HIGH TEMP	MESSAGE WARNING ALARM	ALARM	
S2D9	Event Delay Time (sec)	10 - 9999 sec	10 sec	Compressor 1A Short Cycle
	Event Enabled	Disabled Enabled	Enabled	
	Event: COMP 1A SHORT CYCLE	MESSAGE WARNING ALARM	WARNING	
S2E1	Event Delay Time (sec)	10 - 9999 sec	10 sec	Compressor 1B Short Cycle
	Event Enabled	Disabled Enabled	Enabled	
	Event: COMP 1B SHORT CYCLE	MESSAGE WARNING ALARM	WARNING	
S2E2	Event Delay Time (sec)	10 - 9999 sec	10 sec	Compressor 2A Short Cycle
	Event Enabled	Disabled Enabled	Enabled	
	Event: COMP 2A SHORT CYCLE	MESSAGE WARNING ALARM	WARNING	
S2E5	Event Delay Time (sec)	10 - 9999 sec	10 sec	Compressor 2B Short Cycle
	Event Enabled	Disabled Enabled	Enabled	
	Event: COMP 2B SHORT CYCLE	MESSAGE WARNING ALARM	WARNING	

Table B.4 Service Menu Alarm Settings by Line ID (continued)

Line ID	Parameter Name	Range	Default Setting	Description
S2E6	Event Delay Time (sec)	10 - 9999 sec	60 sec	GCB Ambient Temperature Differential
	Event Enabled	Disabled Enabled	Enabled	
	Event: GCD AMBIENT TEMP DIFF	MESSAGE WARNING ALARM	WARNING	
S2E7	—	—	—	C1 Freeze Protection
	Event Enabled	Disabled Enabled	Enabled	
	Event: C1 FREEZE PROTECTION	MESSAGE WARNING ALARM	ALARM	
S2E8	—	—	—	C2 Freeze Protection
	Event Enabled	Disabled Enabled	Enabled	
	Event: C2 FREEZE PROTECTION	MESSAGE WARNING ALARM	ALARM	
S2E9	Event Delay Time (sec)	10 - 9999 sec	10 sec	Damper Failure
	Event Enabled	Disabled Enabled	Enabled	
	Event: DAMPER FAILURE	MESSAGE WARNING ALARM	ALARM	
SF2F	—	—	—	BMS Disconnected
	Event Enabled	Disabled Enabled	Enabled	
	Event: BMS DISCONNECTED	MESSAGE WARNING ALARM	WARNING	
S2F9	Phase Loss MB01 shuts unit down	0 = No 1 = Yes	1 (Yes)	Power 1 Phase Loss
	Event Delay Time (sec)	10 - 9999 sec	10 sec	
	Event Enabled	Disabled Enabled	Enabled	
	Event: POWER 1 PHASE LOSS	MESSAGE WARNING ALARM	ALARM	
S2G1	Phase Loss MB02 shuts unit down	0 = No 1 = Yes	1 (Yes)	Power 2 Phase Loss
	Event Delay Time (sec)	10 - 9999 sec	10 sec	
	Event Enabled	Disabled Enabled	Enabled	
	Event: POWER 2 PHASE LOSS	MESSAGE WARNING ALARM	ALARM	
S2G2	Phase Loss MB03 shuts unit down	0 = No 1 = Yes	1 (Yes)	Power 3 Phase Loss
	Event Delay Time (sec)	10 - 9999 sec	10 sec	
	Event Enabled	Disabled Enabled	Enabled	
	Event: POWER 3 PHASE LOSS	MESSAGE WARNING ALARM	ALARM	

Table B.4 Service Menu Alarm Settings by Line ID (continued)

Line ID	Parameter Name	Range	Default Setting	Description
S2G3	Phase Loss MB04 shuts unit down	0 = No 1 = Yes	1 (Yes)	Power 4 Phase Loss
	Event Delay Time (sec)	10 - 9999 sec	10 sec	
	Event Enabled	Disabled Enabled	Enabled	
	Event: POWER 4 PHASE LOSS	MESSAGE WARNING ALARM	ALARM	
S2G4	Phase Loss MB05 shuts unit down	0 = No 1 = Yes	1 (Yes)	Power 5 Phase Loss
	Event Delay Time (sec)	10 - 9999 sec	10 sec	
	Event Enabled	Disabled Enabled	Enabled	
	Event: POWER 5 PHASE LOSS	MESSAGE WARNING ALARM	ALRM	
S2G5	Phase Loss MB06 shuts unit down	0 = No 1 = Yes	1 (Yes)	Power 6 Phase Loss
	Event Delay Time (sec)	10 - 9999 sec	10 sec	
	Event Enabled	Disabled Enabled	Enabled	
	Event: POWER 6 PHASE LOSS	MESSAGE WARNING ALARM	ALARM	
S2G6	Event Delay Time (sec)	10 - 9999 sec	60 sec	Flow Sensor Fail C1
	Event Enabled	Disabled Enabled	Enabled	
	Event: FLOW SENSOR FAIL C1	MESSAGE WARNING ALARM	WARNING	
S2G7	Event Delay Time (sec)	10 - 9999 sec	60 sec	Flow Sensor Fail C2
	Event Enabled	Disabled Enabled	Enabled	
	Event: FLOW SENSOR FAIL C2	MESSAGE WARNING ALARM	WARNING	
S2G8	Event Delay Time (sec)	10 - 9999 sec	60 sec	TSA Sensor Fail
	Event Enabled	Disabled Enabled	Enabled	
	Event: TSA SENSOR FAIL	MESSAGE WARNING ALARM	ALARM	
617	Event Delay Time (sec)	1 - 9999 sec	10 sec	XDU Pump Inverter Fail 1
	Event Enabled	Disabled Enabled	Enabled	
	Event: PUMP INVERTER FAIL 1	MESSAGE WARNING ALARM	ALARM	
618	Event Delay Time (sec)	1 - 9999 sec	10 sec	XDU Pump Inverter Fail 2
	Event Enabled	Disabled Enabled	Enabled	
	Event: PUMP INVERTER FAIL 2	MESSAGE WARNING ALARM	ALARM	

Table B.4 Service Menu Alarm Settings by Line ID (continued)

Line ID	Parameter Name	Range	Default Setting	Description
619	Event Delay Time (sec)	1 - 9999 sec	10 sec	XDU Pump Flow Fail 1
	Event Enabled	Disabled Enabled	Enabled	
	Event: PUMP FLOW FAIL 1	MESSAGE WARNING ALARM	ALARM	
620	Event Delay Time (sec)	1 - 9999 sec	10 sec	XDU Pump Flow Fail 2
	Event Enabled	Disabled Enabled	Enabled	
	Event: PUMP FLOW FAIL 2	MESSAGE WARNING ALARM	ALARM	
621	Event Delay Time (sec)	1 - 9999 sec	10 sec	XDU Fluid Flow Check Filter
	Event Enabled	Disabled Enabled	Enabled	
	Event: CHECK WATER SYSTEM	MESSAGE WARNING ALARM	WARNING	
622	Event Delay Time (sec)	1 - 9999 sec	10 sec	The current XDU Supply Fluid Temperature is above the threshold
	Event Enabled	Disabled Enabled	Enabled	
	Event: HIGH SUPPLY WATER TEMP	MESSAGE WARNING ALARM	WARNING	
623	Event Delay Time (sec)	1 - 9999 sec	10 sec	The current XDU Return Fluid Temperature is above the threshold
	Event Enabled	Disabled Enabled	Enabled	
	Event: HIGH RETURN WATER TEMP	MESSAGE WARNING ALARM	WARNING	
624	Event Delay Time (sec)	1 - 9999 sec	10 sec	XDU Pump Operation with No Flow
	Event Enabled	Disabled Enabled	Enabled	
	Event: PUMP OPERATION WITH NO FLOW	MESSAGE WARNING ALARM	ALARM	
625	Event Delay Time (sec)	1 - 9999 sec	10 sec	XDU Supply Fluid Sensor Failure
	Event Enabled	Disabled Enabled	Enabled	
	Event: SUPPLY FLUID SENSOR FAILURE	MESSAGE WARNING ALARM	ALARM	
626	Event Delay Time (sec)	1 - 9999 sec	10 sec	XDU Return Fluid Sensor Failure
	Event Enabled	Disabled Enabled	Enabled	
	Event: RETURN FLUID SENSOR FAILURE	MESSAGE WARNING ALARM	ALARM	
627	Event Delay Time (sec)	1 - 9999 sec	10 sec	XDU Fluid Flow Sensor Failure
	Event Enabled	Disabled Enabled	Enabled	
	Event: FLOW SENSOR FAILURE	MESSAGE WARNING ALARM	ALARM	

Table B.4 Service Menu Alarm Settings by Line ID (continued)

Line ID	Parameter Name	Range	Default Setting	Description
628	Event Delay Time (sec)	1 - 9999 sec	-	Current working hours of fluid pump 1 are above the threshold
	Event Enabled	Disabled Enabled	Enabled	
	Event: PUMP 1 HOURS EXCEEDED	MESSAGE WARNING ALARM	WARNING	
629	Event Delay Time (sec)	1 - 9999 sec	-	Current working hours of fluid pump 2 are above the threshold
	Event Enabled	Disabled Enabled	Enabled	
	Event: PUMP 2 HOURS EXCEEDED	MESSAGE WARNING ALARM	WARNING	

B.3 Line IDs for Cascade Operation Parameters

Table B.5 Service Menu Cascade Parameters by Line ID

Line ID	Parameter Name	Range	Default Setting	Description
S515	Cascade Units	No Yes Cool/Heat Cooling Fan PI Fan speed	No	User may select the method to which the next standby unit will stage ON. <ul style="list-style-type: none"> No = disabled Yes = enabled via TW Mode 1 Cool/Heat = enabled via TW Mode 1 Cooling = enabled via TW Mode 1 Fan PI = enabled via TW Mode 3 Fan speed = enabled via TW Mode 3
S516	Cascaded Units Delay	0 - 30 min	10 min	Once a Standby unit receives an ON command from the Master (U2U 1); the amount of time that must surpass prior to the standby unit staging ON
S517	Cascaded Units Quick Start	0 - 30 min	2 min	After the Master (U2U 1) has restarted after a power-cycle; this control delay time is used (Shorter time than S516). The timer changes back to using S516 when the time of power cycle is equal to S517 min/sec. NOTE: This setting is not required. If set to a value of 0, then S517 Cascade Units Quick-Start is disable.
	Cascaded Units QS Delay	15 - 1800 sec	120 sec	
S518	Cascaded Units Control Delay	0 - 30 min	5 min	Once a standby unit has been cascaded ON; the amount of time that must surpass before the normal unit control is used.
S519	Cascaded Units OFF Delay	0 - 360 min	0 min	This timer starts to count down once a cascaded ON system has received an OFF request from the master; the cascaded unit will stop after this timer and S520 have elapsed.
S520	Cascaded Units Min Run	2 - 360 min	30 min	The minimum ON time the cascaded system will run before staging OFF, once energized.
S521	Start Next Unit at SYS Fan speed	50 - 100%	100%	When the 'System' (network) fan speed operates at or above S521, S516 timer is started. Once S516 has elapsed, the next single unit will energized. NOTE: Fan speed must be at or continuously above value set in S521; the timer restarts any time the Fan speed falls below
S522	Max. Intermediate	50 - 100 %	100%	Defines the value to which the System (network) Fan speed may increase to when not all units in the network are in operation

Table B.5 Service Menu Cascade Parameters by Line ID (continued)

Line ID	Parameter Name	Range	Default Setting	Description
	System Speed			
S523	Stop Next Unit at SYS Fanspeed	20 - 70 %	70%	when the current System (network) Fan speed operates at or below S523, two timers must elapse before the cascaded ON unit turns OFF; S519 & S520.
S524	Cascaded Units OFF Master Delay	0 - 360 min	1 min	In the event of the Virtual Master taking control; the new Master unit shall control the staging OFF of currently operating units for the amount of time set in S524. After S524 time has elapsed, S519 value is used.

This page intentionally left blank

Connect with Vertiv on Social Media



<https://www.facebook.com/vertiv/>



<https://www.instagram.com/vertiv/>



<https://www.linkedin.com/company/vertiv/>



<https://www.twitter.com/Vertiv/>



Vertiv.com | Vertiv Headquarters, 1050 Dearborn Drive, Columbus, OH, 43085, USA

© 2021 Vertiv Group Corp. All rights reserved. Vertiv™ and the Vertiv logo are trademarks or registered trademarks of Vertiv Group Corp. All other names and logos referred to are trade names, trademarks or registered trademarks of their respective owners. While every precaution has been taken to ensure accuracy and completeness here, Vertiv Group Corp. assumes no responsibility, and disclaims all liability, for damages resulting from use of this information or for any errors or omissions. Specifications, rebates and other promotional offers are subject to change at Vertiv's sole discretion upon notice.

SL-31074_REV6_11-21